

**Kotao na
BIOMASU/
Heating boiler
BIOMASS
OPERATED**

**Eco
Comfort
25**



INSTRUKCIJE/ INSTRUCTION MANUAL

Montaža, koriš enje i održavanje kotla/ *Asseby, use and maintenance of heating boiler*

Sadržaj:

1. Važna upozorenja;
 - 1.1 Minimalna udaljenost od zapaljivih materijala;
2. Opis kotla;
3. Montaža;
 - 3.1 Opšta upozorenja;
 - 3.2 Mere i uređaji bezbednosti kod kotlova ECO COMFORT;
 - 3.3 Kotlarnica;
 - 3.4 Priključenje na dimnjak;
4. Presek ECO COMFORT 25 kotla sa opisom elemenata;
5. Šema veze automatike;
6. Tabela sa tehničkim podacima;
7. Hidraulična šema;
8. Start rada kotla i održavanje;
 - 8.1 Displej automatike;
 - 8.2 Start rada kotla na biomasu;
 - 8.3 Kratko uputstvo za upotrebu automatike;
 - 8.4 Greške prilikom startovanja kotla;
 - 8.5 Održavanje kotla;
 - 8.6 Natpisna pločica;
 - 8.7 Izjave;
 - 8.8 Nalepnice;
 - 8.9 Proizvođač;
9. Garancija.

1. Važna upozorenja

OPŠTA UPOZORENJA

- Nakon uklonjenog pakovanja uveriti se u kompletnost isporuke, i u slučaju nedostataka, obratiti se prodavcu koji je prodao kotao.
- Kotao mora biti upotrebljen isključivo za namenu koju je predvideo proizvođač. Isključuje se bilo kakva odgovornost od strane proizvođača za štetu uzrokovanu osobama, životinjama ili stvarima, u slučaju grešaka pri montaži, regulaciji, održavanju ili nepravilnom korišćenju.
- U slučaju curenje vode isključiti uređaj sa električnog napajanja, zatvoriti napajanje vodom i obavestiti ovlašćeni servis ili ovlašćenog montera.
- Ovo uputstvo je sastavni deo uređaja i mora se čuvati sa pažnjom i mora **UVEK** pratiti uređaj i u slučaju promene vlasnika ili korisnika ili u slučaju priključenja na drugu instalaciju. U slučaju oštećenja ili nestanka tražiti novi primerak od ovlašćenog prodavca.



VAŽNA UPOZORENJA

Podsećamo da korišćenje uređaja na biomasu koja imaju kontakt sa električnom energijom i vodom zahtevaju poštovanje sigurnosnih mera i to:

- Zabranjeno je korišćenje kotla od strane dece i osoba sa ograničenim mogućnostima bez pratnje.
- Zabranjeno je korišćenje kotla na instalacijama sa radnom temperaturom većom od 110°C, i radnim pritiskom većim od 3 bara.
- Zabranjeno je korišćenje lako zapaljivih goriva (alkohol, nafta) radi bržeg paljenja
- Zabranjeno je odlaganje lako zapaljivih materijala u blizini kotla i u blizini vrata za loženje. Pepeo se mora odlagati u zatvorene i nezapaljive spremnike.
- Zabranjeno je spaljivanje otpada i materijala koje sagorevanje prouzrokuje plamen ili opasnost od eksplozije (npr. plastične kese, piljevinu, ugljenu prašinu, blato itd.).
- Zabranjena je bilo kakva intervencija tehničkog lica (naročito se to odnosi na zamenu grejača ili proveru ispravnosti nekog drugog el. uređaja...) ili ispuštanje, pre nego se kotao isključi i sa električnog napajanja i to izvlačenjem utičnice iz glavnog mrežnog napajanja.
- Zabranjena je izmena na sigurnosnim elementima.
- Zabranjeno je zatvaranje ventilacionih otvora na prostoriji u kojoj se nalazi kotao. Ventilacioni otvori su neophodni za pravilno sagorevanje.
- Zabranjeno je izlaganje kotla atmosferskim neprilikama. Sam kotao nije predviđen za spoljnu montažu i ne sadrži sistem protiv smrzavanja.
- Zabranjeno je isključivanje kotla ukoliko spoljna temperatura može da padne ispod NULE (opasnost od smrzavanja).

- U slučaju intervencije na bilo kom elektro uređaju kotla, ceo uređaj isključiti sa elektro instalacije i to tako što se izvadi utičnica iz mrežnog napajanja.
- Rad sa uređajem kotla zabranjen je ljudima sa posebnim potrebama (uključujući i decu) kako fizički tako i mentalnim, osim uz nadzor staratelja i ljudi koji su odgovorni za njihovo ponašanje.
- Deca moraju biti pod nadzorom staratelja kako se ne bi igrala sa uređajem kotla.
- Ako je oštećena strujna zaštita, mora biti zamenjena u samoj fabrici i servisirana od strane ovlašćenog servisera ili kvalifikovanih ljudi da bi se izbegao rizik od strujnog udara.

1.1 Minimalna udaljenost od zapaljivih materijala

- Obezbedite odgovarajuću udaljenost od zapaljivih materijala, ako je potrebno obezbediti zaštitu istih.
- Minimalna udaljenost od zapaljivih materijala je propisana zakonom- molimo da se o tome raspitate kod stručnih lica, koja se bave grejanjem, i dimnjakom.
- Minimalna udaljenost kotla i cevi za odvod dimnih gasova od slabo i prosečno gorivih materijala treba da bude najmanje 100 mm.
- Minimalno rastojanje od lako zapaljivih materijala je 200 mm, a isto važi i za materijale čija zapaljivost nije poznata.



Opasnost od požara!

- Skladištenje zapaljivih materijala i tečnosti u blizini kotla je zabranjeno.
- Obavezno upozorite korisnike o potrebnoj minimalnoj udaljenosti zapaljivih materijala od kotla.

Zapaljivost građevinskih materijala	
A ... nezapaljivi	azbest, kamen, građevinski kamen, keramičke zidne ploče, terakota, malter, cementna glazura (bez organskih dodataka)
B ... koji nisu lako zapaljivi	gipsane kartonske ploče, staklena vlakna, ploče od AKUMINA, IZOMINA, RAJOLITA, LIGNOSA, VELOKSA i HERAKLITA
C1 ... slabo gorivi	bukovo i hrastovo drvo, kompozitno drvo, filc, ploče od HOBREKSA, VERZALITA, UMAKARTA
C2 ... prosečno gorivi	drvo bora, tise i jele, kompozitni materijali
C3 ... lako zapaljivi	Asfalt, karton, celulozni materijali, iverica, pluta, poliuretani, polistiren, polipropilen, polietilen, podna vlakna

2.Opis kotla

Kotao ECO COMFORT je razvijen sa ciljem da RADIJATOR INŽENJERING ponudi tržištu kotao koji je po svojim mehani kim i termi kim osobinama izrazito namenjen biomasi kao gorivu.

Koriste i uopštenu pojam „BIOMASA“ naravno da se pre svega misli na pelet, ali treba ista i i mogu nost loženja sa košticama vo a i to pre svega višnja, trešnja. **Ukoliko korisnik želi da koristi neki oblik biomase koji nije naveden, obavezno treba da kontaktira službu konstrukcije i razvoja Radijator inženjeringa ili ovlaš enog prodavca, jer vrlo esto pojedini oblici biomase zahtevaju posebna, specifi na rešenja sagorevanja.** Prilikom koriš enja navedenih goriva podrazumeva se automatska kontrola glavnih parametara rada. U svim navedenim primerima koriš enja biomase zahteva se odre en stepen suvo e goriva. S' druge strane zahtevi tržišta su uvek okrenuti ka što ve oj univerzalnosti goriva.

Drveni peleti su dobijeni od 100% celuloze. Ostaci drveta pod visokim pritiskom su sabijeni u pelet pre nika 6 mm i dužine 2-3 cm. Pelet treba pravilno skladištiti i to na suvom mestu da bi se obezbedilo efikasno sagorevanje. Kotlovi ECO COMFORT 25 i ECO COMFORT 45 koriste pelet pre nika 6 mm, dužine 5-30 mm i vlažnosti do 10% izra en po standardu **EN 14962-2**.

Seriya kotlova ECO COMFORT proizvodi se u dve varijante snage **ECO COMFORT 25** i **ECO COMFORT 45**. **ECO COMFORT 25** pokriva opseg snaga od 15÷25 kW, a **ECO COMFORT 45** je u opsegu 30÷45 kW.

KONSTRUKCIJA

Po spoljašnjem dizajnu, dimenzijama ložišta, otvorima za loženje i iš enje ECO COMFORT je zadržao sve dobre osobine predhodnih modela po kojima je RADIJATOR INŽENJERING prepoznatljiv na tržištu.

Vodeni deo kotla, njegov na in izmene toplote izme u dimnih gasova i vode, prilago en je biomasi. Zbog primene ventilatora, tj. prinudne promaje put dimnih gasova duži je nego kod standardnih kotlova. Iz istih razloga mogu a je primena usmeriva a dimnih gasova tzv. turbulatora koji dodatno pove avaju stepen iskoriš enja kotla.

Stepen korisnosti na pelet je preko 91%. Pri normalnim režimima temperatura dimnih gasova na izlazu je oko 170°C , a pri maksimalnim režimima je ispod 210°C. Ove vrednosti mogu u svakom trenutku da se o itaju na displeju. Tokom rada dolazi do stvaranja naslaga gareži i pepela na izmenjiva kom delu kotla i to zna ajno uti e na slabiju izmenu i porast temperature dimnih gasova. Ako se kotao ne isti duže vreme mogu je toliki porast temperature dimnih gasova da dolazi do ulaska u modulacijski režim rada. Svaka veli ina ECO COMFORT kotla poseduje bakarni izmenjiva za termi ko osiguranje. Svi delovi vodenog dela kotla izra eni su od bešavnih cevi kvaliteta **ST 35.4** i kotlovskih limova debljine 3 do 5 mm, u zavisnosti od snage kotla. Limovi su kvaliteta **1.0425 EU** standard odnosno **P265GH** standard **EUII**.

Ložište je po svojem principu rada tzv. „izviru e“, gde gorivo iz zone transporta ide vertikalno uvis tj. izvire do zone sagorevanja. Napravljeno je od masivnih izolacijskih materijala i sivog liva.

Transport goriva obezbe en je pužnim transporterima. Gorivo dolazi iz silosa zapremine 240 L. U slu aju potrebe vrlo je lako, demontirati ceo sklop u tri nezavisne celine: silos, mehanizam za nalaganje i kotao.

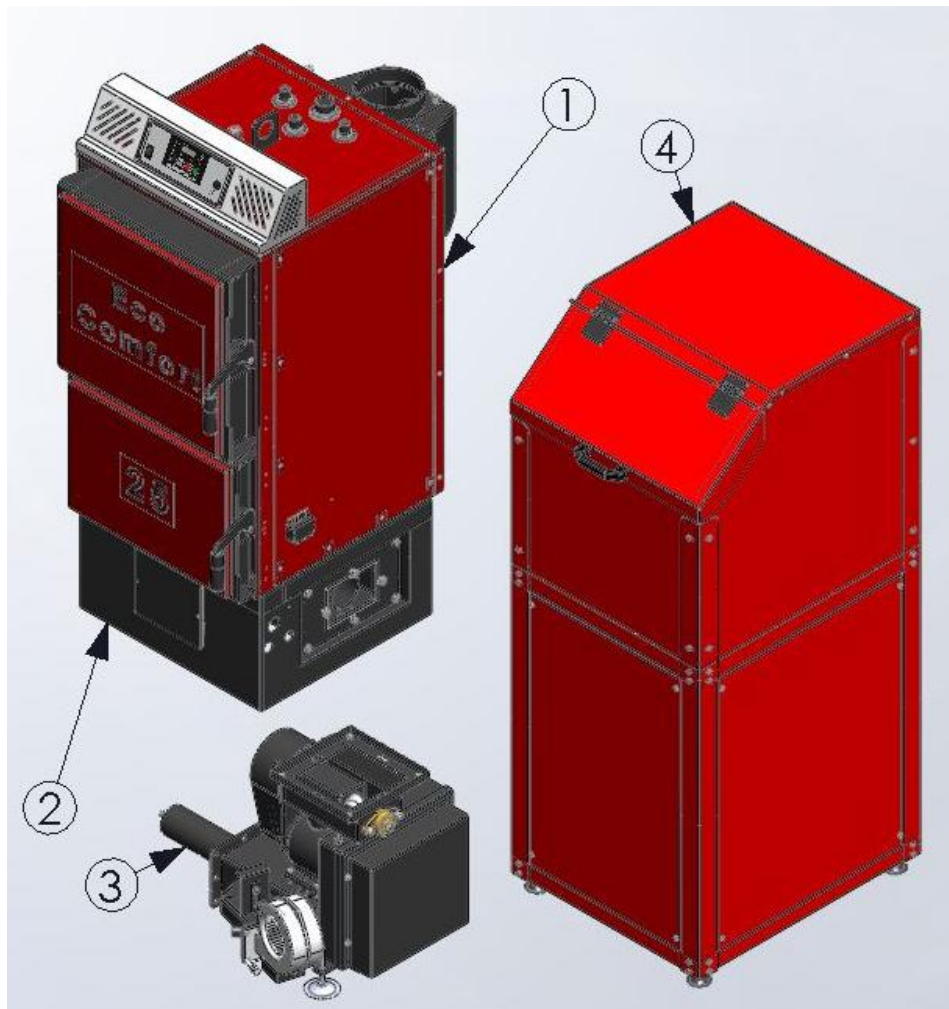

Slika 1. Delovi kotla

Opis:

1. Telo kotla;
2. Ložište;
3. Dozer;
4. Silos;

3. Montaža

3.1 Opšta upozorenja

Kotao mora biti pravilno postavljen zbog pravilnog rada!

Kotao se isporučuje sa spoljnom oblogom koja sadrži izolaciju debljine 30 mm.

Položaj silosa i mehanizma za transport peleta je standardno fabrički desni u odnosu na kotao.

Moguće je naručiti da se u fabrici sklopi i leva varijanta. Takođe, ako je potrebno lako je promenu izvršiti i na terenu jer je silos i ceo mehanizam dozatora demontažan u odnosu na kotao. Elektro priključci su konektorskog tipa tako da za njihovo rastavljanje i ponovno sastavljanje nije potrebno osoblje specijalizovane elektro struke.



Silos i mehanizam za transport za ECO COMFORT 25 i ECO COMFORT 45 imaju fleksibilnu vezu sa mehanizmom za transport, a sve to kako bi se izbegle vibracije tokom rada . (slika 2.)

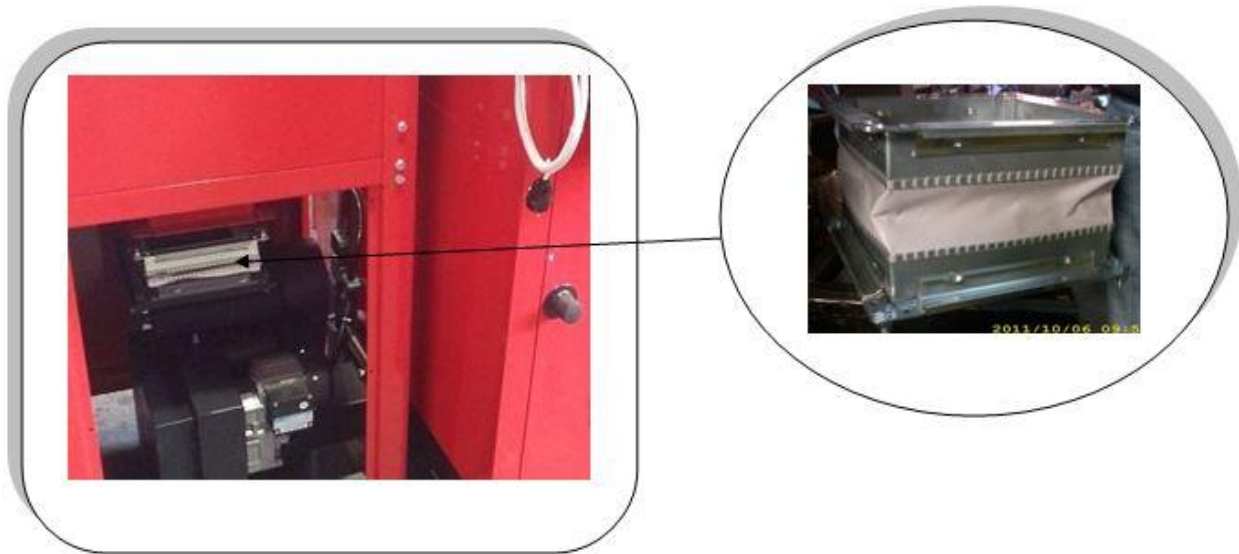

Slika2. Prikaz fleksibilne veze



Maksimalni radni pritisak kotla je 3 bar-a, minimalni 1 bar, a maksimalna radna temperatura kotla je 110° C.



Kotao je sa ventilatorom i automatikom i oba uređaja koriste napajanje 230V, tako da nepravilno instaliranje i neoprezno rukovanje mogu da ugroze ljudski život strujnim udarom.



Kotao na vrsto gorivo i prinudnom promajom treba instalirati prema važe im normama i zakonskim propisima. Svaka izmena ili na mehani koj konstrukciji ili na elektri noj instalaciji smatra e se narušavanjem garancijiskih uslova i doveš e do njenog narušavanja.



Prilikom montaže na hidrauli ku instalaciju kotao mora biti obezbe en na propisan na in od prekora enja maksimalne radne temperature i pritiska.



Za propisnu montažu odgovoran je instalater centralnog grejanja koji priklju uje kotao na hidrauli ki sistem.



Radijator inženjering, kao proizvo a kotla, ne preuzima nikakvu odgovornost za štete prouzrokovane lošim instaliranjem kotla.

Osnovni zahtevi koje treba ispoštovati prilikom montiranja su:

- Kotao može da bude priklju en na otvoreni sistem centralnog grejanja, ali i na zatvoren sistem centralnog grejanja. U slu aju priklju enja na zatvoreni sistem, preporu uje se ugradnja ventila za termi ko osiguranje oticanjem, što je odre eno i odgovaraju im zakonima svake države u kojoj se kotao priklju uje.
- Kotao mora da se nalazi na sigurnoj udaljenosti od lako zapaljivih materijala.
- Elektri no napajanje kotla je 230V i 50Hz i priklju enje svih ure aja koje kotao sadrži treba uraditi prema vase im propisima i priklju enje radi lice sa odgovaraju im ovlaš enjem.
- Priklju enje na dimnjak tako e se radi prema obavezuju im propisima kao i preporukama proizvo a a što se može videti u narednom tekstu.

3.2 Mere i uređaji bezbednosti kod kotlova ECO COMFORT

Za bezbedan rad kotla potrebno je ugraditi i održavati ih ispravnim sledeće elemente:

- Ventil sigurnosti na pritisak (slika 3)



Slika 3.



Slika 4.



Slika 5.

- Ventil sigurnosti na pritisak mora biti nazivnog preseka $1/2$ cola baždaren na maksimalno 3 bara.
- Ovaj sigurnosni element koji spada u grupu limitatora pritiska mora da bude takve konstrukcije da izdrži i kratkotrajna prekoračenja i temperature i pritiska kao i određeni sadržaj glikola u tečnosti za grejanje.
- Obično na istom mestu se priključuju još i odzračak (slika 4.) i manometar (slika 5.) tako da ova tri elementa zajedno sa injavaju sigurnosnu grupu i montiraju se preko „T” priključka.
- Ovaj sigurnosni element mora da podleže i periodičnim ponovnim baždarenjima o čemu investitor tj. korisnik kotla mora da poseduje validnu dokumentaciju.
- Ventil sigurnosti mora biti montiran na najvišoj tački kotla i direktno na kotlu bez bilo kakvog cevovoda ili bilo kojih drugih elemenata između. Za ovu svrhu postoji i posebno predviđeni priključak (videti sliku 7.). Strogo je zabranjeno bilo kakvo reduciranje preseka ovog priključka.
- Ispusni tj. izduvni deo ventila sigurnosti mora da bude od cevi čiji je prečnik najmanje jednak nazivnom preseku ispusnog dela ventila. Takođe je dozvoljeno je za njegovu izradu koristiti najviše jedan luk radijusa $r > 3d$.
- Sigurnosni ventil mora posedovati nazivnu pločicu i na njoj sledeće podatke:
 - - naziv proizvođača
 - - oznaka tipa sigurnosnog ventila/godina ispitivanja
 - - nazivni protok
 - - podatak za koji toplotni učinak je sigurnosni ventil podešen
 - - najviši pritisak otvaranja tj. 3 bara
- Obavezna je provera ispravnosti rada u određenim vremenskim periodima kao i ponovna baždarenja od strane sertifikovanih firmi. Ove obaveze se sprovode u skladu sa zakonom svake zemlje u kojoj je kotao namontiran. Obavezno čuvati pisani dokument o podacima zadnjeg baždarenja sigurnosnog ventila.
- Na povratnom vodu montirati barem još jedan ventil sigurnosti na pritisak.

-Ventil termi kog osiguranja oticanjem (slika 6)



Slika 6.

Ovaj sigurnosni element ima tako e ulogu ograni iva a temperature. U daljem tekstu bi e ozna en sa skra enicom VTO.

- U nekim ekstremno opasnim situacijama prelaz vode u vodenu paru je takav da ventili sigurnosti za pritisak nisu dovoljni da obezbede sigurnost hidrauli kog sistema. Iz ovog razloga je obavezna ugradnja VTO. U zavisnosti od zakonskih regulativa zemalja u kojima se kotao montira, VTO je potrebno ugraditi samo za snage ve e od odre enih ili za svaku snagu kotla obavezno ugraditi VTO.
- Mesto ugradnje prikazano je na šemi montaže kotla na instalaciju i na **slici 7**.
- U kotlu se isporu uje bakarna spirala tako da je potrebno koristiti VTO sa izmenjiva em kao na **slici 7**. Do VTO-a se dovodi hladna sanitarna voda. Kada sonda VTO-a ima informaciju da je temp. preko 95 stepeni VTO se otvara i voda prolazi kroz bakarnu spiralu. Posle izvesnog vremena temp. vode u kotlu se vra a na normalnu.
- Jedan priklju ak spirale koristimo za VTO a drugi za ispust vode koja je prošla kroz spiralu. Koji je priklju ak spirale za VTO a koji je ispusni je nebitno. Obavezno je pridržavati se uputstava ugradnje koje je dao proizvo a VTO.
- Obavezno u odre enim vremenskim periodima proveravati funkciju VTO.

Kao što je ve re eno jedan kraj VTO je za montažu na izmenjiva kotla a do drugog se dovodi hladna voda pod pritiskom. Naro ito je bitno da protok te vode bude neometan i pri nestanku el. energije.



Ukoliko je nemogu e obezbediti dotok hladne sanitarne vode i pri nestanku el.energije,obavezno kotao priklju iti na otvoren sistem.

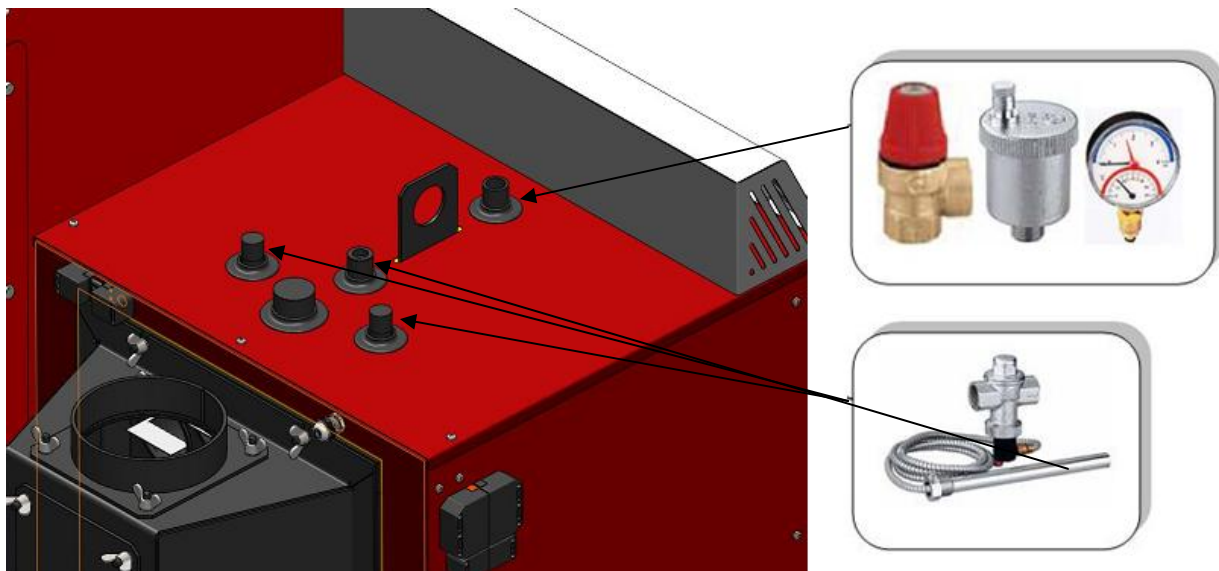

Slika 7. Prikaz postavljanja sigurnosnih elemenata

Termostati u automatici kotla

- U samoj automatici koja vodi proces sagorevanja i utiče na rad kotla i sistem centralnog grejanja postoje dva ugrađena termostata. Ovi termostati dobijaju informacije o temperaturi vode i dimnih gasova preko temperaturnih sondi. Ovi termostati su prvenstveno namenjeni za pravilan rad kotla mada imaju i sigurnosne funkcije ali ne spadaju u grupu sigurnosnih elemenata.

Kao sigurnosni element koristi se termostat kao na slici 8 i on ima funkciju ograničavanja temperature vode u kotlu, i on je nezavisna komponenta. Temperatura je ograničena na 95 stepeni Celzijusa. STB termostat je fizički lociran pored displeja automatike ali je strujno vezan sa njom.



Montaža slavine za punjenje i pražnjenje se vrši u najmanjoj tački sistema, na samom kotlu postoji priključak za punjenje i pražnjenje, ili slavinu priključiti u najnižju tačku povratnog voda. Instalaciju puniti polako kako bi se sistem dobro odzračio. Nakon punjenja instalacije proveriti da nema curenja u sistemu centralnog grejanja.

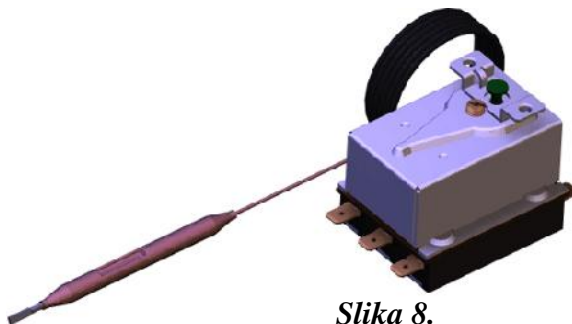

Slika 8.

Radijator Inženjering d.o.o, 36000 Kraljevo, Živojina Lazića - Solunca br.6, Srbija
tel. +381 36 399 140, fax. +381 36 399 150, <http://www.radijator.rs>
e-mail: radijator@radijator.rs

3.3 Kotlarnica

Kotlarnica mora biti obezbeđena od smrzavanja.

Podloga za kotao u kotlarnici mora biti od nezapaljivog materijala. Preporučene vrednosti udaljenosti sve četiri strane kotla u odnosu na zidove kotlarnice ili neka druga kruta tela (akumulacioni bojler itd.) prikazane su na *slici 9*. Ove vrednosti udaljenosti omogućavaju siguran pristup prilikom loženja, dovoljan prostor za održavanje i nesmetan pristup ventilatoru i ventilu za punjenje i pražnjenje. Kotao sa svoje leve strane treba da bude udaljen od zida 200 mm tj. onoliko koliko je potrebno prostora za priključenje ventila za termičko osiguranje oticanjem. Ako se ventil ne ugrađuje onda prostor može da bude i manji.

Kotlarnica mora da poseduje dovoljne otvore za ventilaciju kako za svež vazduh tako i za odvođenje istrošenog vazduha!

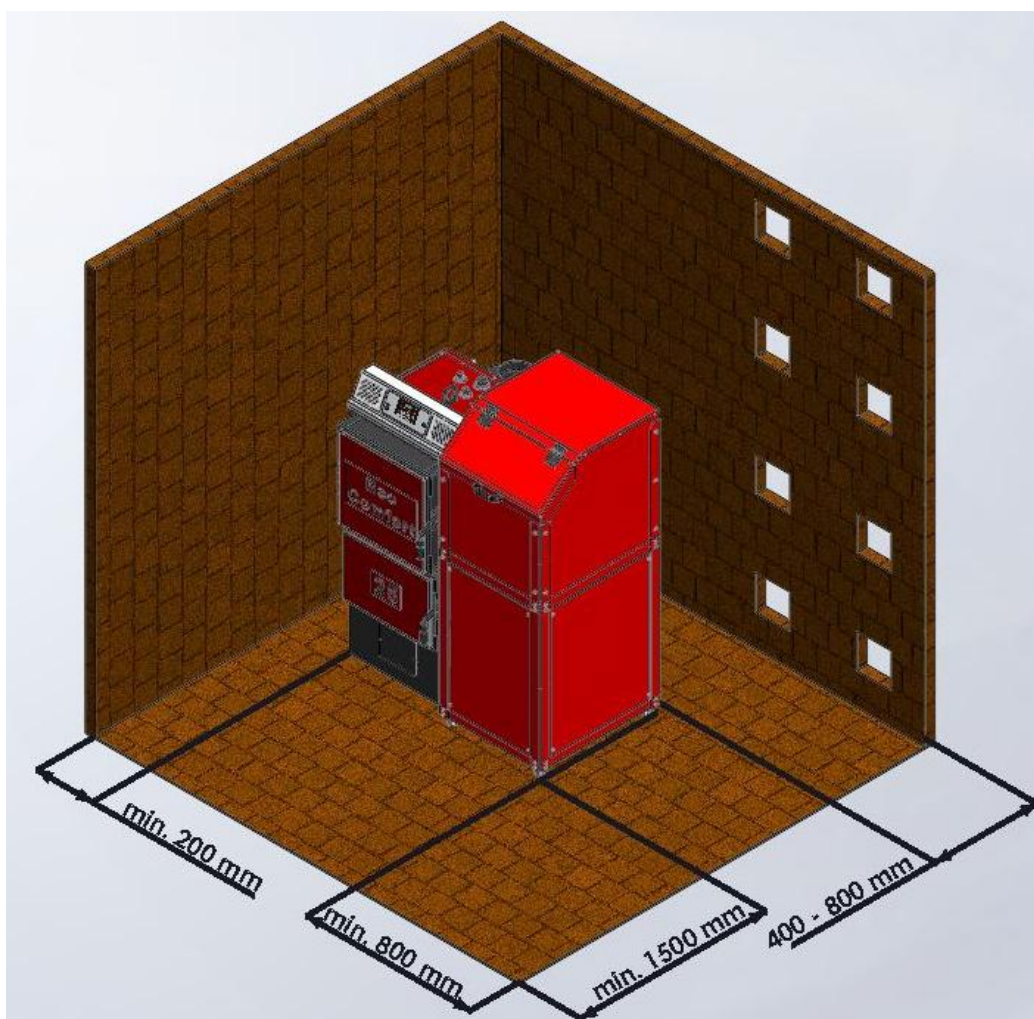

Slika 9. Pozicioniranje kotla u kotlarnici

Ukupna površina ovih otvora je minimalno 150cm² za snage do 50kW a za snagu preko 50kW površina mora biti veća a za još 2cm² po kilovatu.

$$A = 150\text{cm}^2 + \frac{2\text{cm}^2}{\text{kW}} \times (\sum Q_n - 50\text{kW}) \quad \sum Q_n = \text{moguće snage preko 50kW.}$$

Nedostatak dovoljne ventilacije u kotlarnici može da uzrokuje više problema u radu kotla. Glavni problem je nemogućnost postizanja visokih temperature izlazne vode tj. ne postizanje maksimalne snage što dovodi do kondenzovanja u kotlu.

- Uzeti u obzir neophodan minimalni prostor koji je potreban za prilaz sigurnosnim elementima i za izvršenje operacija ispuštanja.
- Utvrditi da li je stepen električne zaštite u skladu sa karakteristikama prostorije u kojoj će kotao biti smešten.
- Zabranjeno je izlaganje kotla atmosferskim nepravilnostima. Sam kotao nije predviđen za spoljnu montažu i ne sadrži sistem protiv smrzavanja.
- Zabranjeno je zatvaranje ventilacionih otvora na prostoriji u kojoj se nalazi kotao. Ventilacioni otvori su neophodni za pravilno sagorevanje.

3.4 Priklu enje na dimnjak

Kotao ECO COMFORT radi sa prinudnom promajom, ali ipak treba ispoštovati pravila za odabir dimnjaka kao da se radi o kotlu sa natpritiskom u ložištu na neko drugo gorivo, kao na lož ulje na primer.

U suprotnom može do i do problema u radu, naro ito u fazi potpale.

Preporuka je da pre nik dimnjaka bude barem jednak pre niku dimnja e kotla a minimalna visina 7 do 8 metara, sve u zavisnosti od pokrivenosti dimnjaka nekim drugim visokim gra evinama pored njega.

Najoptimalnije postavljanje kotla na dimnja u je takvo da prava koja spaja centar izlaza dimnih gasova iz kotla i centar priklju enja na dimnjak bude u blagom usponu (do 3%)

(pogledati **sliku 10a** i **sliku 10b**).

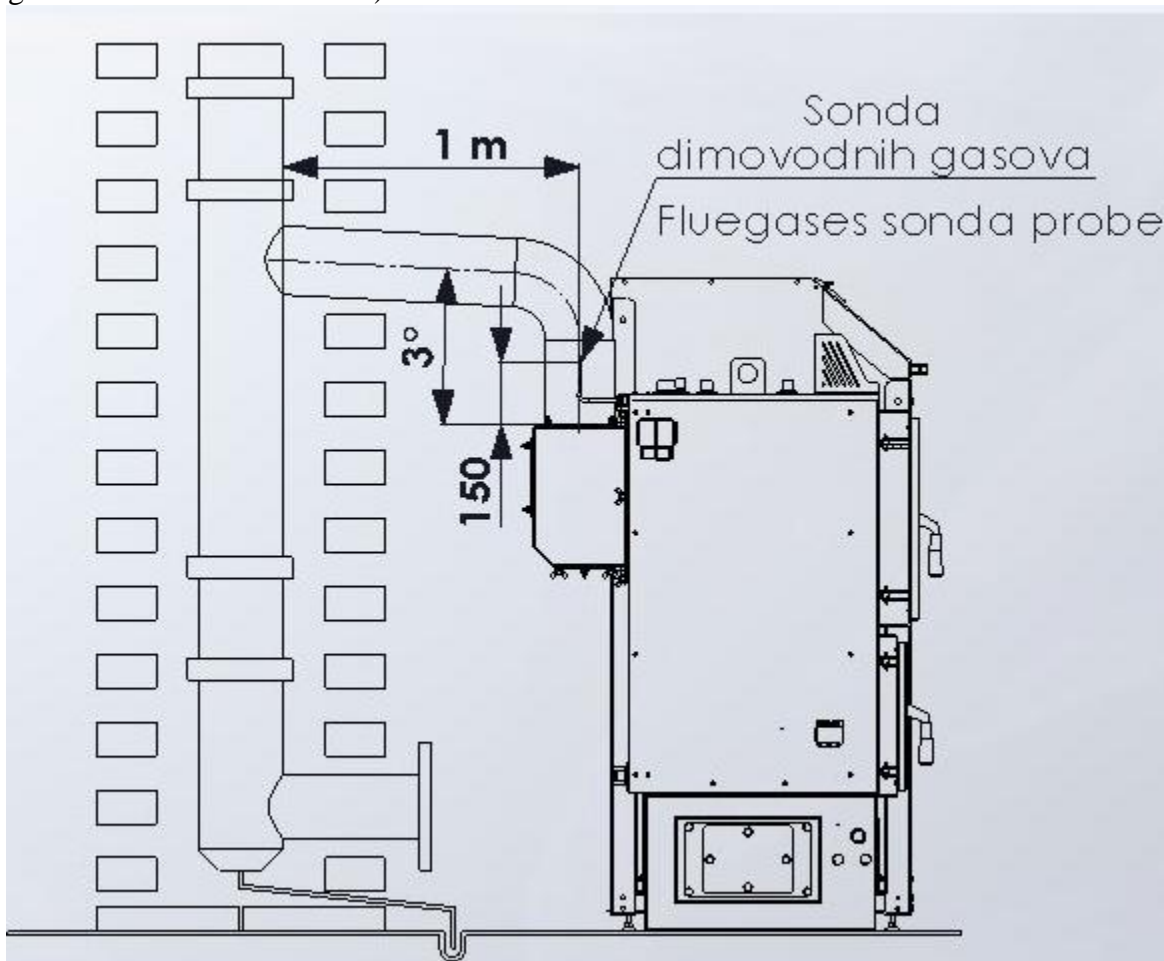

Slika 10a. Prikaz priklju enja na dimnjak

Treba izbegavati ako je mogu e lukove, a ako nije onda je maksimalni broj lukova (2). Dimni kanal od kotla do dimnjaka poželjno je izolovati, posebno ako ima lukova i dužih deonica.

Na dimnoj cevi, približno 150 mm od dimnja e kotla, treba izbušiti otvor i montirati uložak za temperaturnu sondu dimnih gasova. Bez informacije o temperaturi dimnih gasova nema ni automatskog režima rada kotla.

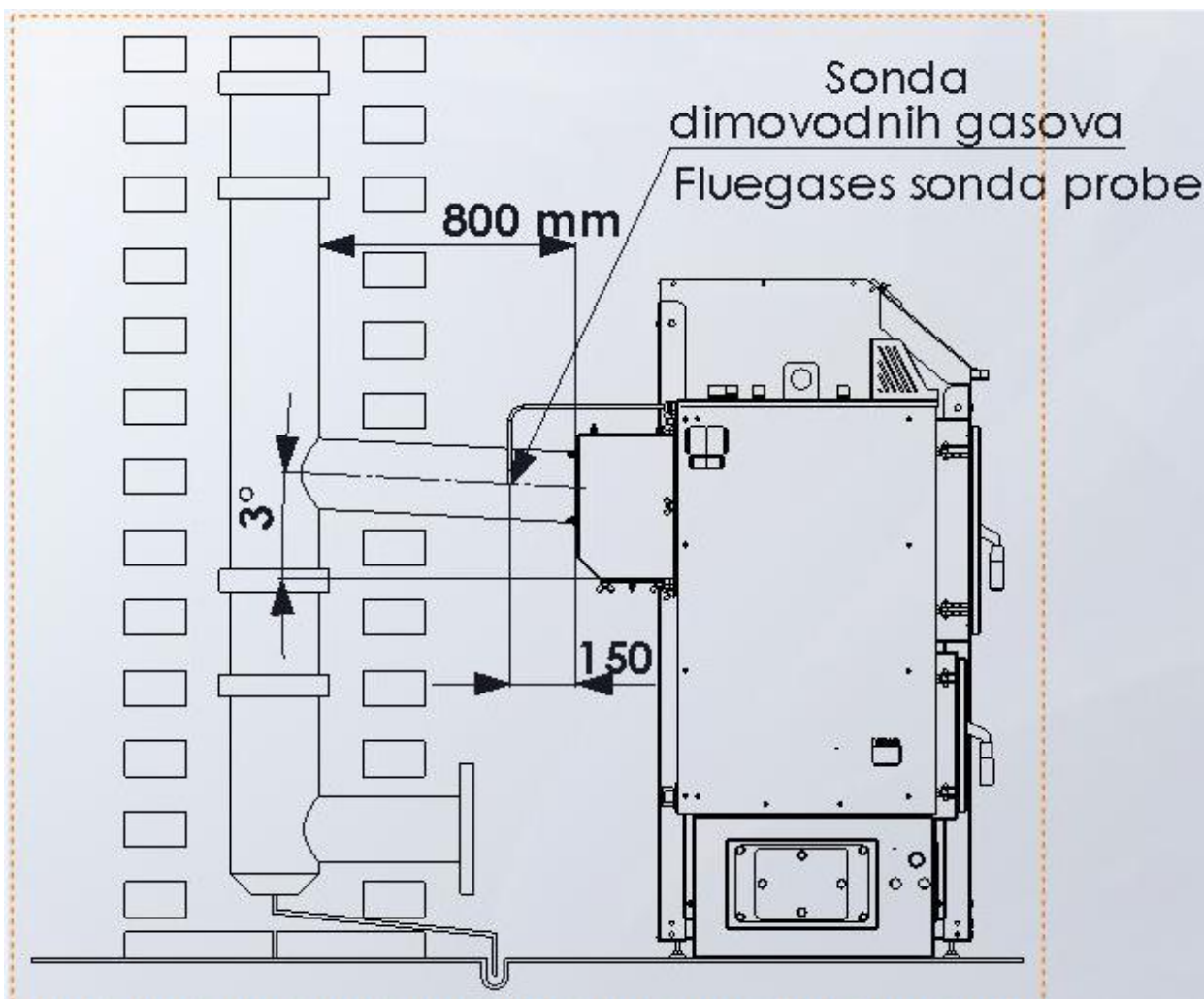

Slika 10b. Prikaz priklju enja na dimnjak

Sam dimnjak treba da je napravljen od kerami kih cevi, oko njih treba da je izolacija debljine 3-5cm i zadnji spoljni sloj je cigla ili specijalni dimnja ki elementi. Ako dimnjak ipak nije od keramike ve od cigle, površina svetlog preseka takvog dimnjaka mora da bude 30% ve a nego ovakva površina kerami kog dimnjaka.

Dimnjak mora da ima i vratanca za iš enje a ona moraju dobro da dihtuju. Izlaz dimnjaka na krovu mora da bude po odre enim propisima. Razlikuju se dva slu aja: ako je ugao krova manji od 12° i ako je ugao krova veci od 12° . Za ugao manji od 12° visine dimnjaka iznad krova je 1m a za ugao veci od 12° treba pogledati skicu.

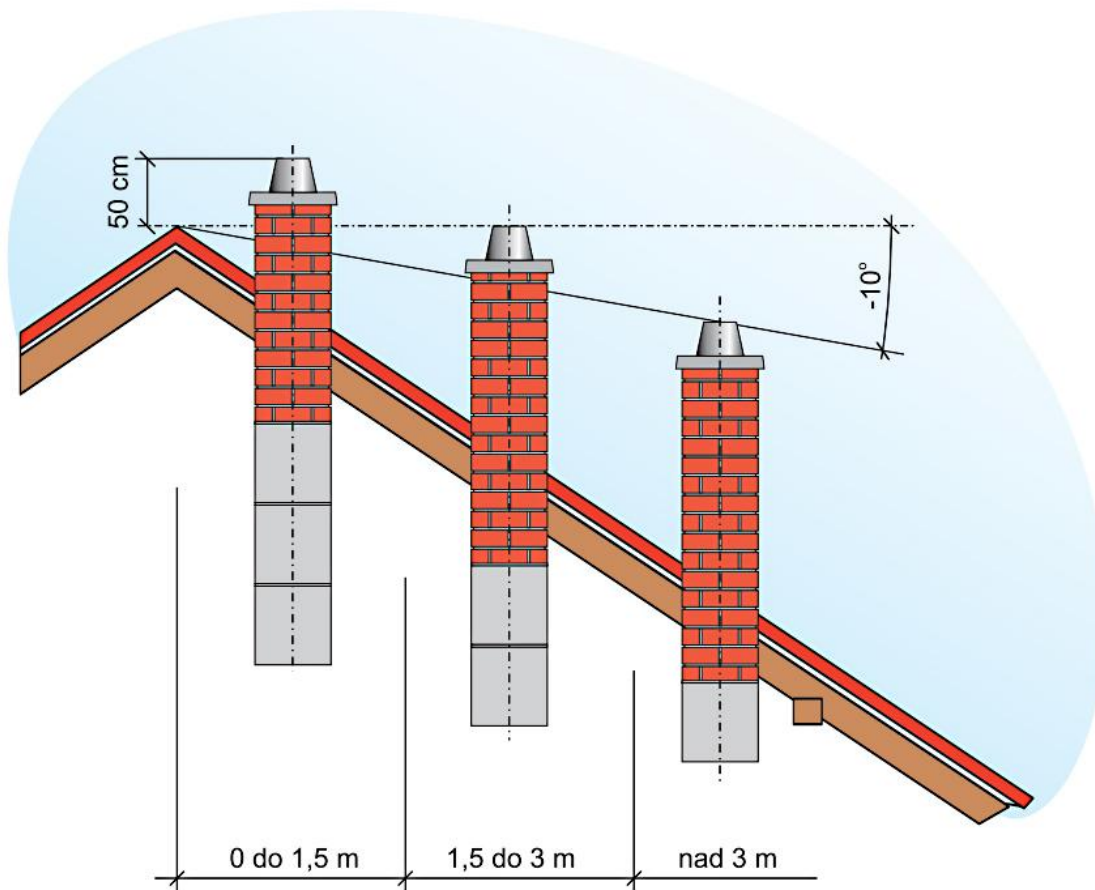

Ukoliko mislite da je dimnjak prejak i da isuviše hladnog vazduha prolazi kroz kotao, potrebno je ugraditi klapnu kako bi se smanjio protok izduvnih gasova.

Dimnjak treba redovno da se isti ili barem jedanput godišnje.



Ukoliko dimnjak nije propisne visine, poprečnog preseka ili ako se ne mogu postaviti na odgovarajućem mjestu, moguće su komplikacije u radu kotla. Pre svega nije moguće visokotemperaturni režim rada, tj. nema maksimalne radne snage, a posledice toga je pojava kondenzacije što utiče na radni vek kotla.



Slab dimnjak je glavni razlog da u toku potpale kotla ili u toku rada imamo pojavu dima na gornjim ili donjim vratima, naročito pri većim brojevima obrtaja ventilatora.

4. Presek ECO COMFORT 25 kotla sa opisom elemenata

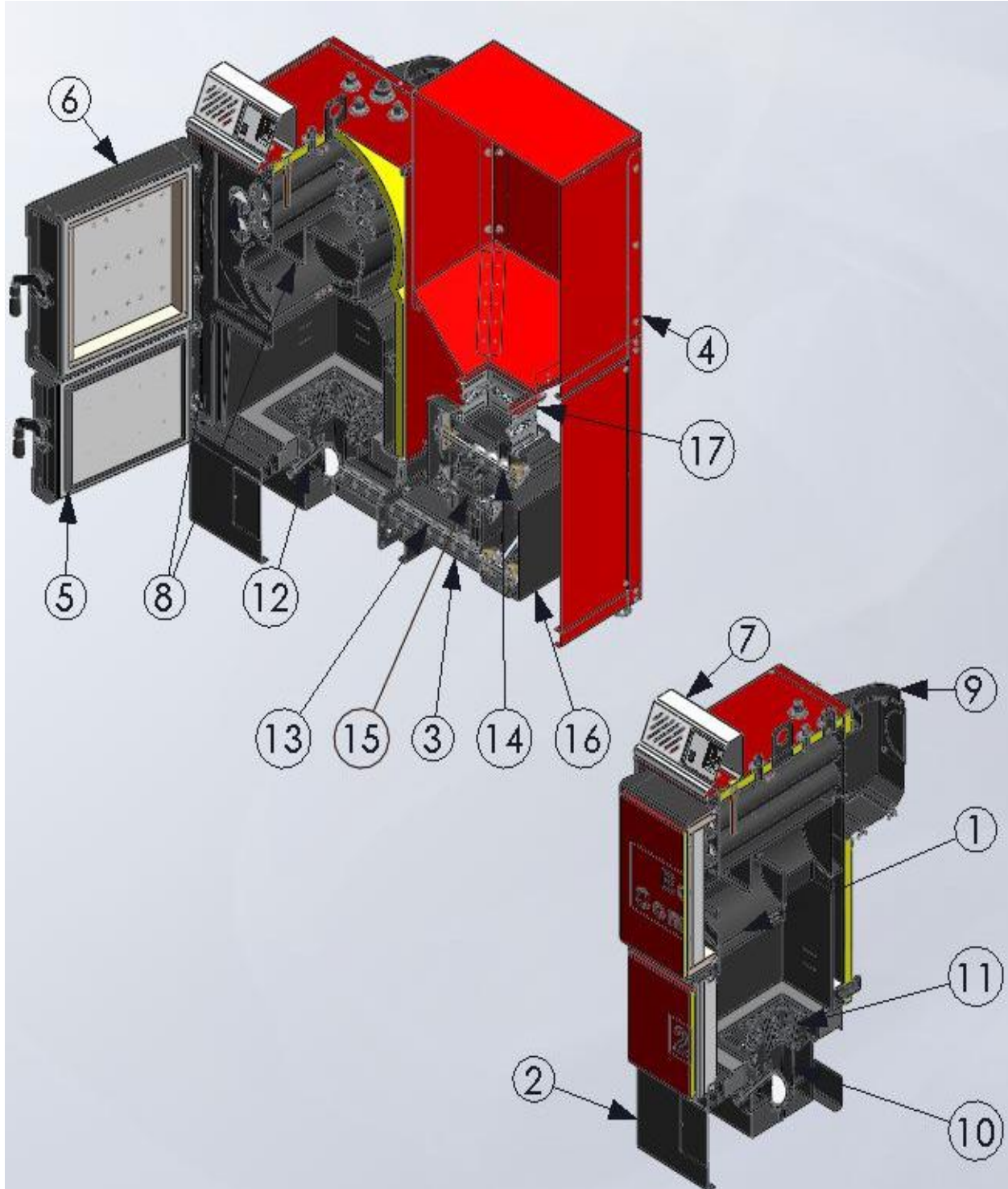

Slika 11. Presek kotla ECO COMFORT 25

Radijator Inženjering d.o.o, 36000 Kraljevo, Živojina Lazića - Solunca br.6, Srbija
tel. +381 36 399 140, fax. +381 36 399 150, <http://www.radijator.rs>
e-mail: radijator@radijator.rs

Opis:

1. Telo kotla;
2. Ložište;
3. Dozer;
4. Silos;
5. Donja vrata za potpalu i iš enje;
6. Gornja vrata za iš enje;
7. Automatika;
8. Turbulatori;
9. Dimnja a;
10. Ložište za pelet;
11. Liveni segmenti;
12. Greja ;
13. Donji pužni transporter;
14. Gornji pužni transporter;
15. Rotacioni sigurnosni element;



16. Kutija sa ležajevima i lan anicima;
17. Fleksibilna veza.

5. Šema povezivanja automatike

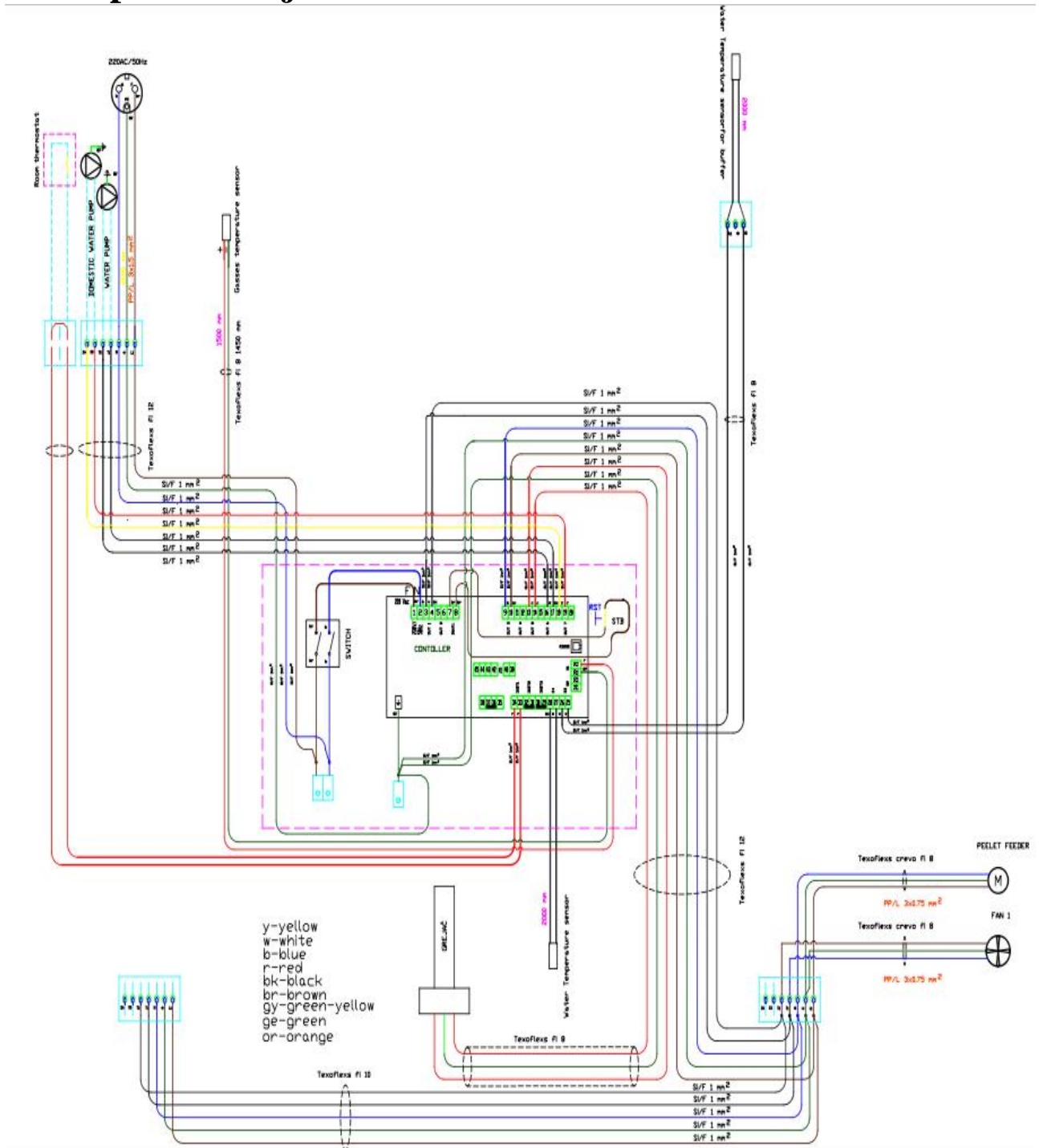

Sve linije koje su prikazane isprekidano na šemi spoljnih priklju enja su provodnici koje je potrebno da instalira tehni ko lice prilikom priklju enja spoljnih ure aja na automatiku kotla. Sva priklju enja dodatnih ure aja tehni ko lice obavlja preko dva konektora koja se nalaze na zadnjem delu kotla. Jedan konektor je trolepolni a jedan je sedmopolni. Trolepolni je za priklju enje sobnog termostata što je prikazano na nalepnici samog konektora.

 ***Za sobne termostate bitno je da budu sa baterijskim napajanjem tj. da nemaju na sebi bilo kakav dovod napona 220 V. Na samom termostatu za povezivanje se koristi NC (normalno zatvoreni kontakt).***

Sedmopolni konektor je za priklju eni mrežni kabal i za priklju enje cirkulacione pumpe i pumpe akumulatora odnosno bojlera za sanitarnu vodu.

 ***Kotao može da radi i u slu aju da nije priklju ena pumpa za *centralno grejanje*, ali preporuka proizvo a a je da se ona ipak priklju uje jer ima *funkciju sigurnosnog elementa*. Uklju uje se kada temperatura vode u kotlu preraste 90°C.***

6. Tabela sa tehni kim podacima

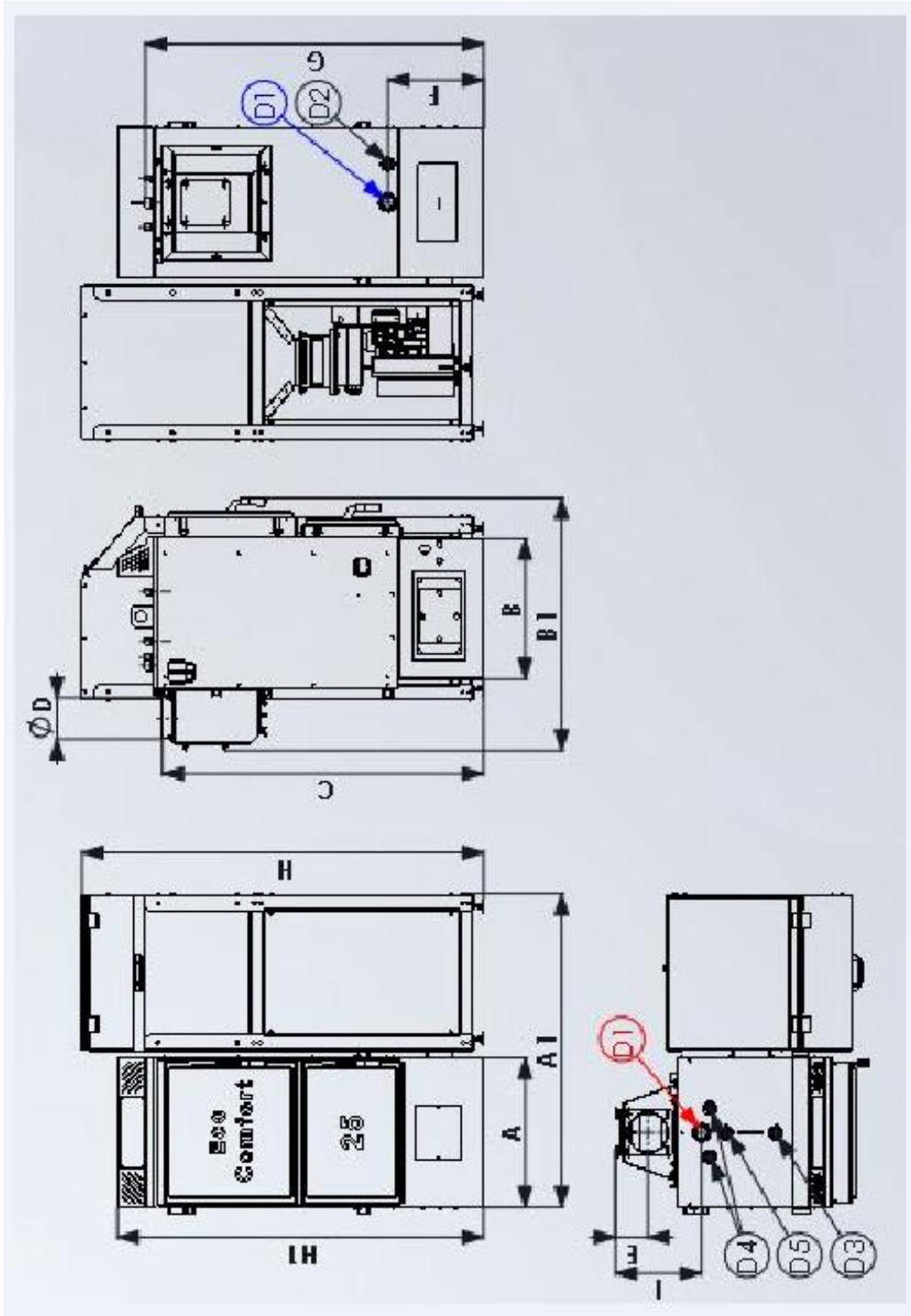

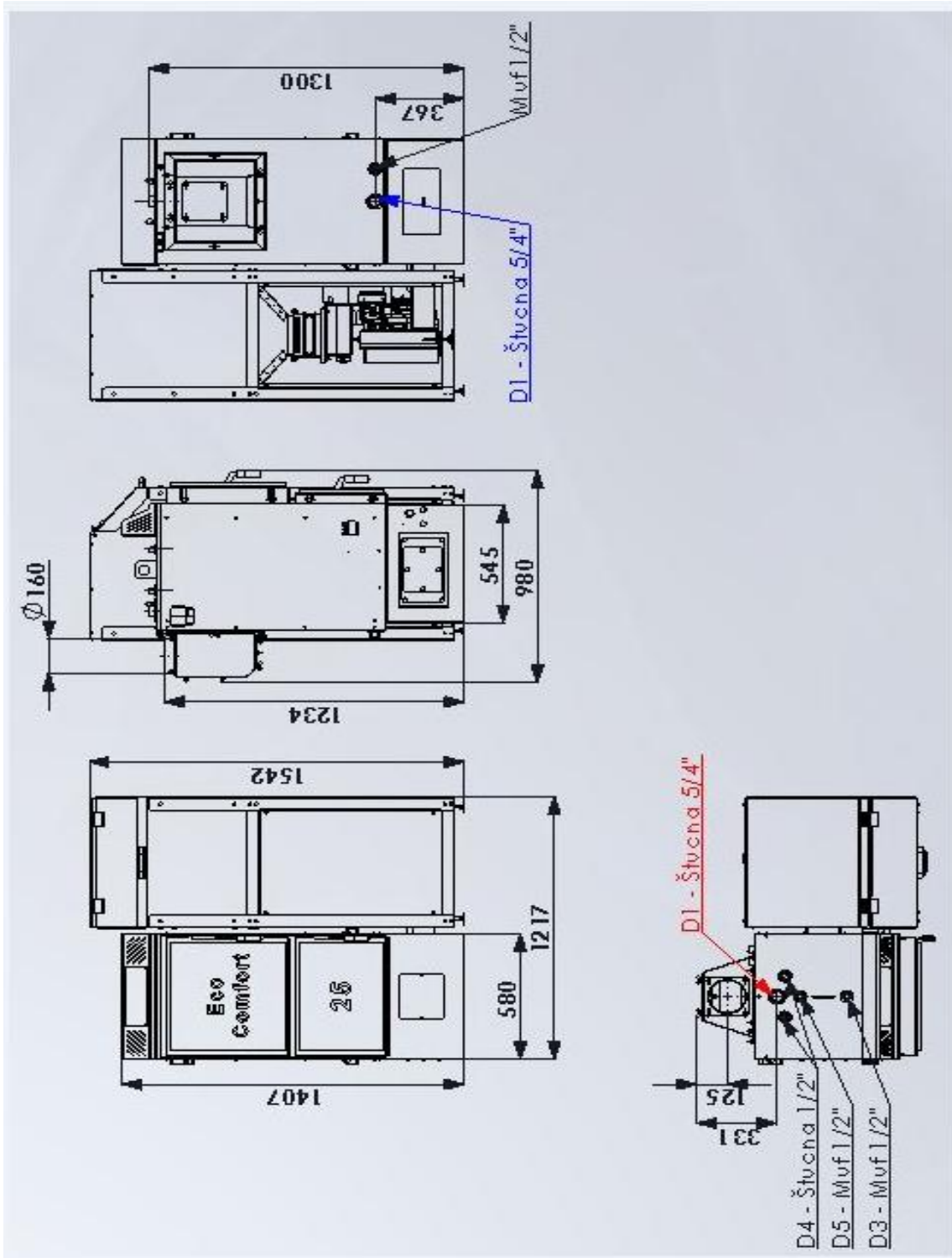

TIP KOTLA		Eco Comfort 25
CE oznaka		CE
Klasa kotla po EN 303-5:2012		5
Radni pritisak	bar	3
Probni pritisak	bar	4,5
Zapremina ložišta	L	68
Zapremina vode u kotlu	L	85
Masa	kg	428
Popre ni presek dimnjaka	mm	160
Potrebna promaja dimnjaka	mbar/Pa	0,15/15
Temperatura kotla (min/max)	°C	60/90
Minimalna temperatura povratnog voda	°C	60
Stepen iskoriš enja (nominalna/minimalna toplotna snaga kotla)	%	91,96/92,63
Nominalna snaga	(kW)	25,26
Minimalna/Maksimalna snaga kotla	(kW)	7,41-25,26
Emisija ugljen monoksida (Co) pri minimalnoj toplotnoj snazi (10%O2)	(mg/m3)	89,69
Emisija ugljen monoksida (Co) pri nominalnoj toplotnoj snazi (10%O2)	(mg/m3)	156,38
Prašina (nominalna/minimalna toplotna snaga) (10%O2)	(mg/m3)	18,01/ 19,14

Dimenzije		
	A	580
	A1	1217
	B	545
	B1	980
	C	1234
	D	160
	E	125
	F	367
	G	1300
	H	1542
	I	231
Priklju ci za toplu i hladnu vodu	D1	5/4"
Priklju ak za punjenje i pražnjenje kotla	D2	1/2"
Priklju ak za odzra ivanje i ventil sigurnosti na pritisak	D3	1/2"
Priklju ci za ventil termi kog osiguranja oticanjem VTO	D4	1/2"
Priklju ak za sondu VTO	D5	1/2"

7. Hidrauli na šema

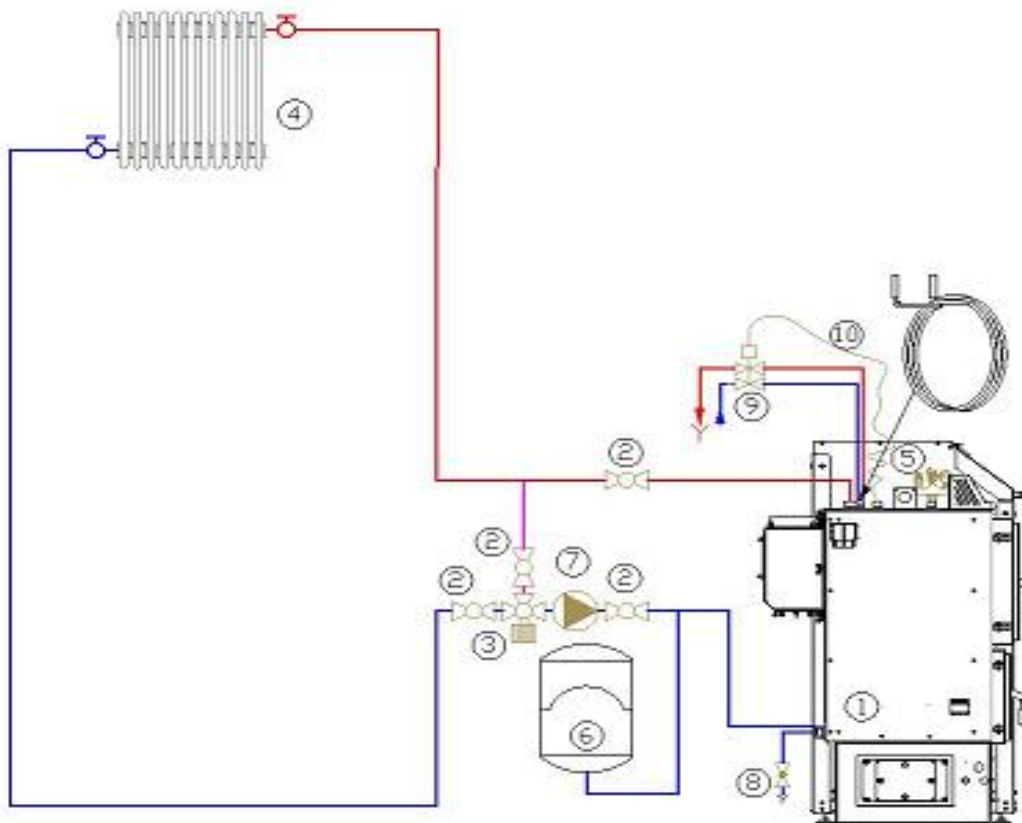

Hidrauli na šema

Opis:

1. Kotao ECO COMFORT;
2. Ventil;
3. Mešni ventil;
4. Izmenjiva ;
5. Sigurnosna grupa;
6. Ekspanziona posuda;
7. Pumpa;
8. Ventil za punjenje/praznjenje;
9. Ventil termi kog osiguranja;
10. Sonda ventila termi kog osiguranja.



Prilikom montaže na hidrauli ku instalaciju kotao mora biti obezbe en na propisan na in od prekora enja maksimalne radne temperature i pritiska.

 Za propisnu montažu odgovoran je instalater centralnog grejanja koji priključuje kotao na hidraulički sistem.

 *Radijator inženjering*, kao proizvođač kotla, ne preuzima nikakvu odgovornost za štete prouzrokovane lošim instaliranjem kotla.

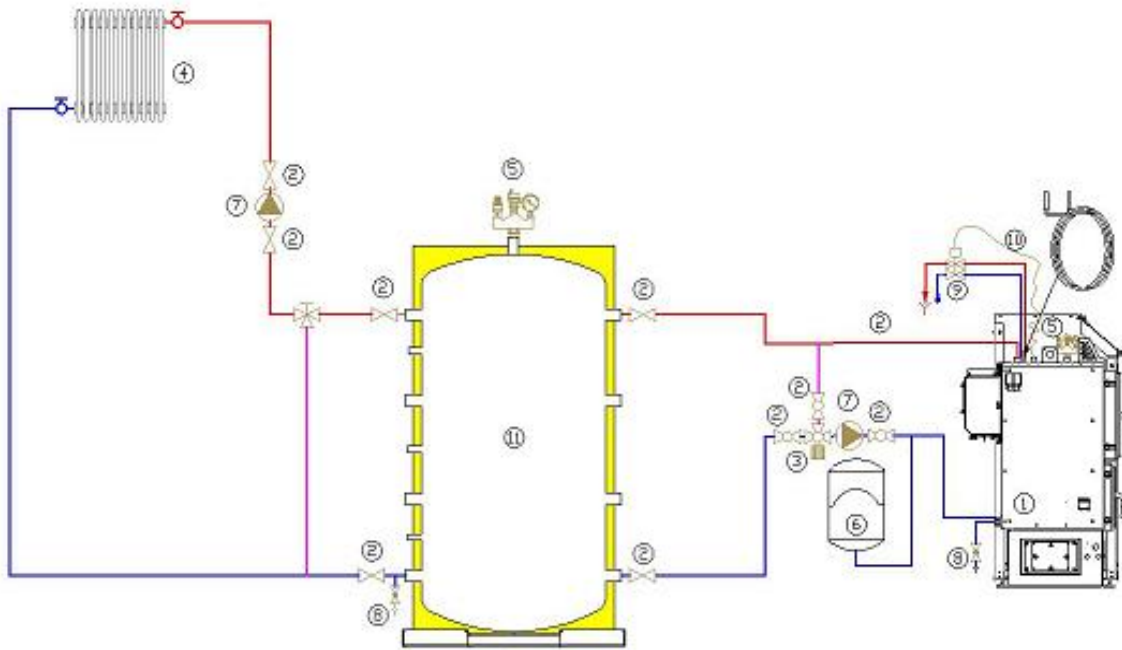

Hidraulička šema sa akumulatorom

Opis:

1. Kotao ECO COMFORT;
2. Ventil;
3. Mešni ventil;
4. Izmenjiva ;
5. Sigurnosna grupa;
6. Ekspanziona posuda;
7. Pumpa;
8. Ventil za punjenje/praznjenje;
9. Ventil termičkog osiguranja;
10. Sonda ventila za termičko osiguranje;
11. Akumulator.

8. Start rada kotla i iš enje



Prvo puštanje kotla u rad obavlja tehni ko lice koje ima sertifikat izdat od strane Radijator inženjeringa. Obavezna je obuka korisnika kotla.

Na taj na in to lice je ovlaš eno da prijavi servisnoj službi u samoj fabrici vreme kada je kotao po eo da radi i u kakvom je stanju kotao bio prilikom prvog paljenja, dok kopiju izveštaja o puštanju kotla u rad zadržava. *Garancija i upustvo za upotrebu se daje kupcu. Jedan primerak garancije se šalje proizvo a u.*

Ako garancija nije ispunjena, ona nije važe a.

Samo kotlovi koji su pušteni u rad od strane ovlaš enog tehni kog lica podležu uslovima kompletne garancije od *dve godine.*

Naredni tekst je namenjen samom korisniku kotla, kao jedna vrsta podsetnika, da ako ugasi kotao (npr. zbog iš enja) bude u stanju da samostalno pokrene kotao.



Parametri vezani za rad kotla a koji su dostupni korisniku su na samom displeju. Ostale parametre koji su u tzv. skrivenom meniju ne treba menjati bez saglasnosti tehni kog lica koje je pustilo kotao u rad ili same fabrike.

8.1 Displej automatike



Komandni panel sa injavaju:

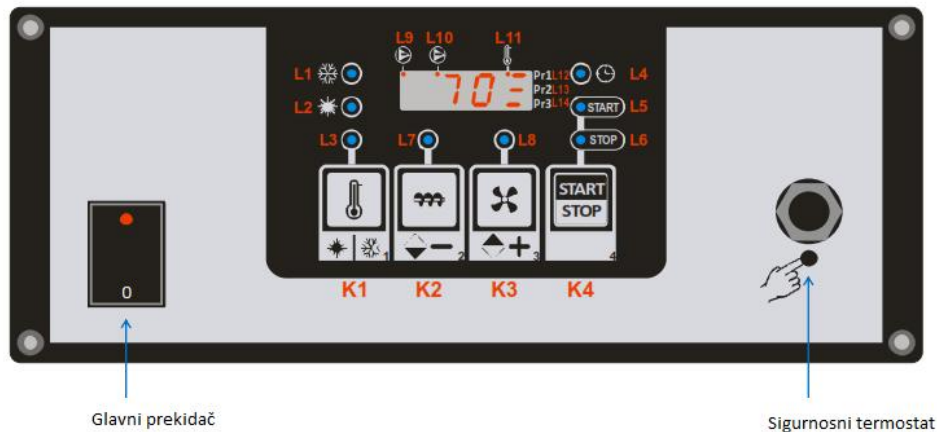

Glavni prekidač, dugme sigurnosnog termostata, displej, grupa komandnih tastera (dugmi a), grupa svetlosnih dioda pokazivača.

Sledeća slika je prikaz kontrolnog panela.

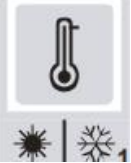

8.1.1 Komandni tasteri

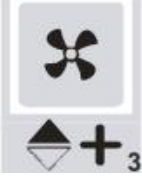







Komandni tasteri	Funkcija
	<p>K1</p> <ul style="list-style-type: none"> • Pritiskom na taster K1 moguće je promeniti zadatu temperaturu vode u kotlu. Pri tome se svetleća dioda L3 uključuje. Promena vrednosti se vrši pomoću tastera K2(-) i K3(+). • Ako taster K1 držimo neprekidno možemo izabrati zimski odnosno letnji režim rada. Pri tome se svetleća dioda L1, odnosno L2 uključuje. • Pritiskom na taster K1 potvrđuje se birana vrednost.
	<p>K2</p> <ul style="list-style-type: none"> • Pritiskom na taster K2 moguće je promeniti radno vreme puža. Pri tome se svetleća dioda L7 uključuje. Promena vrednosti se vrši pomoću tastera K2(-) i K3(+). • Kada se taster K2 drži neprekidno, u režimu ISKLJUČEN (OFF), uključuje se ručno punjenje ložišta peletom. Tokom ove radnje na displeju će biti prikazan natpis "LoAd". Ručno punjenje ložišta peletom se završava kada pustite ovaj taster. Zbog sigurnosti, punjenje ložišta peletom počinje nakon tajmera T72. • Pritiskom na taster K2 smanjuje se izabrana vrednost, a takođe se vrši i listanje parametara.

	<p>K3</p> <ul style="list-style-type: none"> • Pritiskom na taster K3 moguće je promeniti brzinu ventilatora. Pri tome se svetleća dioda L8 uključuje. Promena vrednosti se vrši pomoću tastera K2(-) i K3(+). • Kada se taster K3 drži neprekidno, u režimu ISKLJU EN (OFF), ventilator radi sa maksimalnom brzinom. Tokom ove radnje na displeju može biti prikazan natpis "UEnt". • Pritiskom na taster K3 povećava se izabrana vrednost, a takođe se vrši i listanje parametara.
	<p>K4</p> <ul style="list-style-type: none"> • Kada se taster K4 drži neprekidno, kotao se uključuje/ isključuje. Pri tome se svetleća dioda L5/L6 uključuje. • Prilikom odabira vrednosti tasterima K2 i K3, pritiskom tastera K4 se resetuje odabrana vrednost.
<p>K2+K3</p>	<p>K2+K3</p> <p>Kada se tasteri K2 i K3 drže neprekidno, vrši se promena recepta. Pri tome se svetleće diode L12-L14 uključuju. Moguće je vršiti promenu receptata Pr1/Pr2/Pr3. Broj mogućih receptata je određen parametrom P89.</p>

NAPOMENA:

U režimu **Isklju en (OFF)** možete resetovati prikaz alarma pritiskom na tastere **K2** ili **K3**, ali ako je uzrok alarma i dalje prisutan alarm će se ponovo uključiti.

8.1.2 Svetleće diode

Svetleće diode		Funkcija
	L1	Uključena u zimskom režimu rada.
	L2	Uključena u letnjem režimu rada.
	L3	Uključena kada je temperatura vode u kotlu manja od A03-A05 . Treperi kada je temperatura vode u kotlu iznad zadate. Isključena kada je temperatura vode u kotlu veća od A03 .
	L4	Uključena kada je ulaz Chrono zatvoren.
START	L5	Uključena kada je kotao u režimu UKLJU EN .
STOP	L6	Uključena kada je kotao u režimu ISKLJU EN .
	L7	Uključena kada puž radi.
	L8	Uključena kada ventilator za sagorevanje radi.
	L9	Uključena kada pumpa P1 radi. Treperi kada se pumpa isključuje.
	L10	Uključena ako je ventil/ pumpa P2 uključena.
	L11	Uključena ako je zatvoren kontakt sobnog termostata.
Pr1	L12	Uključena kada je izabran recept 1.
Pr2	L13	Uključena kada je izabran recept 2.
Pr3	L14	Uključena kada je izabran recept 3.

8.1.3 Displej

Displej\Temperatura\Režim\Alarmi: etrvorocifreni/slovni displej prikazuje temperaturu vode u kotlu, radni režim i eventualne alarme

Prikaz	Opis	Prikaz	Opis
OFF	Isklju en (OFF)	Mod	Modulacija
Chc	Provera	MAn	Mirovanje
Acc	Paljenje	Sic	Sigurnosni režim
Stb	Stabilizacija	SPE	Gašenje
rEc	Ponovno paljenje	ALt	Isklju en sistem sa Alarmima

Prikaz	Opis	Prikaz	Opis
tSic	Otvoren je priklju ak sigurnosnog termostata – tastera za ru no resetovanje	PELL	Nedostatak peleta
CALd	Temperatura vode u kotlu je iznad zadate		
AccF	Ne uspelo paljenje		
SPAc	Slu ajno gašenje		
Sond	O itavanje sonde van opsega		

NAPOMENA:

- Uklju ivanjem putem glavnog prekida a, kod proizvoda i verzija programa su prikazane na displeju u trajanju od 2 sekunde.

Displej	Opis
St 14	Kod proizvoda
Ur 1.0	Verzija programa

8.2 Start rada kotla na biomasu

- Koto priklju en na hidrauli ki sistem.
- Izbušiti otvor pre nika 4 mm na gornjoj strani dimne cevi u zoni koja je veoma blizu dimnog izlaza kotla. (slika 12a. i slika 12b.)

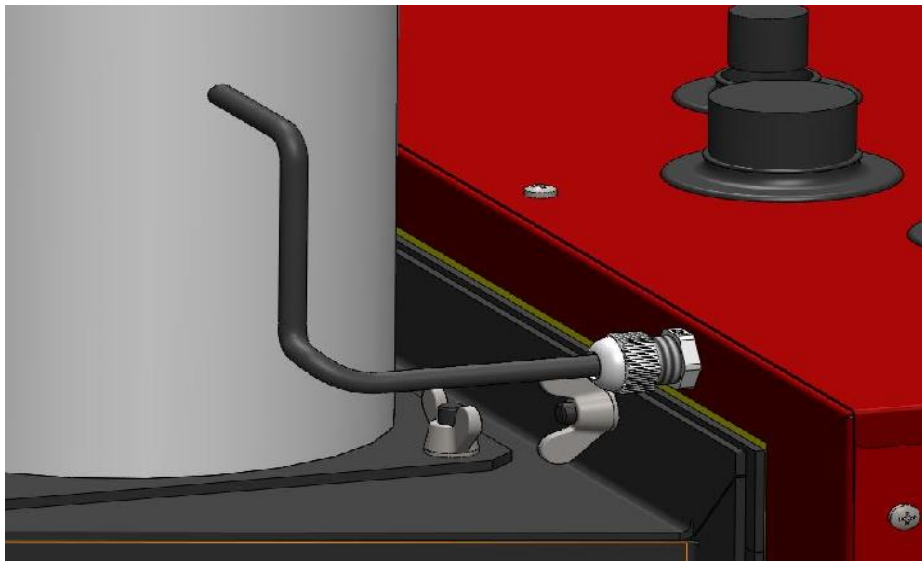

Slika 12a. Postavljanje sonde

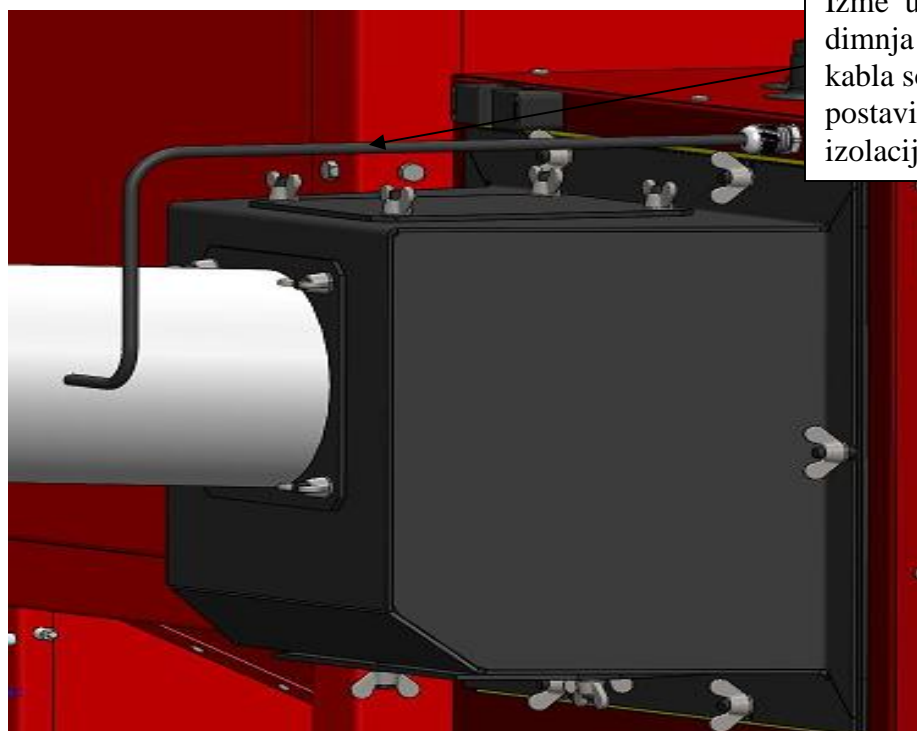

Slika 12b. Postavljanje sonde

- Uveriti se da je mehanizam za transport peleta vrsto oslonjen na pod, da je klapna ventilatora maksimalno otvorena i da je voica klapne za sigurnosni vazduh od 47 do 49 mm. (slika 13. i 14.)



Slika 13. Položaj klapne ventilatora

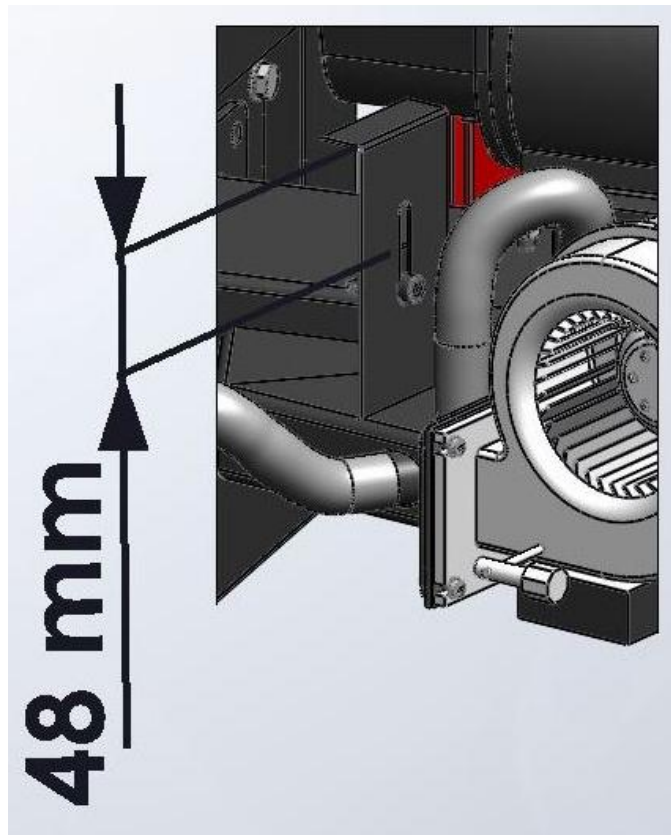

Slika 14. Položaj max. otvorene voice klapne.

- Uti nicu na zadnjoj strani kotla spojiti sa glavnim mrežnim napajanjem.
- Sipati manju koli inu peleta u silos i zatvoriti ga.
- U ovoj fazi potrebno je ubaciti pelet u komoru za sagorevanje i to radom transportnog mehanizma za pelet (pellet feeding system). Na taj na in postizemo kontinualno raspore en pelet od komore za sagorevanje pa do silosa. Do pokretanja mehanizma za pelet može do i samo u fazi rada kada na displeju piše „OFF“. Tada pritiskom na komandno dugme 2 koje u svom donjem delu i ima simbol za pužni transporter, dolazi do pokretanja mehanizma. Sve dok držimo dugme pritisnuto mehanizam radi. Kada dugme pustimo mehanizam stane.

Nalaganje komore peletom tzv. ru nom komandom vršiti nešto niže do po etka delova od sivog liva,što je prikazano **slikom 16**.



Slika 16. Prikaz nivoa peleta

- Sada kada imamo pelet u komori za sagorevanje i kada je on u zoni greja a za potpalu, možemo da startujemo po etak rada kotla.
- Start se izvodi tako što pritisnemo i držimo komandno dugme 4 više od 3 sekunde. Na donjem delu ovog dugmeta prikazan je i simbol za rastresit materijal, odnosno pelet. U trenutku kada kotao krene u potpalu na displeju piše Chc i u ovih nekoliko sekundi radi samo ventilator. Za vreme ove faze automatika proverava da li su svi ure aji neophodni za rad zaista i priklju eni. Slede i korak je kada na displeju piše Acc. Ovo je oznaka faze paljenja. Tada se osim ventilatora pali i greja za potpalu što se vidi i na automatici jer sijaju signalne lampice sa

Radijator Inženjering d.o.o, 36000 Kraljevo, Živojina Lazića - Solunca br.6, Srbija
tel. +381 36 399 140, fax. +381 36 399 150, <http://www.radijator.rs>
e-mail: radijator@radijator.rs

brojevima 2 i 7. U fazi potpale u jednom trenutku treba o ekivati da se uklju i i sistem za transport i da se nivo peleta u komori dopuni. Idealno je da kad posle ove dopune pelet bude do samog po etka delova od sivog liva.

Kotao je u fazi potpale sve dok dimni gasovi ne pre u temperaturu koja je odre ena parametrom **F18**. Prema fabri kim podešavanjima ova temperatura je **70°**. Prvo se pojavi dim a u periodu od 7 do 10 minuta i plamen.

- Kada dimni gasovi pre u grani nu temperaturu paljenja na displeju se pokazuje natpis Stb. Ovo zna i da je kotao u fazi stabilizacije plamena tj. sada automatika meri da li dimni gasovi imaju dovoljan prirast za odre eno vreme. Ventilator radi prema parametru za fazu stabilizacije, a i dolazi do dopune ložišta peletom tako e prema parametrima puža u fazi stabilizacije. U trenutku kada je i ovaj faktor zadovoljen kotao ide u radni režim.
- Kotao je u radnom režimu kada na displeju ne piše ništa osim trenutne temperature vode u kotlu. Treba sa ekati od 20 do 30 minuta i videti da li pelet gori na vrhu komore za sagoravanje. Tako e u ovom periodu treba pratiti i kolika je temperatura dimnih gasova. To se radi tako što se kratko pritisne komandno dugme 1 pa dugme 3 i na kraju dugme 2. Na displeju je tada broj koji ozna ava temperaturu dimnih gasova.

Primer parametara za ECO COMFORT 25 pri nazivnoj toplotnoj snazi. Pelet 4,76 kWh/kg	Primer parametara za ECO COMFORT 25 pri minimalnoj toplotnoj snazi. Pelet 4,76 kWh/kg
Trajanje doziranja peleta (s) 2,5	Trajanje doziranja peleta (s) 1
Pauza izme u dva doziranja peleta (s) 5,6	Pauza izme u dva doziranja peleta (s) 9,1
Brzina primara (%) 27	Brzina primara (%) 21
Ventil grane koja vodi vazduh za sagorevanje kroz zavojni transporter bio je otvoren 80%.	Ventil grane koja vodi vazduh za sagorevanje kroz zavojni transporter bio je otvoren 80%.
Klapna grane koja vodi na ubacivanje vazduha kroz otvore retorte bila je 48 mm (kao na slici 14)	Klapna grane koja vodi na ubacivanje vazduha kroz otvore retorte bila je 36mm.
Prose na snaga kotla (kW) 24,96	Prose na snaga kotla (kW) 7,44

Vreme sagorevanja:

Maksimalna toplotna mo :

- vreme sagorevanja (h) 6
- koli ina toplotne energije (kWh) 150
- koli ina utrošenog peleta (kg) 35,62
- donja toplotna mo utrošenog peleta (kWh/kg) 4,76

Minimalna toplotna mo :

- vreme sagorevanja (h) 6
- koli ina toplotne energije (kWh) 45
- koli ina utrošenog peleta (kg) 10,23
- donja toplotna mo utrošenog peleta (kWh/kg) 4,76



NAPOMENA: Ovo su izmerene vrednosti tokom sertifikovanja.

- Na automatiku može biti povezan sobni termostats. U ovom slu aju, važno je podesiti temperaturu prostorije koja je glavni parametar za rad kotla i temperaturu vode u kotlu (70°C). Kada je aktiviran rad sobnog termostata, kotao najpre ima zahtev za postizanjem temperature sobe, stim da je ograni en zadatom temperaturom vode u njemu. Postoji mogu nost da kotao prestane sa radom pre zadate temperature sobnog termostata, u ovom slu aju treba podi i zadatu temperaturu vode u kotlu npr.70°C.
- Sagorevanje peleta, bez obzira na snagu sa kojom kotao radi, neophodno je podesiti tako da je na vrhu prostora za sagorevanje (**prikazano na slici**). Ovo se postiže podešavanjem doziranja peleta i koli ine vazduha. U slu aju da nivo plamena po inje da se spušta, neophodno je da se produži vreme doziranja ili smanjenje koli ine vazduha. Ako želimo da smanjimo toplotnu mo , neophodno je da smanjimo koli inu vazduha. Ako se desi da se nivo plamena podiže, možemo da smanjimo vreme nalaganja ili pove amo koli inu vazduha. Za ta no odre ivanje parametara potrebno je pratiti proces rada najmanje sat vremena.

NAPOMENA: Uvek se treba pridržavati nominalne ili maksimalne snage sagorevanja peleta, tj.kada pelet sagoreva na vrhu gorionika. U ovom slu aju smanjenje toplotne mo i vršimo smanjenjem zadate temperature vode u kotlu ili zadate temperature sobnog termostata.

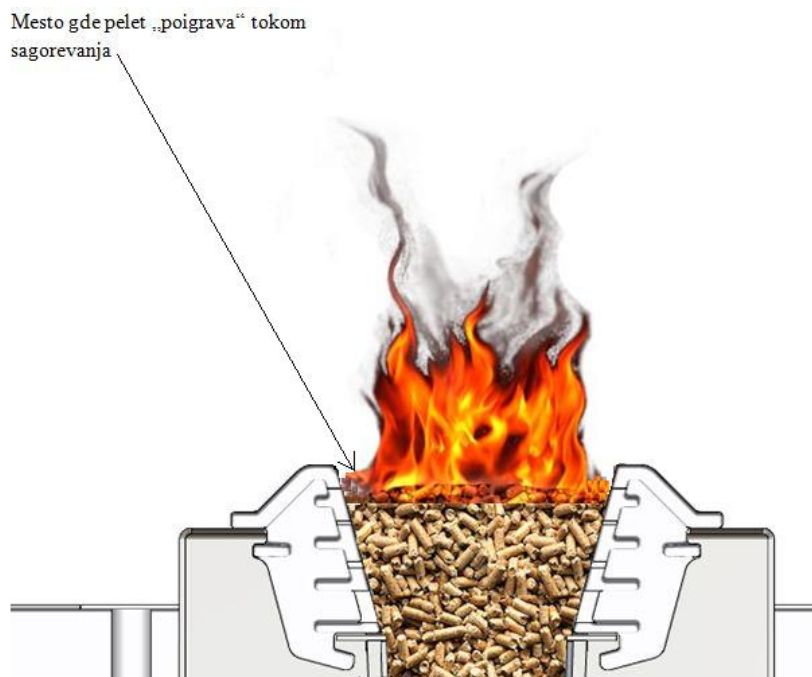

Upozorenje: Obavezno izvršiti analizu dimnih gasova nakon završetka instalacije kotla. Izmeriti procenat kiseonika (O₂).

8.3 Kratko uputstvo za upotrebu automatike

8.3.1 DOPUNA LOŽIŠTA SA PELETOM, PRIPREMA ZA PALJENJE.

- Sipati pelet u silos
- Na glavnom displeju more da piše **OFF**



- Pritisnuti i držati dugme . Sve dok držimo dugme transporter radi i na displeju piše **LOAD PELET**.

8.3.2 START POTPALE NA PELET, PREKIDA RADA NA PELET.

- Uključiti glavni prekidač

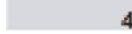

- Pritisnuti dugme  i držati 4-5 sekundi.

- Prekid rada kotla na pelet vrši se pritiskom na dugme  i držanjem 4-5 sekundi.

8.3.3 PROMENA VREMENA DOZIRANJA TRANSPORTERA U RADNOM REŽIMU.

- Pritisnuti jednom kratko ,

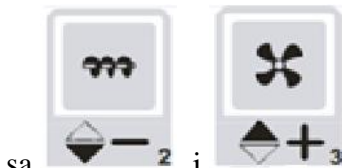

sa  i  promeniti vrednosti doziranja puža na željenu vrednost.

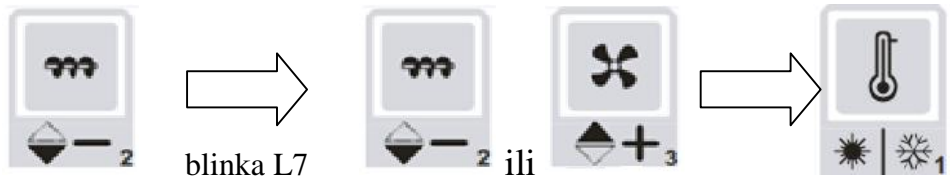

8.3.4 PROMENA JAŠINE VENTILATORA U RADNOM REŽIMU.

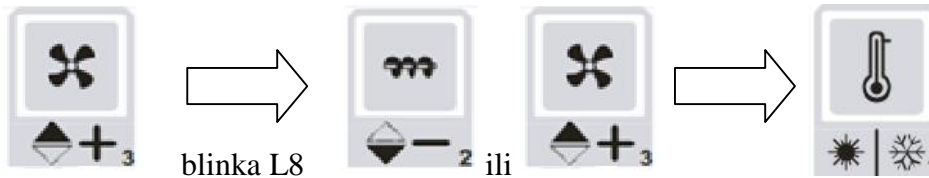

8.3.5 PROMENA ZADATE TEMPERATURE VODE U KOTLU.

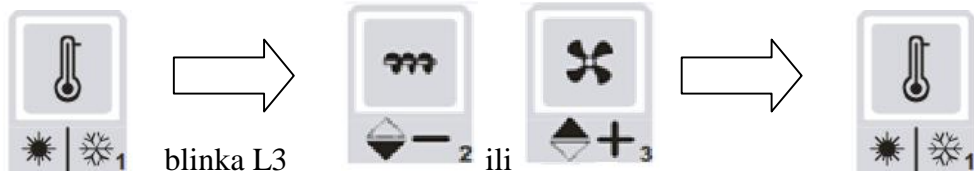

8.3.6 KAKO Očitati TEMPERATURU DIMOVODNIH GASOVA.

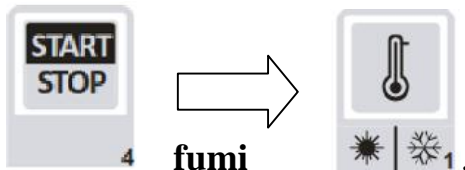

8.3.7 ULAZAK U SKRIVENI MENI.

Pritisnuti blinka L1 i blinka L3 i držati oba dugmeta 5 sekundi. Odmah po ulasku u skriveni MENI na displeju piše **CL 00**. To je prvi parametar.

8.4 Greške prilikom startovanja kotla

Sve moguće greške u početnoj fazi rada tj. prilikom potpale mogu da se podele u tri velike grupe:

- **Grupa I** . Greške u potpali koje se odnose na situaciju kada nema pojave varnica, dima ni bilo kakvog plamena više od 20 minuta od trenutka kada se upalio grejač za potpalu.
- **Grupa II** . Greške u potpali koje se odnose na situaciju kada je došlo do pojave plamena ali se kotao posle izvesnog vremena (nekoliko minuta) ipak ugasio.
- **Grupa III** . Kotao je uspešno potpalio i radio nekoliko sati. Dostigao je zadatu temperaturu i duže vremena nema potrebe da se uključe ni dozirni sistem ni ventilator (najčešće je ova situacija tokom noći). Zatim temperatura pada ili korisnik želi veću temperaturu (najčešće ujutru) i kotao dobija signal da krene u fazu potpale, ali do plamena ne dolazi.

Grupa I

Mogući **uzrok 1**.

- **PROBLEM 1** – Zatvorena klapna ventilatora za primarni vazduh. Ventilator se nalazi na dozatoru.
- Postupak za rešavanje **PROBLEMA 1** – Otvoriti klapnu ventilatora maksimalno

Mogući **uzrok 2**.

- **PROBLEM 2** – Crevo koje spaja kanal vazduha od ventilatora do grejača a nije pravilno postavljeno.
- Postupak za rešavanje **PROBLEMA 2** – Pri vratiti crevo za vazduh i na kraju iste grejača i na cev kanala za vazduh

Mogući **uzrok 3**

- **PROBLEM 3** – Prostor između grejača i cevnog kućišta u kome je zavijen grejač je zapušten sa katranom i pepelom tako da nema prodora vazduha.
- Postupak za rešavanje **PROBLEMA 3** – Očistiti ovaj prostor i to prvo probati samo sa strane unutar ložišta žicom debljine 1-2 mm. Ako ovo ne uspe isključiti kotao iz struje, odviti grejač i sada očistiti prostor u kome je smešten.

Mogući **uzrok 4**

- **PROBLEM 4** – Prostor u dubini ložišta gde sagoreva pelet je pun nesagorelih ostataka odnosno šljake tako da nema dodira peleta i vrelog vazduha.

- Postupak za rešavanje **PROBLEMA 4** – Oistiti dubinu ložišta i to prvo krupniju šljaku mehanički a sitniju je moguće pokupiti i usisivati.

Mogući **uzrok 5**

- **PROBLEM 5** – Pelet koji se koristi je velike vlažnosti.
- Postupak za rešavanje **PROBLEMA 5** – Probati sa peletom koji je većeg stepena suvoće.

Mogući **uzrok 6**

- **PROBLEM 6** – Mrežni napon na koji je priključen kotao je znatno manji od 220-230V tako da je i snaga grejača manja.
- Postupak za rešavanje **PROBLEMA 6** – Priključiti mrežni ispravljač napona ili potpaliti ručno.

Mogući **uzrok 7**

- **PROBLEM 7** – Posle ručnog nalaganja i automatske dopune ložišta u fazi potpale nivo peleta je takav da pelet nije u kontaktu sa grejačem.
- Postupak za rešavanje **PROBLEMA 7** – Dopuniti nivo peleta.

Mogući **uzrok 8**

- **PROBLEM 8** – Prebačen je kotao iz automatskog u ručni režim rada. Ako tokom faze potpale ne gori lampica za grejač onda smo sigurni da je kotao u ručnom režimu.
- Postupak za rešavanje **PROBLEMA 8** – Prebaciti kotao u automatski režim potpale.

Mogući **uzrok 9**

- **PROBLEM 9** – Neispravan elektro grejač za potpalu. Isključiti kotao iz mrežnog napajanja i na priključnim kablovima elektro grejača izmeriti omsku otpornost.
- Postupak za rešavanje **PROBLEMA 9** – Promeniti elektro grejač

Grupa II

Mogući **uzrok 1.**

- **PROBLEM 1** – Brzina ventilatora u fazi potpale. Brzina ventilatora za primarni vazduh u ovoj fazi je određena parametrima Uc00 i Uc01. Ukoliko je brzina drastično promenjena u odnosu na fabrički podešenu nije dobro ni znajući je smanjiti ni povećati. U slučaju kad je ventilator u potpali slab onda nema porasta temperature dimnih gasova a ako je prejak može doći do brze potrošnje peleta u komori što opet dovodi do smanjenja temp. dimnih gasova u potpali.

- Postupak za rešavanje **PROBLEMA 1** – Podesiti vrednosti parametara Uc00 i Uc01 na fabri ke ili blizu fabri kih.

Mogu **uzrok 2**

- **PROBLEM 2** – Brzina ventilatora u fazi stabilizacije plamena. Kotao u e u potpalu, pojavi se dim, na displeju piše Stb što zna i da je u fazi stabilizacije plamena ali posle toga kotao se ugasi. Naj eš e uzrok ovome je preslab ventilator u fazi stabilizacije što je odre eno parametrom Uc04.
- Postupak za rešavanje **PROBLEMA 2** – Poja ati brzinu ventilatora parametrom Uc04.

Mogu **uzrok 3**

- **PROBLEM 3** – Previše ili premalo peleta u fazi stabilizacije. Ako ima malo ili previše peleta dok na displeju piše Stb tj. stabilizacija, može do i do zagušenja plamena i vra anja kotla u stanje gašenja. Koli ina peleta u fazi stabilizacije se reguliše parametrom CL04.
- Postupak za rešavanje **PROBLEMA 3** – vrednost parametra CL04 na fabri ku ili blisku fabri koj.

Mogu **uzrok 4**

- **PROBLEM 4** – Kotao je ušao u fazu stabilizacije ali ide u fazu gašenja jer nema dovoljan prirast temperature dimnih gasova. Naro ito je stagnacija odnosno mali pad temperature dimnih gasova uo lživ u trenutku kada kre e dopuna ložišta sa peletima.
- Postupak za rešavanje **PROBLEMA 4** – Podi i temp. dimnih gasova za ulazak sistema u Fire ON a to je parametar F18. Na taj na in novi pelet koji ulazi u komoru za sagorevanje teže obara temp. dimnih gasova jer je plamen ja i iz razloga što mu se dalo više vremena do trenutka dopunjavanja. Ovaj problem se naj eš e javlja kad su slabi dimnjaci ili je vu a dimnjaka iz nekog drugog razloga slaba.

Grupa III

Uvod

Kada kotao dostigne zadatu temperaturu vode u njemu ili vazduha u prostoriji gde je sobni termostat, prelazi u fazu mirovanja, odnosno održavanja plamena ili u originalu Standby fazu. Najbolji primer za ovakav na in rada kotla je no ni rad.

Osnovni cilj ove faze je održati plamen odnosno žar u ložištu tokom višesatnog mirovanja. To se postiže periodi nim uklju ivanjem i pelet transportera i ventilatora u odre enim periodima vremena.

- U trenutku kada je kotao dostigao zadatu temperaturu on ulazi u fazu održavanja plamena. Posle odre enog perioda vremena, što je odre eno parametrom t04 (u

minutima) transporter kreće u rad i ventilatori se aktiviraju. U ovim periodima dolazi do aktiviranja kotla sve dok ne dobije komandu za start zbog postizanja zadate temperature.

- Vreme trajanja jednog procesa rada transportera i ventilatora određeno je parametrom t05 (u sekundama).
- Tokom samog procesa uključivanja transportera njegov rad je određen, periodom što je određeno parametrom CL09 (u sekundama).
- Za vreme procesa održavanja plamena ventilator za primarno sagorevanje se uključuje sa snagom koja je određena parametrom Uc09.

Moguće greške u radu vezane za fazu održavanja plamena:

- Kotao i pored funkcionisanja faze održavanja plamena nema dovoljno peleta za start i rad u normalnom režimu.
- Otklanjanje uzroka greške :
 1. Smanjiti parametar t04, odnosno povećati u estanost rada transportera i ventilatora u fazi mirovanja.
 2. Povećati vreme trajanja procesa tj. parametar t05.
- Previše nesagorelog peleta pri kretanju kotla u rad.
- Otklanjanje uzroka greške :
 1. Povećati parametar t04
 2. Smanjiti parametar t05
 3. Smanjiti snagu ventilatora za primarno sagorevanje u fazi održavanja plamena parametar Uc09.

8.5 Održavanje kotla ECO COMFORT

Kotao ECO COMFORT 25 zahteva svakodnevno i periodi no iš enje.

- Svakodnevno iš enje se odnosi i na prostor samog ložišta od sivog liva gde stalnim izbacivanjem pepela omogu avamo bolji rad elektro greja a za potpalu i bolje sagorevanje tj.ve u koli inu vazduha kroz vazdušne kanale u sivom livu. Tako e pepeo ve u toku dana po inje da se taloži na podu, prostoru oko samog ložišta. Pri prose nim parametrima sagorevanja 100kg peleta proizvede 1kg pepela.
- Na svakih 3 do 7 dana potrebno je o istiti prostor oko segmenata sivog liva za sagorevanje peleta (**slika 18.**). Tako e potrebno je o istiti naslage na zidovima samog ložišta. Ovim dobijamo bolji stepen prenosa jer jedan milimetar naslaga katrana i a i smanjuje provodnost za 5%.
- Na svakih 3 do 7 dana potrebno je otvoriti i gornji vrata za iš enje, izvaditi turbulatore i sa celog tada dostupnog dela kotla skinuti katran i a (**slika 18.**).

Ukoliko se u kotlu, tokom koriš enja javi kondenzacija, potrebno je pokupiti kondenz a ceo kotao iznutra premazati baznim sredstvima za iš enje ili barem vodenim rastvorom gra evinskog kre a. Na taj na in se vrši neutralizacija kiselina usled kondenzacije.



Pri održavanju i servisiranju kotla, kotao isklju iti sa napajanja.

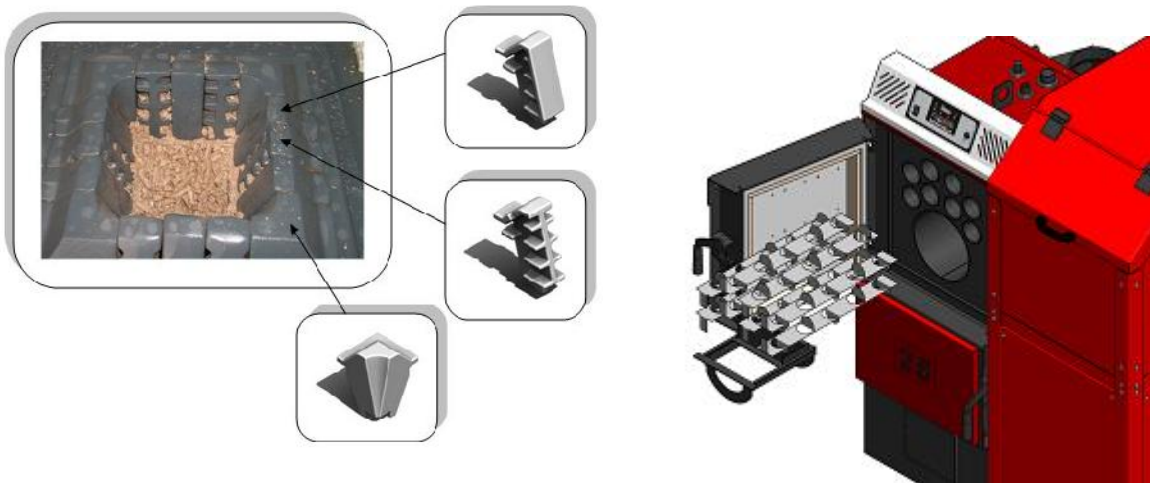

Slika 18. Prikaz vadjanja turbulatora iz kotla ECO COMFORT 25 i demontaža livenih segmenata ložišta



Na ovaj na in obavezno konzervirati kotao na kraju grejne sezone. U toj situaciji zatvoriti i sve otvore na kotlu da ne dodje do cirkulacije vazduha kroz kotao jer i tako može do i do pojave vlage u kotlu.



Održavanje kotla je jedan od najbitni faktora za dužinu radnog veka kotla. Naro ito je bitno da u vansezoni kotao bude o iš en i da se izvrši eutralizacija kiselina na ve opisan na in.

8.6 Natpisna plo ica

Natpisna plo ica je nalepljena na dobro vidljivo mesto na kotlu i sadrži slede e (videti sliku u ta ki NALEPNICE):

1. Tehni ki podaci sa nalepnice:

- Proizvo a (Radijator inženjering)
- Serijski broj kotla (primer: N°:120116002)
- Godina proizvodnje (primer: 2016)
- Tip kotla (ECO COMFORT 25)
- Nazivna toplotna snaga kotla (ECO COMFORT 25 – 25,26kW)
- Podru ije upotrebe toplotne snage (ECO COMFORT 25– 7,41–25,26kW)
- Potrebna promaja dimnjaka (ECO COMFORT 25 – 15Pa)
- Elektri ni napon (230V)
- Frekvencija (50Hz)
- Ja ina struje (3,04A)
- Nazivna el. snaga (500W)
- Maksimalna dodatna el. snaga (200W)
- Ukupna el.snaga (700W)
- Težina (ECO COMFORT 25 – 428kg)
- Razred kotla – na pelet (C1)
- Maksimalni pritisak (3 bar)
- Maksimalna temperatura (90°C)
- Koli ina vode izražena u litrima (ECO COMFORT 25 – 85L)
- Oznaka tipa goriva – pelet C1

2. Nalepnica uvoznika

3. OEEQ

4. Ostale oznake na kotlu



8.7 Izjave



IZJAVA O USAGLAŠENOSTI

U skladu sa direktivom 2006/42/EC o mašinama
Prilog II, deo 1, odeljak A

U ime: "RADIJATOR Inženjering-a" d.o.o. /Živojina Lazića Solunca 6, 36000 Kraljevo, Srbija

IZJAVLJUJE

S potpunom odgovornošću da:

Grejni kotlovi na pelet serije ECO COMFORT nominalne toplotne snage:
Eco Comfort 25 - 25,26kW; Eco Comfort 45 - 44,18kW.

ispunjavaju zahteve: Direktive 2006/42/EC o mašinama (stupila na snagu 29/06/2006),

i zahteve sledećih direktiva i propisa:

1. Direktive 2004/108/EC Evropskog Parlamenta i Saveta od 5. Decembra 2004 o približavanju zakonodavstava država članica u vezi elektromagnetne kompatibilnosti (tekst značajan za EEP) i stavljanja van snage Direktive 89/336/EEC;
2. Direktive 2006/95/EC Evropskog Parlamenta i Saveta od 12. Decembra 2006 o usklađivanju zakonodavstava država članica u vezi električne opreme namenjene za upotrebu u okviru određenih granica napona (kodifikovana verzija) (tekst značajan za EEP) i stavljanja van snage direktive 73/23/EEC

Uređaj je usaglašen sa sledećim EU standardom:
EN 303-5:2012,

i sledećim EN i tehničkim zahtevima: EN 60730-1.

Mesto: Kraljevo
Datum: 2015-07-01

Potpis: 
Milan Janić, generalni direktor

8.8 Nalepnica

Na kotlu Eco Comfort nalaze se nalepnice za označavanje priključaka kao i nalepnice za opasnost od strujnog udara, nalepnice za šemu povezivanja i dr.

Nalepnice koje označavaju priključke za povezivanje instalacije:

1. Nalepnica (Potisni vod) 32mm x 74mm



2. Nalepnica (Povratni vod) 32mm x 74mm



3. Nalepnica (Sigurnosna grupa) 32mm x 74mm



4. Nalepnica (Punjenje/praznjenje) 32mm x 74mm

PUNJENJE/PRAŽNJENJE
cold water inlet/outlet

5. Nalepnica (Izmenjiva termi kog osiguranja) 32mm x 74mm

IZMENJIVAČ TERMIČKOG
OSIGURANJA
inlet/outlet of thermal safety
relief valve

6. Nalepnica (Sonda termi kog osiguranja) 32mm x 74mm

SONDA VENTILA
TERMIČKOG OSIGURANJA
probe of temperature safety
relief valve

7. Nalepnica (Šema povezivanja) 152mm x 210mm

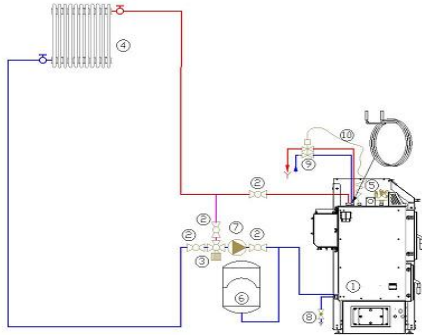

Nalepnice koje označavaju prisustvo struje, visokog napona i opasnosti:

1. Nalepnica (Napon opasan po život) 60mm x 80mm



2. Nalepnica (Ulaz za sniženim naponom 12V) 60mm x 80mm



3. Nalepnica (Napon opasan po život - VE A) 100mm x 150mm



4. Nalepnica (Uzemljenje) 20mm x 30mm



5. Nalepnica (Prisustvo napona)



Nalepnice koje označavaju upozorenje:

1. Nalepnica (Izloženi pokretni delovi mogu izazvati povrede) 30mm x 80mm



2. Nalepnica (Obavezno poštovanje u rad od strane ovlašćenog servisa)
65mm x 247mm



3. Nalepnica (Pažnja)



4. Nalepnica (Otpad)



Nalepnice sa tehni kim podacima:





Živojina Lazića Solunca br.6
Grdica-36000 Kraljevo
Srbija

N^o 120116002

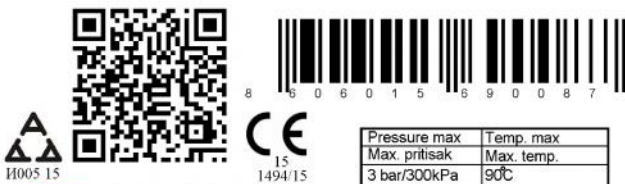
Eco Comfort 25



		<table border="1"> <tr> <td>Pressure max</td> <td>Temp. max</td> </tr> <tr> <td>Max. pritisak</td> <td>Max. temp.</td> </tr> <tr> <td>3 bar/300kPa</td> <td>90°C</td> </tr> </table>	Pressure max	Temp. max	Max. pritisak	Max. temp.	3 bar/300kPa	90°C
Pressure max	Temp. max							
Max. pritisak	Max. temp.							
3 bar/300kPa	90°C							
	Živojina Lazića Solunca br.6 Grdica-36000 Kraljevo, Srbija e-mail: radijator@radijator.rs www.radijator.rs	N ^o : 120116002 Godina/Year: 2016						
PROIZVOĐAČ MANUFACTURER	Radijator Inženjering							
TIP - MODEL TYPE - MODEL	Eco Comfort 25							
NAZIVNA TOPLOTNA SNAGA KOTLA NOMINAL HEAT OUTPUT POWER	25.26 kW							
PODRUČJE UPOTREBE TOPLOTNE SNAGE HEAT OUTPUT RANGE	7.41 - 25.26 kW							
POTREBNA PROMAJA DIMNJAKA REQUIREMENT AIR FLUE	15Pa							
ELEKTRICNI NAPON VOLTAGE	230 V							
FREKVENCIJA FREQUENCY	50 Hz							
JACINA STRUJE CURRENT	3.04 A							
NAZIVNA EL. SNAGA NOMINAL ELECTRICAL POWER	500 W							
MAX. DODATNA EL. SNAGA MAX. EXTENDED EL. POWER	200 W							
UKUPNA EL. SNAGA ALL EL. POWER	700 W							
MASA KOTLA MASS OF BOILER	428 Kg							
ZAPREMINA VODE U KOTLU VOLUME OF WATER IN THE BOILER	85 L							
KLASA KOTLA PD EN 308-5:2012 CLASS OF BOILER ACCORDING TO EN 308-5:2012	5							
GORIVO FUEL	C1							

Radijator Inženjering d.o.o, 36000 Kraljevo, Živojina Lazića - Solunca br.6, Srbija
tel. +381 36 399 140, fax. +381 36 399 150, http://www.radijator.rs
e-mail: radijator@radijator.rs



8.9 Proizvođa



RADIJATOR D.O.O.
Živojina Lazija Solunca br.6
36000 Kraljevo, Srbija

Radijator Inženjering d.o.o, 36000 Kraljevo, Živojina Lazija - Solunca br.6, Srbija
tel. +381 36 399 140, fax. +381 36 399 150, <http://www.radijator.rs>
e-mail: radijator@radijator.rs

9. Garancija

1. Radijator inženjering pokriva razli ite garancijske periode za razli ite delove (što je navedeno u daljem tekstu) samo ako su ispunjeni slede i uslovi garancije:

- 1.1. Kotao mora biti priklju en po navedenim hidrauli kim šemama iz tehni kog uputstva, naro ito obratiti pažnju na sigurnosne ventile, termi ko osiguranje oticanjem, mešaju i ventil za zaštitu hladnog kraja kotla odnosno protiv kondenzacije, opseg radnog pritiska kotla, opseg radne temperature kotla, uslove u kotlarnici itd.
(videti ta ku 7.)
- 1.2. Kotao mora biti priklju en na dimnjak propisanog popre nog preseka, karakteristika izolacije i visine. (videti ta ku 3.4)
- 1.3. Dimovod od kotla do dimnjaka mora mora biti izveden po tehni kom uputstvu.
- 1.4. Kod kotla moraju biti izvršena i navedena elektro priklju enja iz tehni kog uputstva, naro ito se misli na karakteristike sobnog termostata, karakteristike mrežnog napona koji mora biti u odre enim granicama.
- 1.5. Korisnik mora da se pridržava navedenih uputstava o koriš enju i održavanju.
(videti ta ku 8.)

2. Garancijska izjava

Izjavljujemo:

- da proizvod ima propisana i deklarirana kvalitetna svojstva.
Obavezujemo se, da emo na zahtev kupca ako pravovremeno u garancijskom roku podnese zahtev za popravku, o svakom trošku izvršiti sve popravke kvarova, tako da e proizvod raditi u skladu sa deklariranim svojstvima,
- da e proizvod u garancijskom roku raditi besprekorno ako se budu poštovala uputstva za upotrebu, rad i montažu,
- da emo u garancijskom roku biti spremni da otklonimo sve kvarove na proizvodu i držati na zalihama sve potrebne rezervne delove,
- **garancijski rok po inje od DANA KUPOVINE I TRAJE 60 MESECI ILI 72MESECA OD DATUMA PROIZVODNJE (datum proizvodnje nalazi se na nalepnici sa zadnje strane kotla),**
- **GARANCIJA OD 60 MESECI VAŽI SAMO AKO SE KOTAO REDOVNO SERVISIRA OD STRANE CENTRALNOG SERIVISA RADIJATOR INŽINJERINGA u periodu nazna enom za isti (dalje u tekstu),**
- **garancija važi ako je garantni list overen od strane prodavca i ako je upisan datum kupovine i priložen ra un. TAKO E BITNO JE IMATI I NALOG ZA PUŠTANJE U RAD. (overen od strane ovlaš enog servisa)**

3. Garancijski period od godinu dana važi za slede e delove:

- Za sve ležajeve serije UCFL,
- elektro greja a za potpalu,
- Ležajeve elijastog sigurnosnog transportera (valvole),

4. Garancijski period od dve godine važi za slede e delove:

- Motor reduktor,
- lance za prenos obrtnog momenta 083,
- donje pužne spirale,
- ventilator primarnog vazduha,
- automatiku kotla sa sigurnosnim termostatom,
- sondu dimovodnih gasova,
- sondu temperature kotlovske vode.
- segmente za sagorevanje od sivog liva,
- elektro konektore,
- izolacijske materijale na vratima i otvorima za iš enje,
- delove elijastog sigurnosnog transportera (valvole) koji su od sivog i nodularnog liva.

5. Garancijski rok ne važi:

- ukoliko se posle svake grejne sezone ne odradi redovan servis,
- za zamenu delova kod redovnog godišnjeg održavanja u skladu sa uputstvima,
- kod kvarova koje je na inio kupac zbog nestru nog rukovanja proizvodom,
- kod mehani kih kvarova na injenih prilikom transporta i prilikom koriš enja(vrsti predmeti),
- ako je proizvod instaliran nestru no, suprotno važe im propisima iz tog podru ija,
- ukoliko se utvrdi da hidrauli ka šema nije ura ena po preporukama firme „Radijator inženjering”,
- ako je kupac koristio proizvod iznad deklariranih svojstava i u normalnim okolnostima,

6. Garancijski rok prestaje da važi:

- ako se ustanovi da je kvarove otklanjala neovlaš ena osoba ili neovlaš eni servis,
- ako kod popravke nisu bili upotrebljeni i ugra eni originalni delovi,
- kad isti e garancijski rok.

7. Kod prijave kvarova obavezno je dati sledeće podatke:

- naziv i tip proizvoda,
- datum kupovine,
- fabrički ili radionički broj kotla,
- kratak opis kvara, odnosno nedostatka,
- tačnu adresu i kontakt telefon, mejl.

8. Redovan godišnji servis

Redovan servis se održava na kraju svake grejne sezone u period od 15.4. do 31.8. i naplaćuje se utvrđenim cenovnikom firme “Radijator Inženjering”. Servisni postupak tehničkih lica koja obavljaju redovne godišnje servise, a koja su od strane proizvođača ovlašćena za to, obuhvataju sledeće operacije:



NAPOMENA: Serviser je dužan da pregleda sve navedene delove (sa liste) dozatora i izmenjivača, i ukoliko dođe do zamene bilo kojih delova na iste korisnik dobija gore navedenu garanciju kao i garanciju na još 12 meseci na telo kotla (izmenjivača). Garancija se može produžiti do 5 god. od datuma puštanja u rad. Servis i produženje servisa može da obavlja lice koje šalje centralni servis “Radijator inženjering”-a. Na nezamenjene delove posle održavanja servisa garancija ne važi.

- Demontaža silosa za pellet od pellet transportera;
- Demontaža pellet transportera od kotla;
- Skidanje oba lanca;
- Demontaža segmenata za sagorevanje od ložišta i išćenje prostora ložišta ispod segmenata. Provera stanja segmenata i njihovog međusobnog zazora;
- išćenje prostora cevi ložišta u kojoj se okreće donja pužna spirala;
- Podmazivanje svih ležajeva gornje i donje pužne osovine i provera njihove ispravnosti. Ležaj ne sme da ima otežano okretanje ili naprsline na kućištu. U suprotnom ležaj se menja. Ukoliko se utvrdi da je do oštećenja ležaja došlo zbog upadanja vrstog predmeta u pelet transporter (zbog greške korisnika ili proizvođača peleta), Radijator inženjering naplaćuje vrednost ležaja. Ako je do oštećenja ležaja došlo zbog povlaćenja plamena u sam pelet transporter i to iz razloga loše postavljenih parametara prilikom korišćenja, Radijator inženjering naplaćuje vrednost ležaja;
- Skidanje lanaca sa obe strane vratila elijastog sigurnosnog transportera (valvole) i provera ispravnosti ležajeva 6004 u valvoli. Ukoliko je okretanje ležajeva otežano, zameniti ležajeve sa obe strane. Ukoliko je do oštećenja ležaja valvole došlo zbog upada

vrstog tela koje nije iz samog kotla (zbog greške korisnika ili proizvođača peleta)
Radijator inženjering naplaćuje vrednost ležajeva;

- Proveriti oštrinu ivica rotora;
- Izvaditi sondu dimnih gasova i očitati je od naslaga;
- Provera ventilatora;
- Provera dihtovanja gornjih i donjih vrata;
- Provera održavanja kotlovske izmenjivača.

Contents:

1. Important warning;
 - 1.1 Minimum distance from flammable materials;
2. Description of the boiler;
3. Assembly;
 - 3.1 General warnings;
 - 3.2 Measures and safety devices for boilers ECO COMFORT;
 - 3.3 Boiler room;
 - 3.4 Connection to the chimney;
4. Cross-section of ECO COMFORT 25 boiler with a description of the boiler elements;
5. Schematic connection of automation;
6. Table of technical data;
7. Hydraulic scheme;
8. Boiler operation and maintenance;
 - 8.1 Control panel;
 - 8.2 Operation start of the boiler operated by biomass;
 - 8.3 Short manual for automatic control;
 - 8.4 Mistakes during ignition and start of the boiler;
 - 8.5 Maintenance of boiler;
 - 8.6 Nameplate;
 - 8.7 Declaration;
 - 8.8 Sticker;
 - 8.9 Manufactured;
9. Warranty.

1. Important warnings

GENERAL WARNINGS

- After the removing of the package check for the completeness of the delivery, in the case of defects, please contact the dealer who sold the boiler.
- The boiler must be used solely for the purpose envisaged by the manufacturer. Any liability of the manufacturer is excluded for damages to persons, animals or things, in case of errors during installation, regulation, maintenance or improper use.
- In case of leakage of water the device should be switched from the mains supply, close the water supply and inform the authorized service and authorized installers.
- This manual is an integral part of the device and must be kept with care and must always follow the device even in case of change of owner or user, or in case of connection to another installation. In case of damage or failure look for a new copy of an authorized dealer.



IMPORTANT WARNINGS

We emphasize that the use of the device working on bio-mass, having contact with electricity and water, demands respect and security measures such as:

- The use of the boiler by the children and people with limited capabilities without accompaniment is not allowed.
- It is forbidden to use boiler installations operating at temperatures higher than 110 ° C, and pressure greater than 3 bar.
- It is not allowed to use easily inflammable fuels (alcohol, oil) for faster ignition.
- It is forbidden to store easily flammable materials near the boiler and close the door for firing. The ashes must be disposed off in closed and non-flammable containers.
- It is prohibited to incinerate waste materials which cause combustion flame or explosion hazard (eg. plastic bags, sawdust, coal dust, mud, etc.).
- It is prohibited to any person or technical intervention or cleaning the boiler before it is switched off the main power supply switch, the setting on the device (0) "off".
- It is prohibited to change the safety elements.
- It is forbidden to close the vents in the room where the boiler is located. Air vents are needed for proper combustion.
- No exposure to atmospheric turbulents. The boiler is not designed for outdoor use and contains no anti-freeze system.
- It is forbidden to turn off the boiler when the outside temperature can drop below zero (to prevent freezing).
- Be aware of safety air valve position (detailed explanation in the chapter **OPERATION START OF BOILER**).
- In the case of intervention on any electrical device of boiler, switch off all the electrical wiring and so it is removed from the mains socket.

- Work with of boiler unit is forbidden for people with special needs (including children) to physical and mental health, except under the supervision of a guardian, and the people who are responsible for their behavior.
- Children must be supervised by a guardian as they do not play with the appliance boiler.
- If the damaged power protection, must be replaced in the factory and serviced by an authorized dealer or qualified people to avoid the risk of electric shock.

1.2 Minimum distance from flammable materials

- Provide adequate distance from flammable materials, if necessary to ensure the protection of the same.
- Minimum distance from flammable materials is required by law - please inquire of professionals who deal with heating and Emission effluents.
- The minimum distance of the boiler and flue pipe gas from the low and averagely combustible materials should be at least 100mm.
- Minimum distance from flammable materials is 200mm, and the same goes for materials whose flammability is not known.



Risk of fire!

- Storage of flammable materials and liquids in the vicinity of the boiler is prohibited.
- Be sure to warn users about the required minimum distance of combustible material from the boiler.

Combustibility of Construction materials	
A ... Noncombustible	asbestos, stone, building stone, ceramic wall tiles, terracotta, plaster, screed (without organic additives)
B... Non easily flammable	Gypsum cardboard slab, glass fiber slab of ACUMINE, ISOMINE, ROYALITE, LIGNOS, VELOX, HERACLITE
C1.. Low combustible	beech and oak wood, composite wood, file, slab of HOBREX, Versalite, umakart
C2 ... Averagely combustible	wood of pine, yew and pine, composite materials
C3... Easily combustible	Asphalt, paperboard, cellulose materials, chipboard, cork, polyurethane, polystyrene, polypropylene, polyethylene fiber floor

2. Description of the boiler

Boiler ECO COMFORT is developed as the Company RADIJATOR ENGINEERING might offer to the market the boiler, which by its mechanical and thermal properties is specially intended for biomass as fuel. Using the general term "**BIOMASS** ", of course, it is primarily meant and considered - the pellet, but it should be noted and the possibility of firing the seeds of fruit (cherries, blackcherries...). **If the user wants to use some form of biomass that is not listed, be sure to call the service design and development RADIJATOR INŽENJERING or an authorized dealer, because very often some forms of biomass require a separate, specific combustion solutions.** When using these fuels means the automatic control of the main operating parameters. In all stipulated examples of using biomass it requires a certain degree of dryness of the fuels.

Wood pellets are produced from 100 % cellulose. Wood residues under high pressure are compressed into pellets of 6 mm in diameter and in length of 2- 3cm. Pellets should be stored correctly in a dry place to ensure efficient combustion. Boilers ECO COMFORT 25 and ECO COMFORT 45 use pellet of 6mm diameter, of 5 -30mm length and humidity up to 10 % manufactured in accordance with **EN 14962-2**.

Series of boilers ECO COMFORT IS MANUFACTURED in two variants: ECO COMFORT 25 and ECO COMFORT 45. ECO COMFORT 25 covers the power range of 15 – 25 kW and ECO COMFORT 45 is in the range of 30 –45kW.

CONSTRUCTION

The water portion of the boiler, its mode of heat exchange between the flue gas and water is adjusted to the application of biomass and coal. Due to the use of fans, ie. Due to forced draft the path of flue gas is longer than with standard boilers. For the same reasons it is possible to use a router for flue gases, the so-called turbulators, which increase the degree of efficiency of the boiler.

Efficiency of pellet is over 91 %. In normal mode the flue gas temperature at the exit is about 170 ° C, and in maximum regimes it is below 210 ° C. These values may at any time to observed on the display. Each ECO COMFORT boiler has a copper heat exchanger for the connection of the fan for thermal safety. All parts of the water portion of boiler are made of seamless pipe ST 35.4 quality and boiler plate thickness of 5 mm or more, depending on the power of boiler. Sheets are of the quality of the Standard 1.0425 EU i.e. Standard P265GH EUII.

Combustion chamber, in its principle of work. The so-called under (bottom) feeding, where the zone of transport of fuel is going vertically upwards i.e. it springs up to the combustion zone. It is made of solid insulating materials and cast iron. Fuel transport is provided by screw transporters. The fuel is coming from the silo of the capacity of 240 L. If necessary, it is easy to

dismantle the whole assembly into three independent entities: silo, the mechanism for setting and boiler.

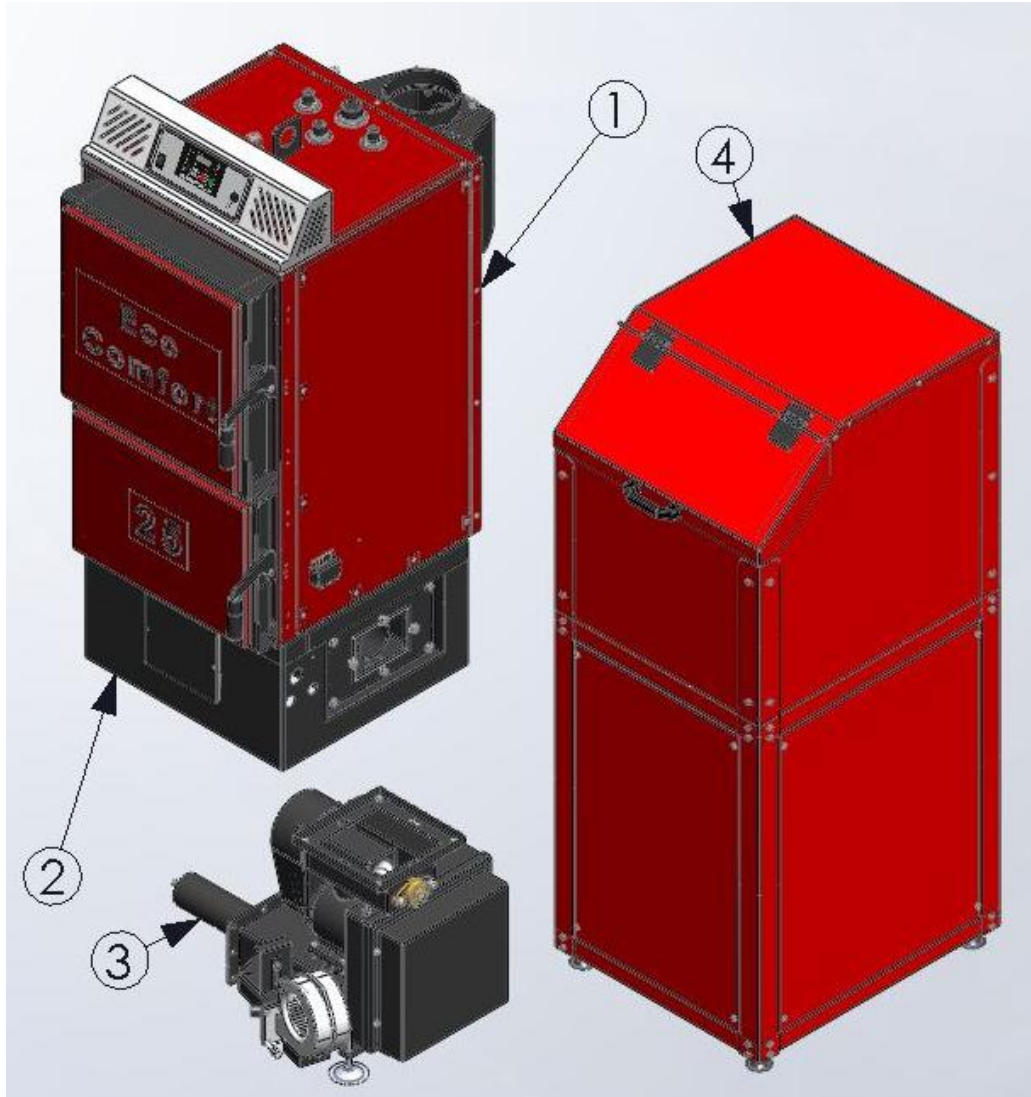

Figure 1. Parts of boiler

Discription:

1. Body of boiler;
2. Combustion chamber;
3. Feeder;
4. Silos;

3. Assembly

3.1 General warnings

The boiler must be set correctly for proper operation!

The boiler is supplied with an external coating containing insulation, 30mm thick. The position of the silo and the mechanism of transport of pellets is a standard factory right in relation to the boiler. It is possible to order the factory assembled and left variant. Also, if you need to easily make changes in the field because the silos and the whole mechanism disassemble dosing in relation to the boiler. Electrical connections easy switch ON, OFF, and for reassembly it is not necessary to have trained expert.



Silos for ECO COMFORT 25 and ECO COMFORT 45 have a flexible connection with the transport mechanism, in order to avoid vibration during operation.

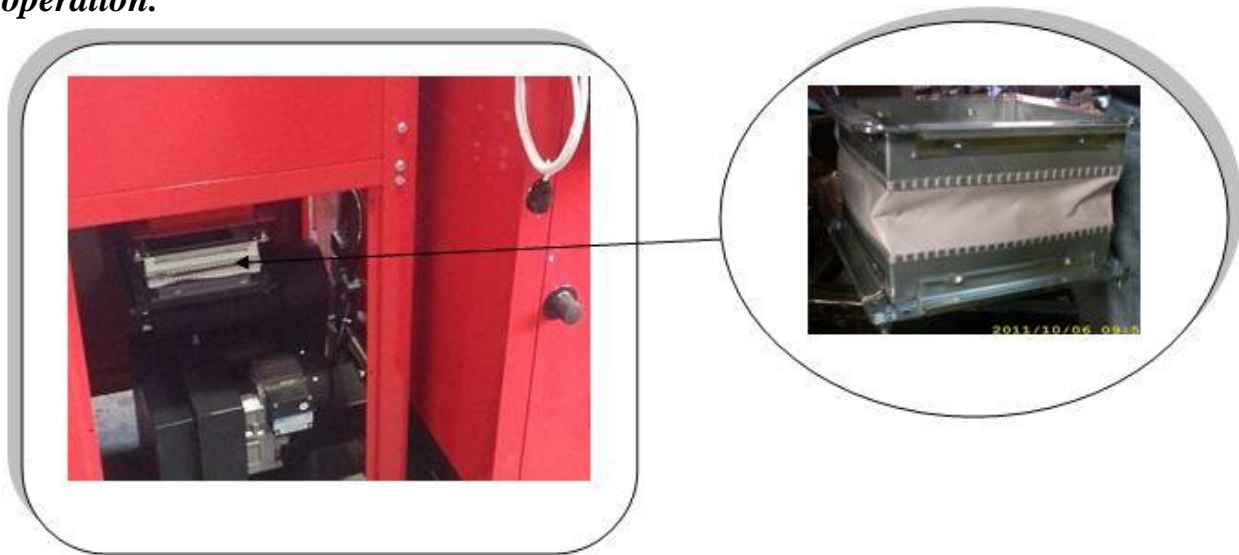

Figure2. Preview flexible connections



Maximum operating pressure of the boiler is 3 bar, 1 bar the minimum and maximum operating temperature of the boiler is 110 C.



Solid fuel boiler and forced draft should be installed according to valid standards and legal regulations. Any mechanical or electrical change in the design or installation shall be deemed a violation of guarantee conditions and will lead to its distortion.



The boiler together with a fan and automation system and both devices, use the power supply of 230V, so that improper installation and careless handling can endanger human lives by electric shock.



In an assembly the boiler should be properly protected against the excessive overpressure and overheating.



For the proper installation the plumber/installer is responsible.



The manufacturer (Radijator inženjering) does not take any responsibility coming from the incorrect installation of the boiler.

The basic requirements to be complied with during the installation:

- The boiler can be connected to an open system of central heating, but also to a closed system of central heating. In case of connection to a closed system, it is recommended to install the valve for thermal insurance, which is determined by the respective laws of each state in which the boiler is connected.
- The boiler must be located at a safe distance from combustible materials.
- Electric power for the Boiler is 230V 50Hz and connection of all devices that the boiler has should be done according to valid regulations and connection is done by a person with proper authority.
- Connection to the chimney also done according to the binding regulations and manufacturer's recommendations as can be seen below.

3.2 Measures and safety devices for boilers ECO COMFORT;

For safe operation of boiler it is necessary to assemble and maintain the following elements in working condition:

- **Pressure Safety valve (figure 3)**



Figure 3.



Figure 4.



Figure 5.

- Pressure safety valve must be of nominal diameter of 1/2 inch calibrated to a maximum of 3 bars.
 This security element which belongs to the group of pressure limiters must be of such construction to withstand short-term overdrafts and temperatures and pressure as well as the content in the liquid glycol for heating.
 Usually in the same place the vent (**Figure 4**) and the pressure gauge (**Figure 5**) are connected so that these three elements together constitute a security group and can be mounted over T" connector.
 This safety element must be subjected to periodic re-calibration , of which the investor, i.e. the user of the boiler must have valid documentation.
- Safety valve must be mounted on the highest point directly to the boiler and the boiler without any pipeline or any other elements in between. For this purpose there is a specially designed connector (see picture). Any reduction in diameter of the connector is prohibited.
- Exhaust part of safety valve must be made by conduit which have radius at least equal to radius of the exhaust part of the valve. Also it is allowed for its production to use at most one arc with radius $r > 3d$.
- The safety valve must have a nameplate and the following information on it
 - Name of manufacture;
 - Designation of type of safety valve / year of testing;
 - Nominal flow rate;
 - Data for which thermal effect the safety valve is set;
 - The highest opening pressure 3 bars.
- It is obligatory to check the correct functioning at regular intervals as well as the re-calibration by certified companies. These responsibilities are carried out in accordance with the law of every country in which the boiler is assembled. Always keep the written documentation of the last calibration data for the safety valve.

- On the return line assemble at least another pressure safety valve.
- Over temperature relief valve from group of thermal safety values (**Figure 6**)



Figure 6.

This safety element also has a role of a limiter of temperature. Below it will be marked with the abbreviation over temperature relief valve from group of thermal safety values.

- In some extremely dangerous situations in the transformation of water into vapor is such that the pressure safety valves are not sufficient to ensure the safety of the hydraulic system. For this reason, the installation of over temperature relief valve from group of thermal safety values is mandatory. Depending on the regulations of the countries in which the boiler is assembled, it is necessary to install the over temperature relief valve from group of thermal safety values only for the determined higher powers or for each power of a boiler it is the obligatory to instal the over temperature relief valve from group of thermal safety values.
- Place the installation is shown in the Assembly diagram of boiler onto the installation in **Figure 7**. The boiler is supplied with a copper coil so it is necessary to use the over temperature relief valve from group of thermal safety values with the exchanger, as shown in **Figure 7**. Cold sanitary water is brought to the over temperature relief valve from group of thermal safety values. When the over temperature relief valve from group of thermal safety values -probe has the information that the temperature is over 95 degrees the over temperature relief valve from group of thermal safety values is opened and water flows through copper coil. After some time the temperature of water in boiler returns to its normal state.
- One connection of coil is used for over temperature relief valve from group of thermal safety values and the other for draining of water that has passed through the coil. The choice of either connection; for over temperature relief valve from group of thermal safety values or for the discharge is irrelevant. It is necessary to follow the installation instructions provided by the manufacturer of the over temperature relief valve from group of thermal safety values.
- Be sure to check up, in certain periods of time, the functioning of the over temperature relief valve from group of thermal safety values.

As stated above one end of the over temperature relief valve from group of thermal safety valves is for the mounting on the exchanger of the boiler, and the other is supplied with cold water under pressure. It is particularly important that the water flow is unobstructed even when the electricity is switched off.



If it is impossible to provide the inflow of cold sanitary water at the time of electricity switch off, the boiler must be connected onto the open system.

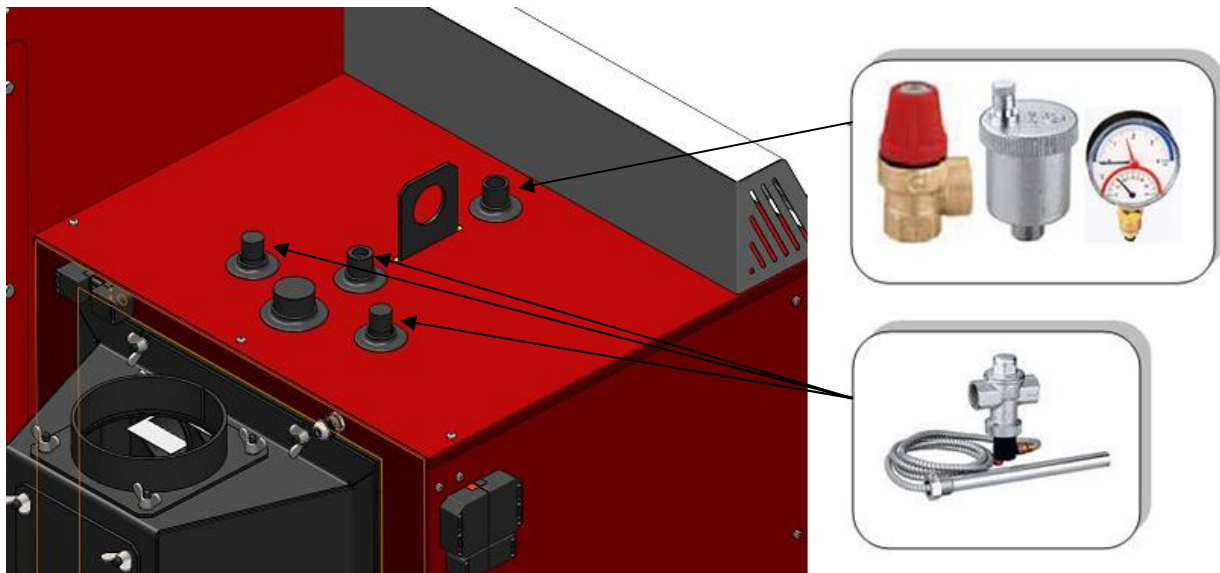

Figure 7. Installation of safety elements

- Thermostats in the automation of the boiler (Figure 8)

Within the automation itself, that leads the combustion process and influences the work of boiler and system of central heating, exists two implemented thermostats. These thermostats are gaining informations, about temperature of water and flue gases, using temperature probes. These thermostats are mainly designed for corect work of boiler,they have some safety functions also but they are not main safety elements.

As safety element thermostat is used as shown on figure 8, and it have function limit temperature of water in boiler, and its independent component. Temperature is limited to 90 degrees of Celsius. STB thermostat is located near display of automation, and its voltaic connected with it.



Installation of the tap for the filling and emptying is committed at the lowest point of the system. Because boiler do not have connection for the filling and emptying, tap should be connected in the lowest point of the return conduit. Installation should be filled slowly so that system would be well aired. After filling of the installation is complete, system should be checked for potential leaks.

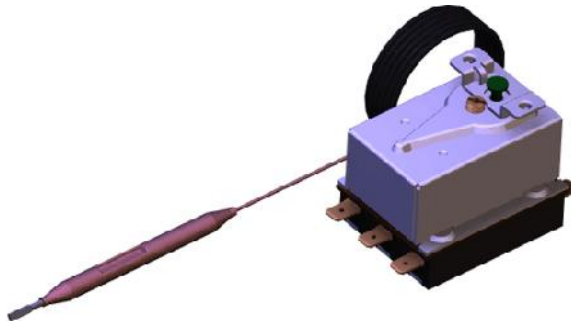

Figure 8

3.3 Boiler room

Boiler room must be secured against freezing.

The support surface of the boiler in the boiler room must be of non-combustible material. Recommended distance of all four sides of the boiler in relation to the boiler walls or other solid body (water heater, etc.) are shown in **figure 9**. These values allow a safe distance access when firing, sufficient space for cleaning and easy access to fan and valve for filling and emptying. Boiler at its left hand side should be away from the wall 200 mm i.e. as much as needed for the connection of valves for thermal safety by over flow. If the valve is not to be installed then the space can be smaller. The flap handle for firing is removable and can be placed either on the left or right side of the boiler. **Boiler room must have sufficient ventilation holes for fresh air as well as for the outlet of the exhaust air.**

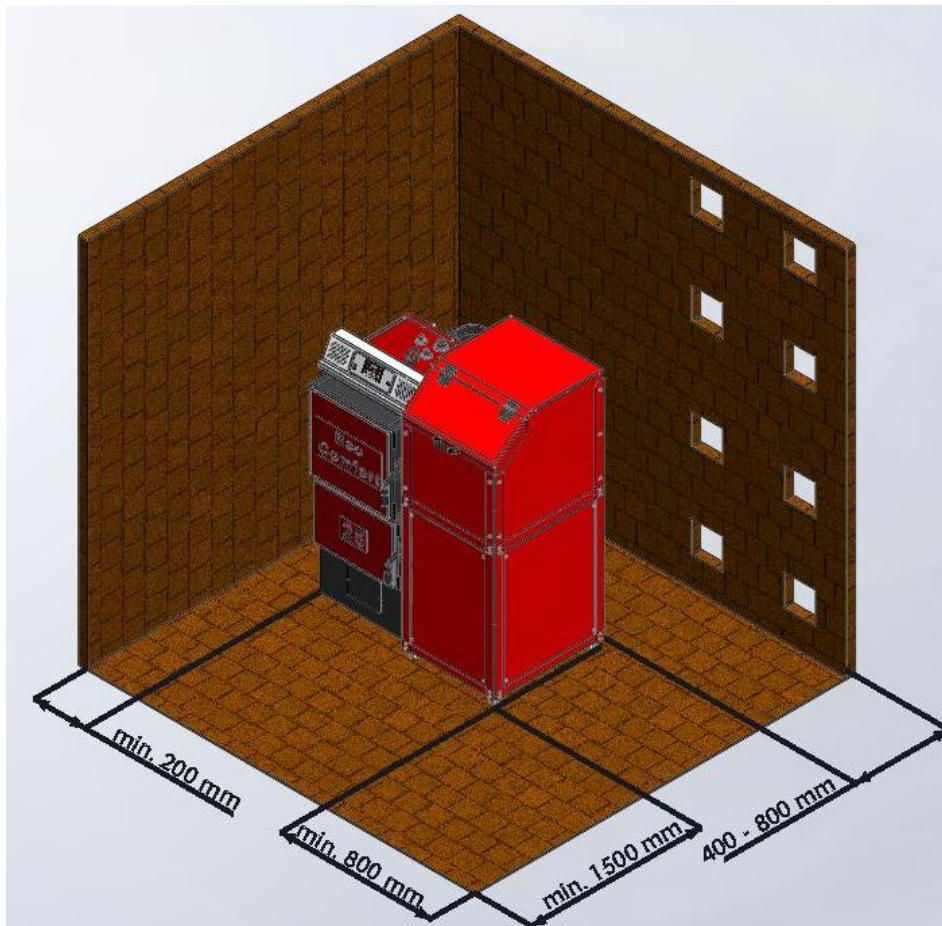

Figure 9. Positioning of boiler in the Boiler room

Total space of this openings is minimum 150cm² fro the boilers of the power of 50kW and for the power over 50kW the space must be larger for another 2cm² per 1kW.

$$A=150\text{cm}^2+\frac{2\text{cm}^2}{\text{kW}}\times(\sum Q_n - 50\text{kW}) \quad \sum Q_n = \text{possible power of over 50kW.}$$

The lack of sufficient ventilation in the boiler room can cause more problems in the work of boiler. Main problem is the inability to achieve high output water temperature i.e. the lack of maximum power which leads to condensation in the boiler.

- Take into account the required minimum space required for access and security elements to carry out cleaning operations.
- Determine whether the degree of electrical protection is in accordance with the characteristics of the room where the boiler will be located.
- No exposure to atmospheric influences. The boiler itself is not anticipated for outdoor use and contains no anti-freeze system.
- It is forbidden to close the vents in the boiler room in which the openings are necessary for proper combustion.

3.4 Connection to the chimney

The boiler ECO COMFORT 25 works on forced draft, but the rules should be respected as if the selection of the chimney were for the boiler working on over-pressure in the combustion chamber some other fuel, like oil fuel, for example. Otherwise the problems may occur in the work, especially in the ignition phase.

It is recommended that the diameter of the chimney is at least equal to the diameter of the flue has, and minimum height of 7 to 8 meters, depending on the coverage of the chimney by some other high buildings next to it.

The most optimal positioning of the boiler onto the flue outlet is such that connecting the center of the exit gases from the boiler flue and chimney connection to the center is slightly raised (up to 3 %) (see **Figure 10a** ans **Figure 10b**).

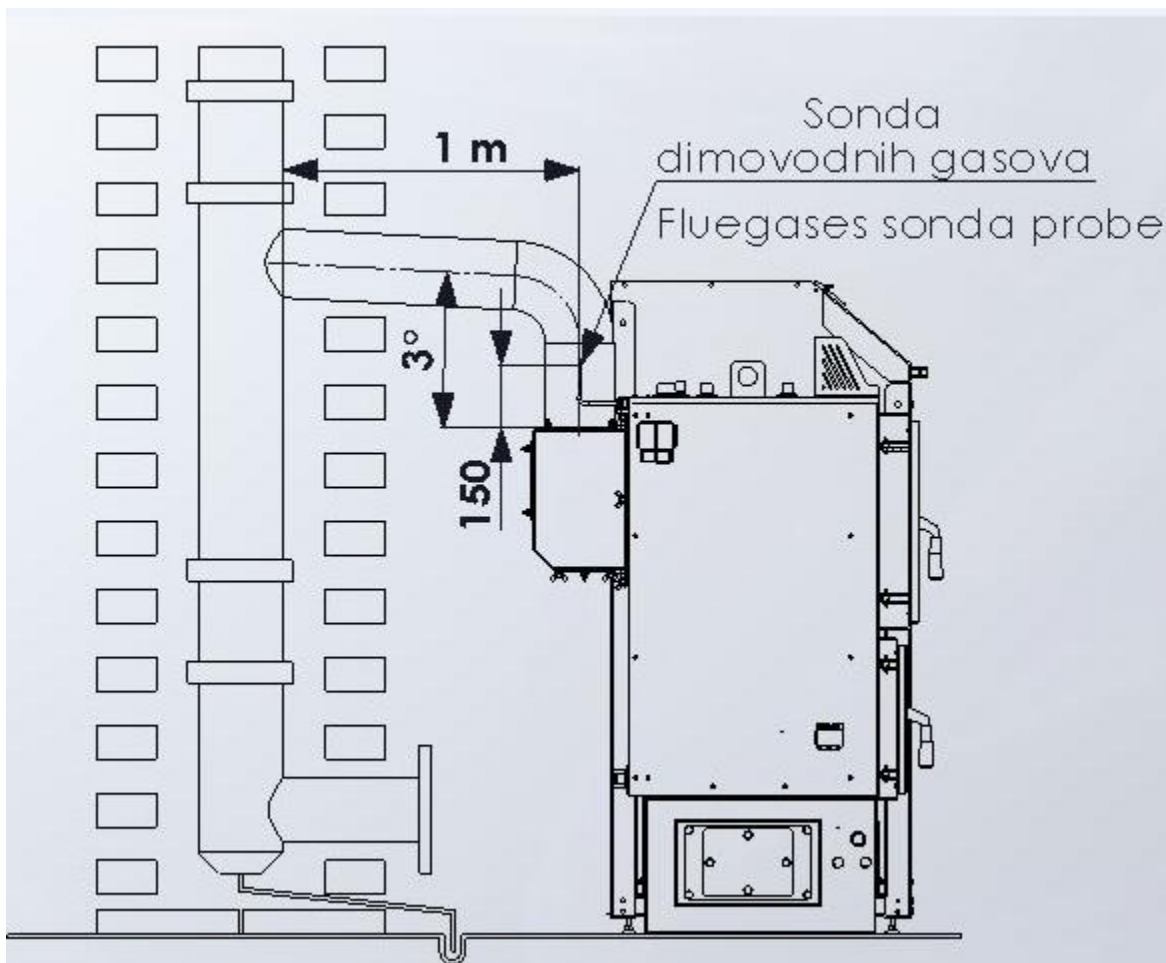
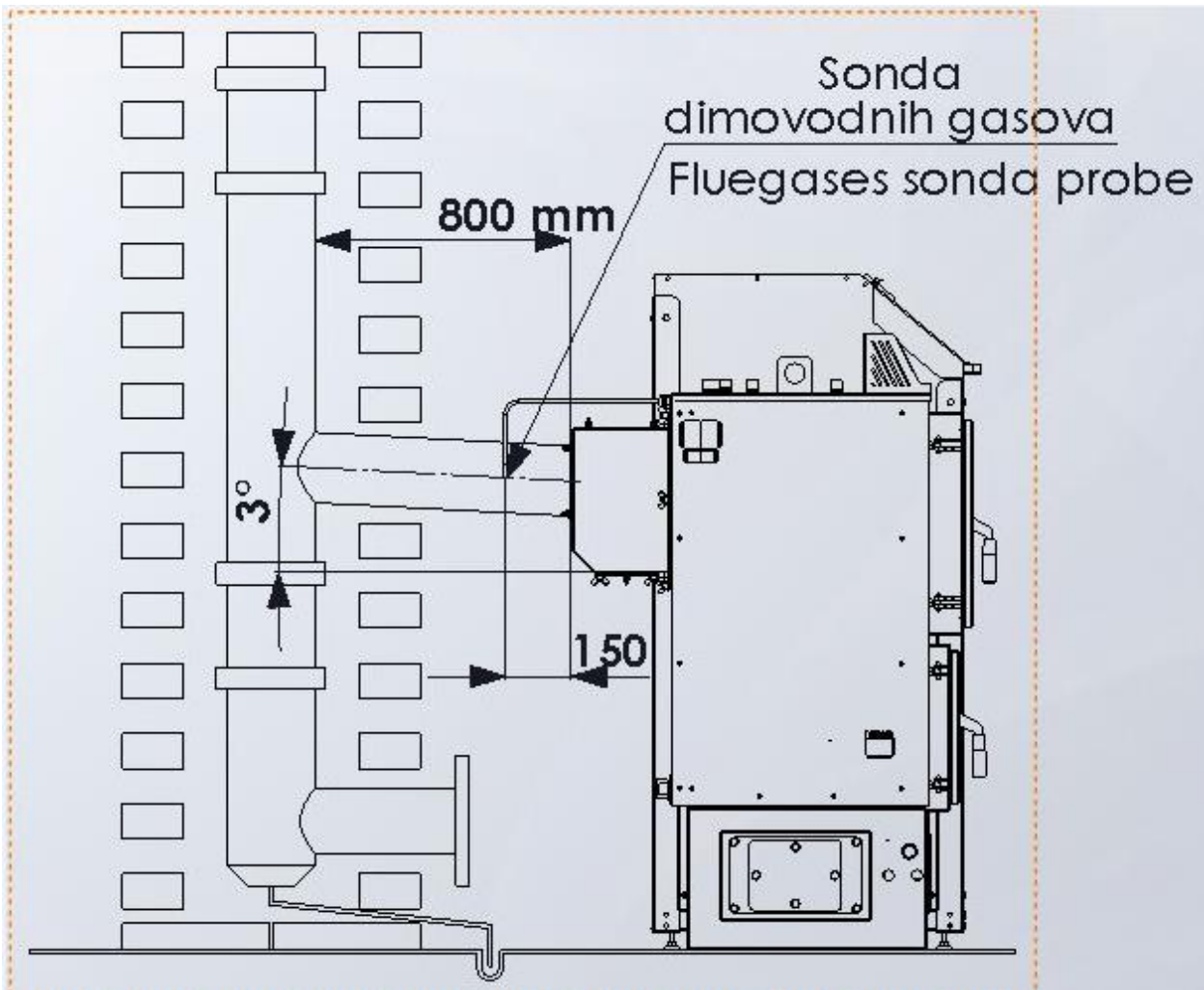

Figure 10. Connection to chimney

If possible, arcs should be avoided, but if not possible, then the maximum number of arcs is 2. The fume channel from the boiler to the chimney, should desirably be insulated, specially if it has arcs and longer sections.

On the smoke pipe, approximately 150mm from the flue outlet from boiler, a hole should be drilled and a temperature gauge should be mounted for flue gas temperature measurements. Without information about the temperature of flue gases there isn't the automatic mode of the boiler.



The chimney itself should be made of ceramic pipes, and around them there should be the insulation of 3- 5cm thickness and the outer layer is of the bricks or special elements. If the chimney is not from ceramic pipes but of bricks, the light opening area of such chimney shall be 30 % higher than the surface of this ceramic pipes chimney. Minimal sectional dimensions of both chimneys and the minimum heights are given in table 1.

The chimney must have a door for cleaning and it must be well sealed. Chimney outlet on the roof must be according to certain regulations. There are two cases: if the angle of the roof is less than 12° and if the roof angle is bigger than 12° . For angle less than 12° the height of the chimney above the roof is 1 m and for the larger than 12° , then look at the sketch.

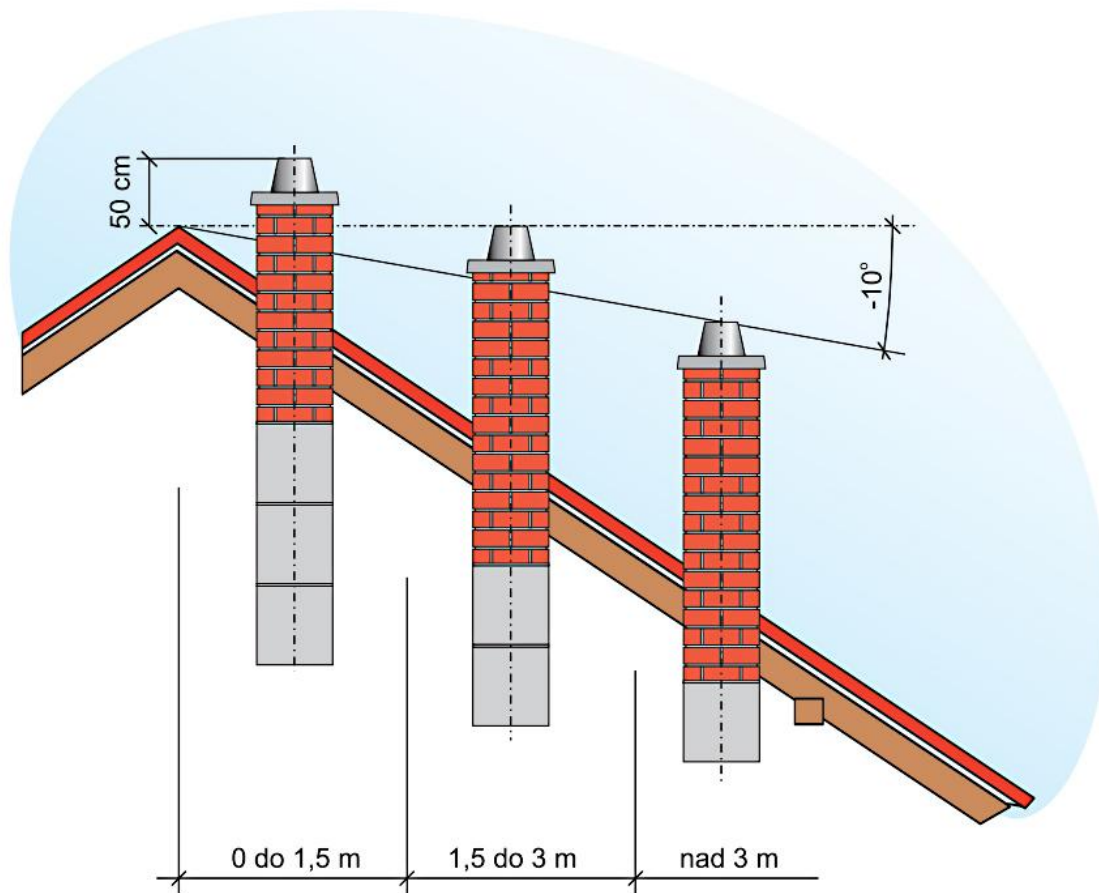

If you think that the chimney is too strong and too much cold air passes through the boiler, there is always an option to procure and install necessary part. The chimney should be cleaned regularly or at least once a year.



If the chimney is not of proper height, cross section, or if it is not enough clean as possible, then the complications in the work of boiler are possible. First, of all it is not possible to achieve the high temperature regime of work, i.e. there is not the maximum operation power, and the consequence of that is the occurrence of condensation which affects the life of the boiler.



Weak/poor chimney is the main reason when during the ignition of the boiler or during the operation there is the appearance of smoke on the upper or lower door, especially at higher fan speeds.

4. Cross-section of ECO COMFORT 25 Boiler with a description of the boiler elements

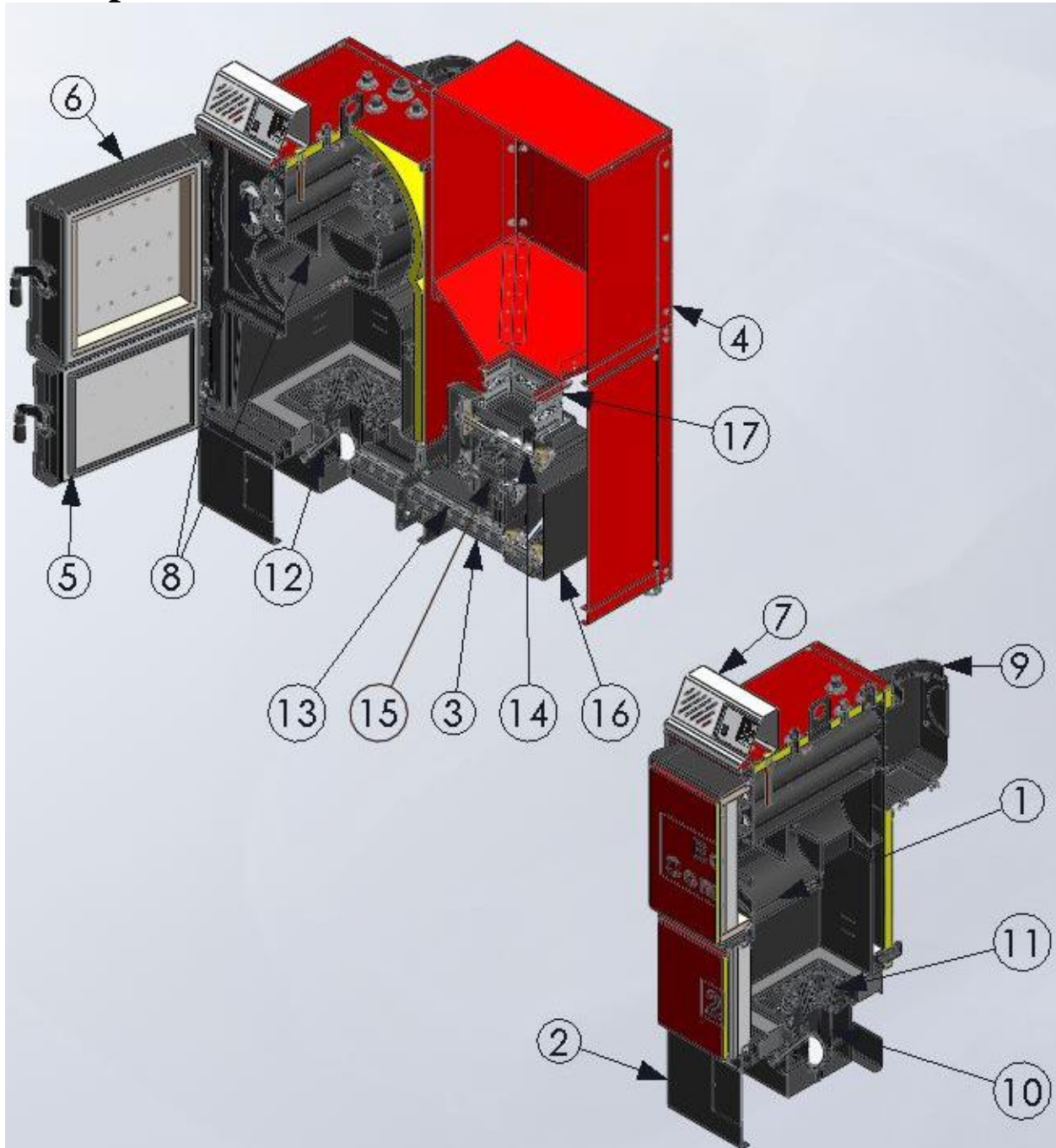

Figure 11. Cross-section of ECO COMFORT

Description:

1. Body of boiler;
2. Combustion chamber;
3. Feeder;
4. Silos;
5. Lower door for ignition and cleaning;
6. Upper door for cleaning;
7. Automatic
8. Turbulators;
9. Chimneys;
10. ;Combustion pellets;
11. Cast iron elements;
12. Ignitioner;
13. Upper screw conveyor;
14. Lower screw conveyor;
15. Rotation safety element
16. Box for chainwheel and bearings;
17. Flexible connection



5. Schematic connection of automation

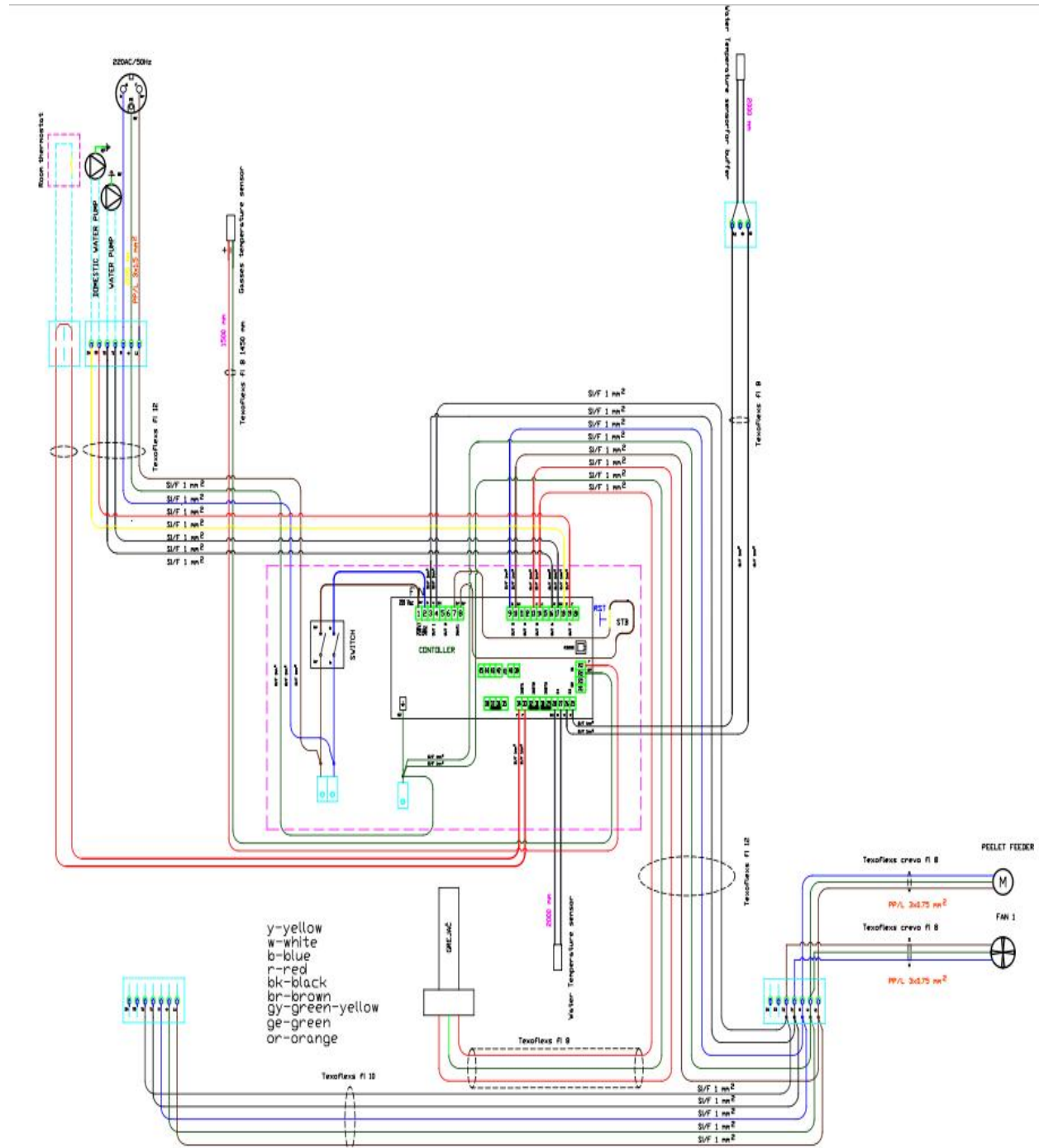

All lines that are displayed in the intermittent form in the diagram of external connections are the conductors which should be installed by the technician when connecting the external devices onto the automation system of the boiler. All the connections of the additional devices are performed by the technician through three connectors located at the rear of the boiler. Two connectors are three-pole connectors while one is seven-pole connector. One three-pole connector serves for the connection of the room thermostat as shown on the label the connector itself.



For the room thermostats it is important to be battery-powered on, i.e. they should not have any supply of the voltage of 220 V. On the thermostat for the connection NC is used (normally closed contact).

Seven-pole connector is for connecting network cable and for the connection of the circulation pump and the battery pump i.e. of the heater for sanitary water.



The boiler can operate even if none of the pumps is connected, but manufacturer's recommendation is that, at least, the pump₁ (central heating pump) because it has the function of a security element. It is switched on when the boiler water temperature exceeds 90°C.

6. Table of technical data

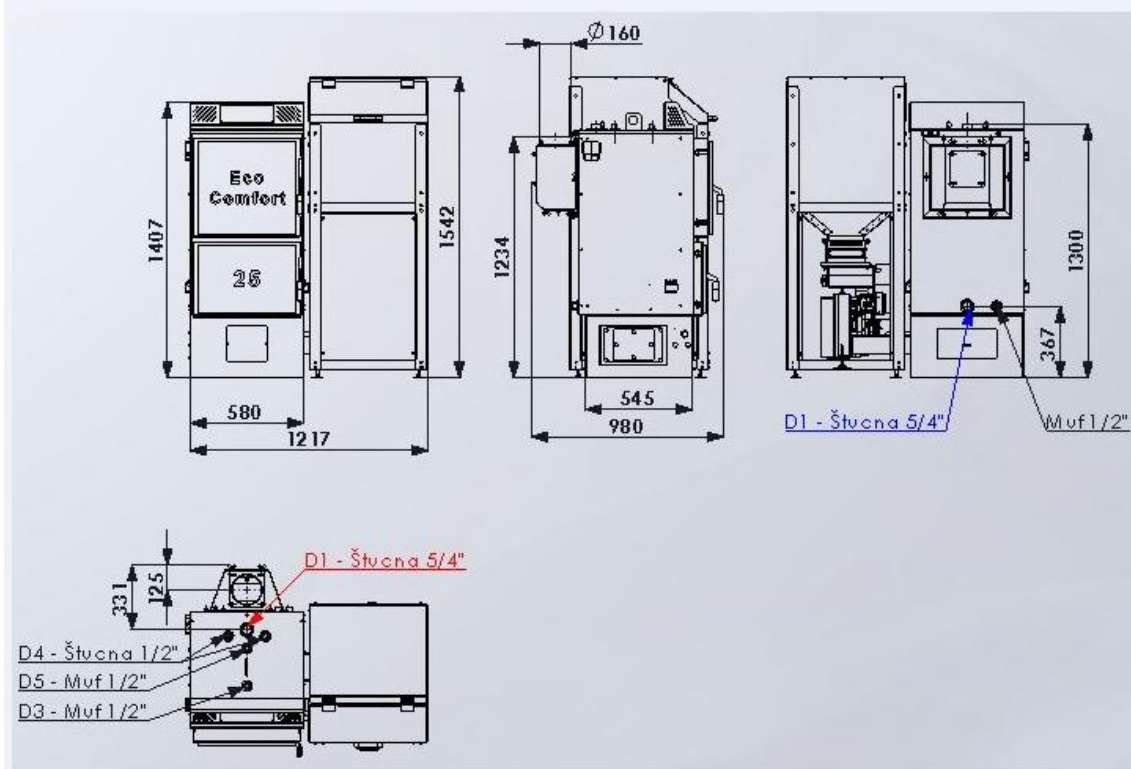
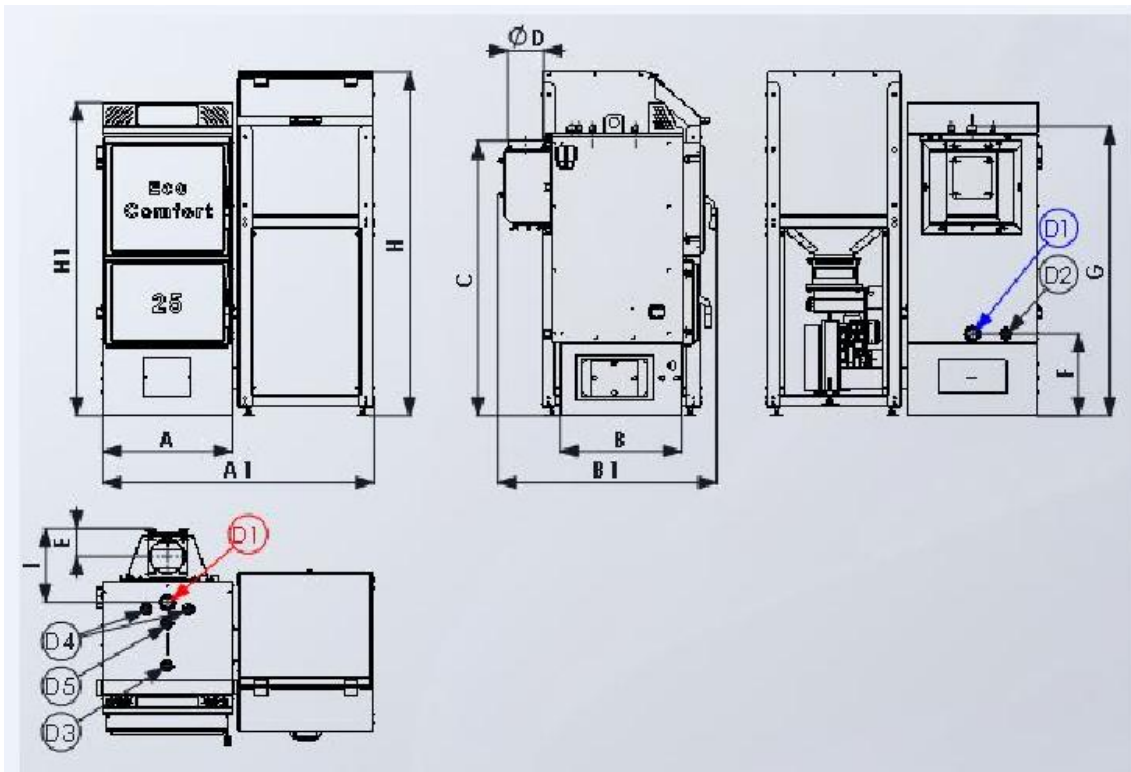

BOILER TYPE		Eco Comfort 25
CE designation		CE
Class of Boiler according to EN 303-5:2012		5
Working Pressure	bar	3
Test Pressure	bar	4,5
Volume of combustion chamber	L	68
Volume of water in the boiler	L	85
Weight	kg	428
Cross section of chimney	mm	160
Necessary chimney draft	mbar/Pa	0,15/15
Boiler temperature (min / max)	°C	60/90
Minimum return temperature	°C	60
Efficiency degree	%	91,96/92,63
Nominal thermal power	(kW)	25,26
Minimum/Maximum Power	(kW)	7,41-25,26
Carbon monoxide (CO) with a nominal thermal input (10%O₂)	(mg/m³)	89,69
Carbon monoxide (CO) with a minimum thermal input (10%O₂)	(mg/m³)	156,38
Dust (nominal/minimum thermal power) (10%O₂)	(mg/m³)	18,01/19,14
Dimensions		
	A	580
	A1	1217
	B	545
	B1	980
	C	1234
	D	160
	E	125
	F	367
	G	1300
	H	1542
	I	231
Connections for hot and cold water boiler from boiler	D1	5/4"
Connections for filling and emptying boiler	D2	1/2"
Connections for the safety valve and vent pressure	D3	1/2"
Connector for thermal valve insurance swelling VTO	D4	1/2"
Connections for probe VTO	D5	1/2"

7. Hydraulic scheme

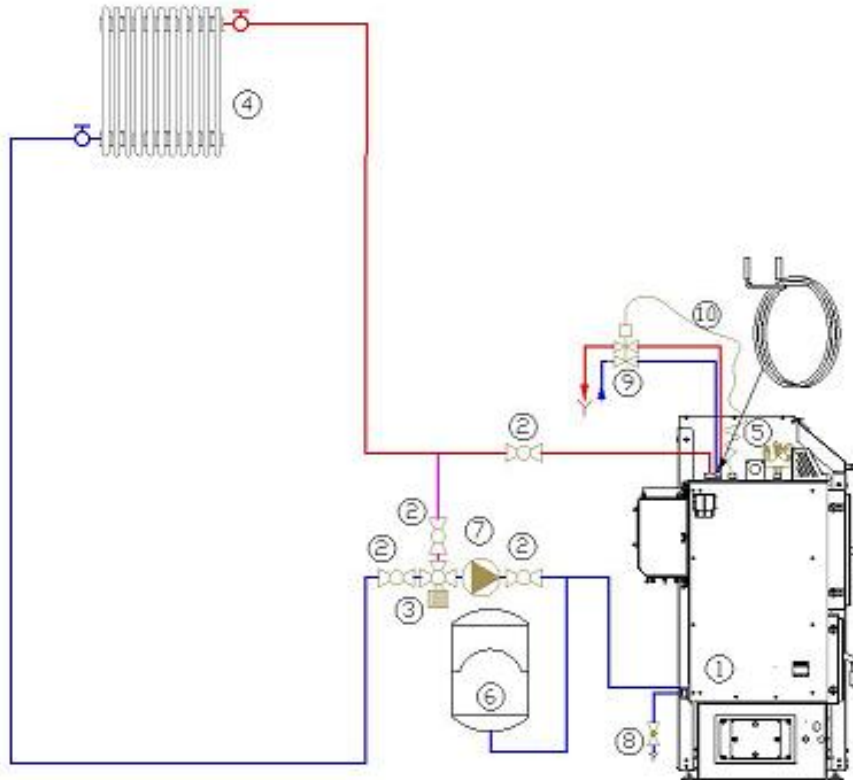

Hydraulic scheme

Description:

1. ECO COMFORT 25 Boiler;
2. Valve;
3. Mixing valve;
4. Heat exchanger;
5. Safety group;
6. Expansive vessel;
7. Pump;
8. Valve for filling/emptying;
9. Over heating temperature safety valve;
10. Probe for safety valve.



In an assembly the boiler should be properly protected against the excessive overpressure and overheating.

 **For the proper installation the plumber/installer is responsible.**

 **The manufacturer (Radijator inzenjering) does not take any responsibility coming from the incorrect installation of the boiler.**

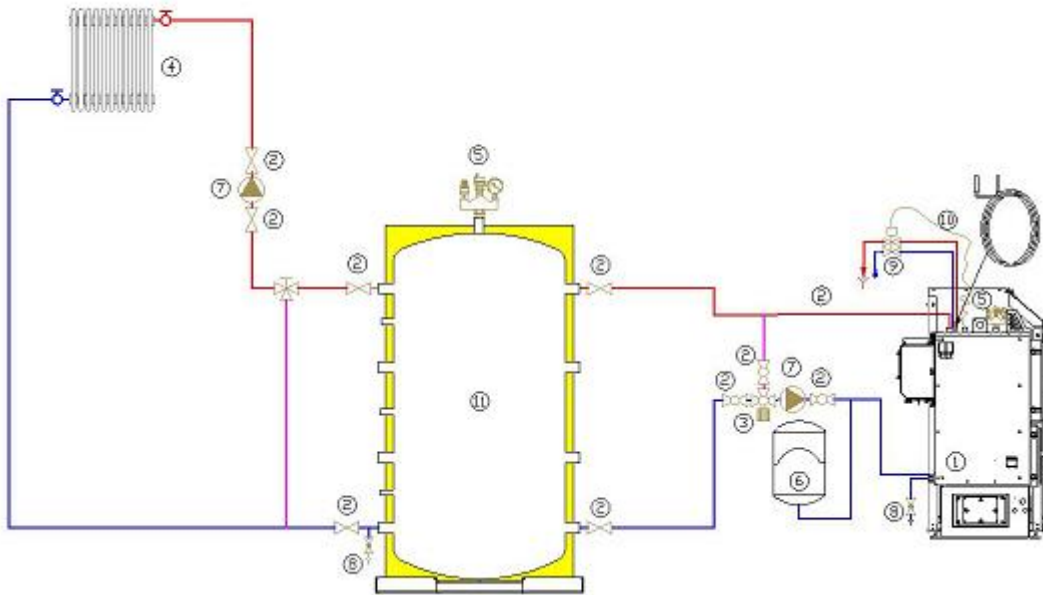

Hydraulic schema with puffer

Discription:

1. ECO COMFORT Boiler;
2. Valves;
3. Mixing valve;
4. Heat exchanger;
5. Safety group;
6. Expansive vessel;
7. Pump;
8. Valve for filling/emptying;
9. Over heating temperature safety valve;
10. Probe fot safety valve;
11. Accumulator tank (puffer)

8. Start of boiler operation and cleaning



First Commissioning of the boiler is performed by a Technician who has a Certificate issued by the “Radiator engineering” Co. Training of boiler users is mandatory.

In this way, the person is authorized to notify the customer service in the factory, time when the boiler started its operation in the condition of the boiler at its first firing, while a copy of the commissioning of the boiler in operation is retained. Guarantee and instruction manual are given to the customer. One copy of Guarantee is sent to the manufacturer.

If the guarantee is not filled in, it is not valid.

Only boilers that are operated only by authorized persons subject to technical conditions of complete guarantee of two years. The following text is intended for the user of the boiler, as a kind of reminder, that if you turn off the boiler (eg for cleaning) will be able to independently run the boiler.



The parameters related to the operation of the boiler and which are available to the user on the display. Other parameters that are called hidden menu should not be changed without the approval of the technical person who has put the boiler into operation or the factory.

8.1 Control board



Control panel consisting of:

The main switch, safety thermostat button, the display, the group command buttons (buttons), a group of light-emitting diode pointer.

The picture below is the image of the Control Panel.



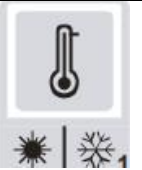
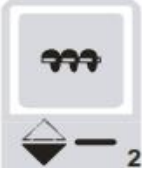







8.1.1 Buttons

Button	Function
	<p>K1</p> <ul style="list-style-type: none"> • With a Click enters to modify the value of the Boiler thermostat: Led L3 blinking: with buttons K2 and K3 modify the actual set value. • A long pressure enters to modify the function Winter/ Summer signalled by the led L1/L2. • In modify parameters saves the set value.
	<p>K2</p> <ul style="list-style-type: none"> • With a Click enters to modify the value of the Working time of the cochlea engine: Led L7 blinking: with buttons K2 and K3 it is possible to modify the actual set value. • A long pressure activates the manual loading of the combustibile for the length of the pressure activating the cochlea engine: the display shows LoAd. The procedure is possible only with state OFF. With a safety valve the loading starts after the timer T72. • In modify parameters it is possible to decrease the value and the sliding of the parameters' codes.
	<p>K3</p> <ul style="list-style-type: none"> • With a Click enters to modify the value of the fan speed: Led L8 blinking: With buttons K2 and K3 it is possible to modify the actual set value. • A long pressure activated the fan at the maximum speed for the length of the pressure. The display shows UEnt. The procedure is possible only with state OFF. • In modify parameters it is possible to increase the value and the sliding of the parameters' codes.
	<p>K4</p> <ul style="list-style-type: none"> • With a long pressure ignites/extinguishes the boiler: Led L5/Led L6 on. • With a click enters the menu visualisation of the temperature values provided by the system. • In modify parameters exits without saving.
<p>K2+K3</p>	<p>K2+K3</p> <p>With a long pressure of both the buttons it is possible to modify the combustion recipe. It is signalled by led L12-L14: with buttons K2 and K3 it is possible to modify the actual value Pr1/Pr2/Pr3. The maximum settable combustion recipes in the user menu is limited to the parameter P89.</p>

NOTE:

In state **OFF** or **EXTINGUISHING**, in case of alarms, pushing the button **K2** or **K3** it is possible to end the Visualisation. If present again after the reset, they are shown again.

8.1.2 Led

Led		Function
	L1	On for selection modality Winter.
	L2	On in modality Summer.
	L3	On for boiler temperature less than A03-A05. Blinking for temperature more than the above thermostats. Off for temperature more than A03.
	L4	On if contact Crono closed.
START	L5	On in State Boiler On.
STOP	L6	On in State Boiler Off.
	L7	On for Auger On.
	L8	On for Combustion Fan On.
	L9	On for Pump 1 On. Blinking for Pump P1 deactivated from Ambient thermostat.
	L10	On for Valve/Pump P2 on.
	L11	On if Contact Ambient thermostat closed.
Pr1	L12	On to choose Program Pellet 1.
Pr2	L13	On to choose Program Pellet 2.
Pr3	L14	On to choose Program Pellet 3.

8.1.3 Display

Display\Temperature\State\Alarms: the 4 digit Display shows the water temperature in the Boiler, the name of the state and the alarms.

Display	State	Display	State
OFF	OFF	Mod	Modulation
Chc	Check Up	MAn	Standby
Acc	Ignition	Sic	Safety
Stb	Stabilisation	SPE	Extinguishing
rEc	Recover Ignition	ALt	Boiler OFF with alarms

Display	State	Display	State
tSic	Error Safety Rearmed thermostat	PELL	Lack of Combustible
CALd	Error Water Over temperature		
AccF	Error no Ignition		
SPAc	Error Accidental Extinguishing		
Sond	Probes out of range		

NOTE:

When supplying with the Main Switch the display shows for 2 seconds the Product Code and the Firmware Version:

Display	Description
St 14	Code for product
Ur 1.0	Firmware Version

8.2 Operation start of boiler on biomass

- Boiler connected to Hydraulic system.
- Drill a hole of 4 mm diameter on the upper side of fume pipe in the zone that is very close to wall outlet of the boiler. (**Figure.12a and Figure 12b**)

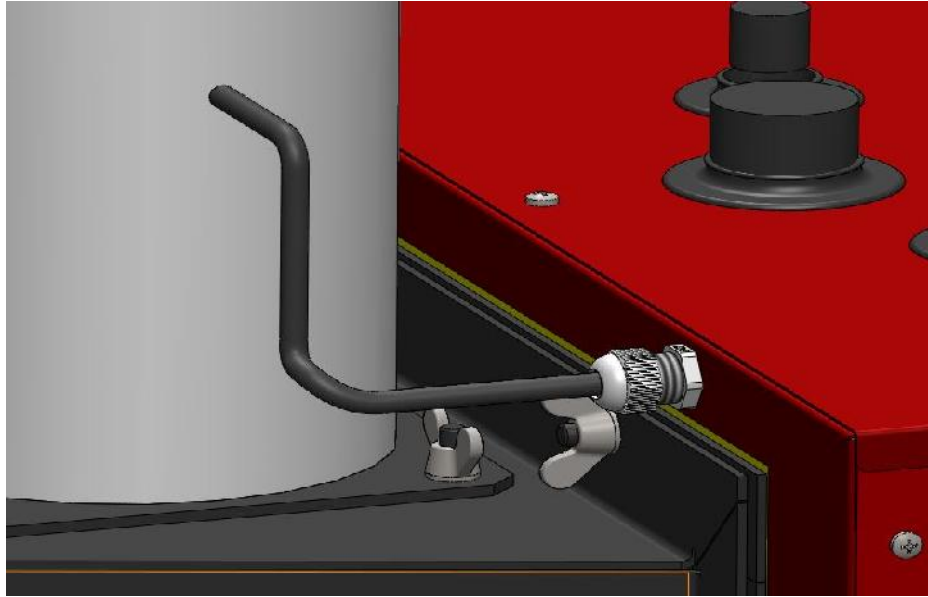

Figure 12a. Placing the probe

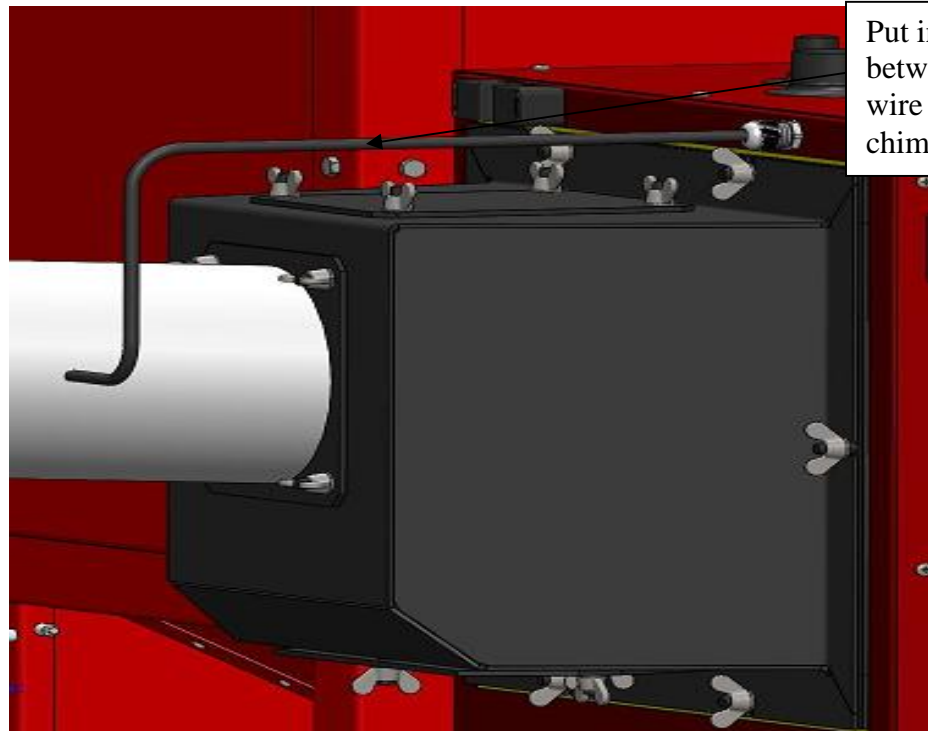

Figure 12b. Placing the probe

- Check whether the mechanism for transport of pellet is firmly supported onto the floor, that the flap of the fan is maximum opened and the flap guide for safety air is from 47 to 49 mm. (Figure.13 and 14)



Figure 13. Position max. open of the fan flap

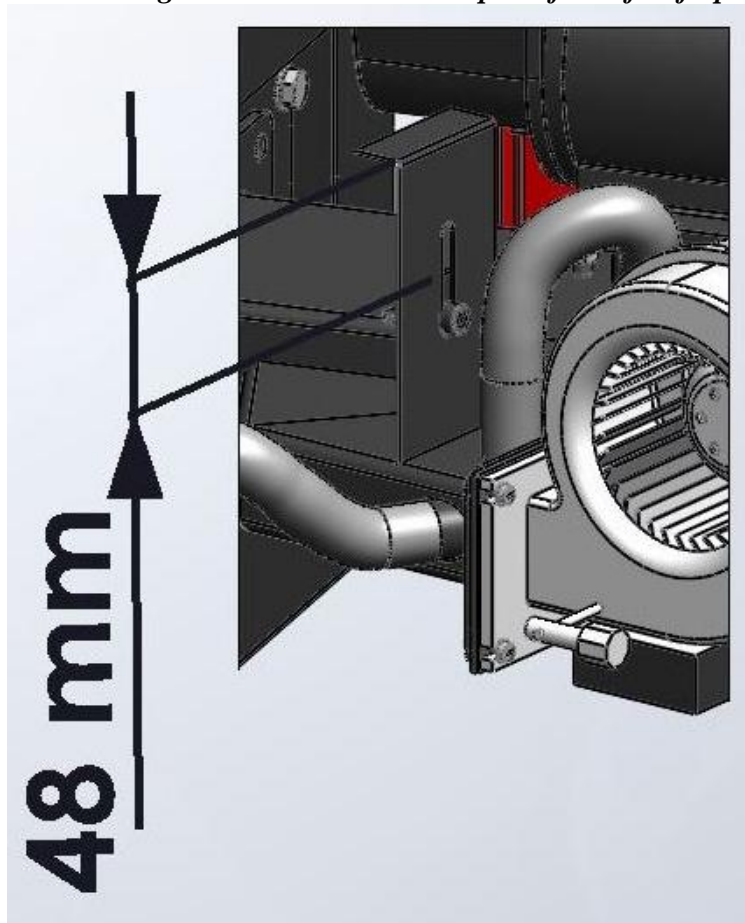

Figure 14. Position of fan flap.

- Power outlet on the back boiler connected to the main power network.
- Infuse a small amount of pellets in the silos and close it.
- At this stage it is necessary to insert the pellets into the combustion chamber by means of the work of the transport mechanism for the pellet (pellet feeding system). In this way we achieve a continuously distributed pellet from the combustion chamber to the silo. The initiation of mechanism for pellet can be achieved only at the stage when on the display it says 'OFF'. Then press the command button 2, which in its lower part has a symbol of the screw conveyor, and the mechanism starts up. As long as we are holding the button pressed the mechanism is in operation. When we release the button the mechanism stops. Loading the pellet into the chamber, by the-so-called manual command is to be performed a little lower, up to the starting position of the parts of grey cast iron, as shown in **Figure 16**.



Figure 16. Level display pellets

- Now that we have the pellets in the combustion chamber and when they are in the zone of the heater for initiation of fire, we can start the operation of the boiler. Start is performed by pressing and holding the command button 4 for more than 3 seconds. On the lower part of this button there is the displayed symbol for the loose material or pellets.

At a time when the boiler goes on with the start of ignition, on the display there is the mark –written as Chc, for the few seconds only the fan is working. During this phase of the automatic system checks whether all devices necessary for the operation are actually connected.

The next step is when the display says Acc. This is the mark for the phase Ignition. Then, beside the fan, the heater for start of firing is switched, which can be seen on the automation display because the signal lights that are glowing are those with the numbers 2 and 7. In the stage ignition, at one time, it should be expected that the system for transportation should be switched and the level of pellets in the chamber

Radijator Inženjering d.o.o, 36000 Kraljevo, Živojina Lazića - Solunca br.6, Srbija
tel. +381 36 399 140, fax. +381 36 399 150, <http://www.radijator.rs>
e-mail: radijator@radijator.rs

should be re-filled. It is ideal, after this re-filling, the pellet should be located up to the beginning of grey cast iron parts.

The boiler is in the ignition phase until the flue gases exceed the temperature that is pre-determined by parameter. According to the factory settings, the temperature is 70. First the smoke appears and during the period from 7 to 10 minutes the flame is starting.

- When the flue gases exceed the limit temperature of the ignition on the display there appears the mark Stb. This means that the boiler flame is in the phase of stabilization, i.e. now the automatic system is measuring whether the flue gases have enough increase for certain time. The fan is working according to the parameter for the stabilization phase, and there is a supplement feed of the pellet in the firing chamber, also in accordance with the parameters of the screw conveyor in the stage stabilization. When this factor is satisfied the boiler goes into operating mode.
- The boiler is in operating mode when the display does not say anything except the current water temperature in the boiler. We should wait 20 to 30 minutes and see if the pellet is burning on the top of the firing chamber. Also, in this period we should monitor what the temperature of flue gases is. It is done by briefly pressing the command button 1 and then button 3, and at the end the button 2. Then on the display appears the number that indicates the temperature of flue gas.

Example of parameters for ECO COMFORT 25 at nominal thermal power. Pellets 4,76 kWh / kg	Example of parameters for ECO COMFORT 25 at minimum thermal power. Pellets 4,76 kWh / kg
Duration of dosing pellets (s) 2,5	Duration of dosing pellets (s) 1
Break between two dosing of pellet (s) 5,6	Break between two feeds of pellet (s) 9,1
Primary speed (%) 27	Primary speed (%) 21
The valve branch taking the air for combustion through the screw conveyor was open 80%. Clap branch that leads on for the inlet of air through the open crucibles was at 48 mm of the line mark on the flap as shown at the figure 14.	The valve branch taking the air for combustion through the screw conveyor was open 80%. Clap branch that leads on for the inlet of air through the open crucibles was at 36 mm of the line mark on the flap.
Efficiency degree (%) 24,96	Efficiency degree (%) 7,44

Burning time:

Maximum heat power:

- Burning time (h) 6
- Amount of heat energy (kWh) 150
- Amount of pellets consumed (kg) 35,62
- Calorific value of pellets consumed (kWh/kg) 4,76

The minimum heating value:

- Burning time (h) 6
- Amount of heat energy (kWh) 45
- Amount of pellets consumed (kg) 10,23
- Calorific value of pellets consumed (kWh/kg) 4,76



NOTE: These are the values measured during certification.

- The room thermocouple (thermostat) can be connected to automation system. In this case, it is important to adjust the room temperature, which is the main parameter for the operation of the boiler and water temperature in boiler (70 °C). When the room thermostat is activated, the boiler has the first need to reach the room temperature, under the condition that it is limited by adjusted degree of water temperature in it. There is a possibility that the boiler stops working before the adjusted temperature of the room thermostat, in this case the set temperature of the water in the boiler should be raised, Example to: 70 °C.
- The combustion of the pellets, regardless of the power at which the boiler is operating, it is necessary to adjust so that in the space at the top of the combustion chamber (**shown in the figure**). This is achieved by adjusting the dosage of pellets and by the amount of air. In the case the level of the flame begins to be lowered, it is necessary to extend the time of dosing or the reduction of the amount of air. If we want to reduce thermal power, it is necessary to reduce the amount of air. If it happens that the level of flame rises, we can reduce the time of loading or increase the amount of air. To accurately determine the parameters it is necessary to monitor the process of operation for at least an hour.

NOTE : Always, nominal or maximum power of burning wood pellets should be observed, i.e. when pellet is burned on top of the burner. In this case, the decrease of the heat power is performed by reducing the set boiler water temperature or set the temperature of the room thermostat.

Place where pellets „dancing“ during combustion

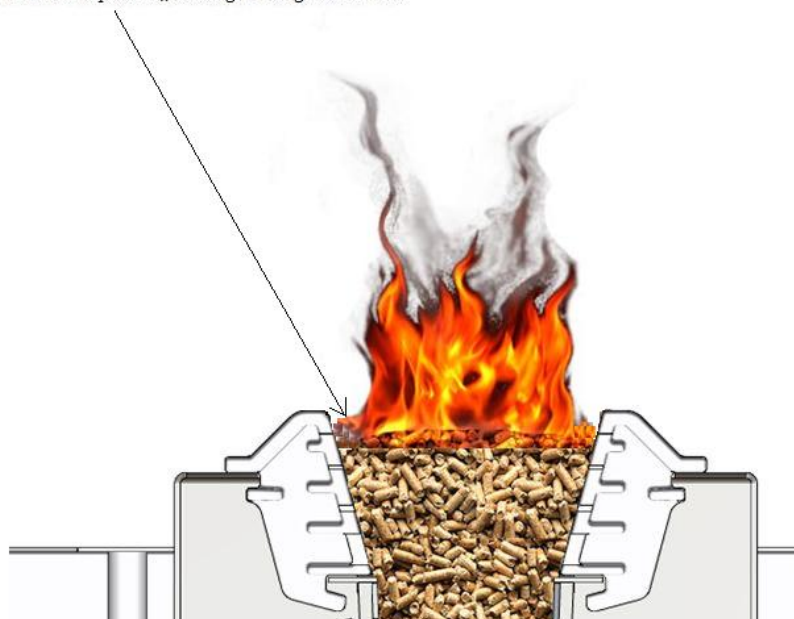

Warning: Be sure to make the analysis of the flue gases after the finish of installation of the boiler. Measure the percentage of oxygen (O₂).

8.3 Short manual for automatic control

8.3.1 Re-LOADING FIREBOX WITH PELLETS, PREPARATION OF STARTING.

- Infuse pellets in a silos.
- The main display must write **OFF**



- Push the button and keep . As long as we keep working conveyor button and the display says **LOAD PELLETS**.

8.3.2 START IGNITION PELLETS, STOP WORKING ON PELET.

- Turn the main switch.



- Push the button  ⁴ and keep it in that position for 4-5 seconds.



- Break of operation of pellet boiler is done by pressing the button  ⁴ and keeping for 5 seconds.

8.3.3 CHANGING FEEDING SYSTEM TIME ON OPERATING MODE.



Push one short ,

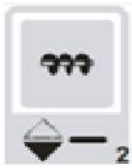

with  ² and  ³ change value of feeding system.

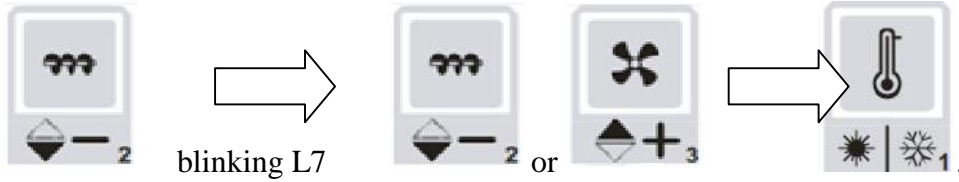

8.3.4 CHANGE IN VOLUME FAN OPERATING MODE.

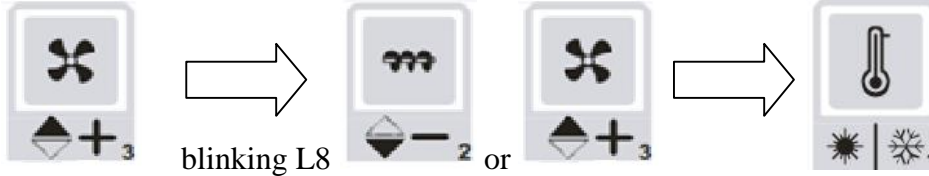

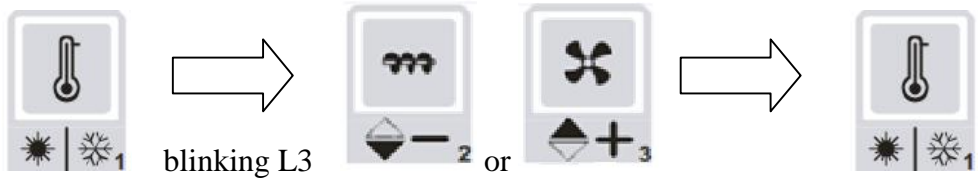

8.3.5 CHANGE THE SET TEMPERATURE IN THE BOILER.

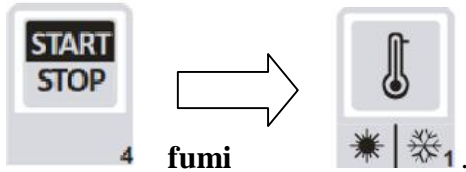

8.3.6 HOW TO READ THE TEMPERATURE OF FLUE GASES.



8.3.7 ENTRY INTO THE HIDDEN MENU.

Push  and  and keep both buttons 5 seconds. Immediately after entering in „hide“ MENI on display write **CL 00**. That is first parameter.

8.4 Mistakes during ignition and start of the boiler

All possible mistakes in the initial phase of operation, i.e. during the ignition, can be divided into three major groups:

- **Group I** . Mistakes in the ignition relating to the situation when there is not an occurrence of sparks, smoke or any flames for longer than 20 minutes from the moment you turned on the heater for ignition.
- **Group II** . Mistakes in the ignition related to the situation in the event the flame occurred, but the boiler after some time (a few minutes later) was extinguished.
- **Group III** . Boiler was successfully ignited and worked for several hours. It reached the set temperature , and for a long time there is no need to switch on either the fan or dosing system (usually this situation is during the night). Then the temperature drops or the user wants a higher temperature. (usually in the morning) and the boiler receives a signal to start the ignition phase, but the flame is out.

Group I

Possible **cause 1**.

- **CAUSE 1** – Closed fan flap for primary air. The fan is positioned on the dispenser.
- The procedure for **troubleshooting 1** – Open the fan flap at maximum.

Possible **cause 2**.

- **CAUSE 2** – The hose that connects the channel of the air from the fan to the heater is not properly set.
- The procedure for **troubleshooting 2** – Attach the air hose both onto the heater casing and the air duct

Possible **cause 3**

- **CAUSE 3** – The space between the heater and the pipe casing in which the screwed heater is clogged with tar and ashes so there is no air infiltration.
- The procedure for **troubleshooting 3** – Clean this area, first only try from the side inside the combustion chamber with the wire of the thickness 1-2 mm. If this fails switch off the boiler from the mains, now unscrew the heater and clean up the area in which it is located.

Possible **cause 4**

- **CAUSE 4** – Deep area of the combustion space where the pellets are burning is full of unburnt residues, i.e. of the slag so that there is no contact of pellets and hot air.
- The procedure for **troubleshooting 4** – Clean the deep area of the combustion chamber, first clean the rough particles of slag mechanically and the fine slag can be removed by means of vacuum cleaner.

Possible **cause 5**

- **CAUSE 5** – Pellets used are of high humidity.
- The procedure for **troubleshooting 5** – Try to use pellet that has a higher level of dryness.

Possible **cause 6**

- **CAUSE 6** – Electric supply voltage onto which the boiler is connected is much lower than 220-230V so the capacity of the heater is lower.
- The procedure for **troubleshooting 6** – Connect the AC Voltage adapter or ignite manually.

Possible **cause 7**

- **CAUSE 7** – After the manual setting and automatic addition in the ignition area the pellet level is such that the pellet is not in contact with the heater.
- The procedure for **troubleshooting 7** – Re-charge the level of pellets.

Possible **cause 8**

- **CAUSE 8** – The boiler is set from automatic to manual mode of operation. If, along the whole phase of ignition, the heater lamp is not lighted, then we are sure that the boiler is in manual mode.
- The procedure for **troubleshooting 8** – Switch the boiler into automatic ignition.

Possible **cause 9**

- **CAUSE 9** – Faulty electric heater for ignition. Switch off the boiler from the mains supply and on the the electrical heater cords measure the resistance.
- The procedure for **troubleshooting 9** – Change electric heater.

Group II

Possible **cause 1.**

- **CAUSE 1** – Fan speed in the phase of ignition. The speed of fan for primary air at this stage is determined by the parameters and Uc00 and Uc01. If the speed is drastically changed compared to the factory default adjustment it is not good nor is it significant to reduce or or to increase it. In case when the fan, in the phase of ignition, is weak, then there is no increase in temperature of flue gases, but if it is too strong it can cause the rapid consumption of pellets in the chamber, which in turn leads to a reduction in temperature of flue gases in the ignition.
- The procedure for **troubleshooting 2** – Adjust values of parameters Uc00 and Uc01 the factory default or close to the factory default values.

Possible **cause 2**

- **CAUSE 2** – Fan speed in the flame stabilization phase. The boiler enters the ignition and the smoke appears, on the display it says Stb, which means that it is in the flame stabilization phase, but after that the boiler goes out. The most frequent cause for this is too weak fan in the stabilization phase which is adjusted by means of parameter UC04.
- The procedure for **troubleshooting 3** – Increase the fan speed by means of the parameter UC04.

Possible **cause 3**

- **CAUSE 3** – Too much or too little pellets in the phase of stabilization. If there is too many or too little pellets, while on the display it says – Stb – i.e. the stabilization, this may cause the blocking of flame and restoring the boiler into the state extinguishing. The quantity of pellets in the stabilization phase is regulated by means of parameter CL04.
- The procedure for **troubleshooting 4** – Set the value of the parameter CL04 to factory default or close to factory adjustment.

Possible **cause 4**

- **CAUSE 4** – The boiler has entered the phase of stabilization but it is going into the extinction phase because there is not a sufficient increase in temperature of flue gases. Specifically there is the stagnation, i.e. a slight decrease of temperature of flue gases which is visible when re-filling of pellets is done into the furnace.
- The procedure for **troubleshooting 5** – Raise the temperature of flue gases to enter the system of the parameter F18. This way new pellet entering the combustion chamber lowers the temperature of flue gases in a more harder way as the flame is stronger because it had more time until the re-filling of fuel. This problem most frequently occurs when the chimneys are poor in construction or the drought from any other reason is weak.

Group III

Introduction

When the boiler reaches the set temperature of the water in it, or the air in the room, where the room thermostat, turns into a resting phase keeping the flame or, originally said „Standby phase“. best example for this type of boiler is its operation at night.

The main objective of this phase is to maintain the flame or live coals in the firebox during several hours of standby. It is achieved through periodic turning of both the pellet conveyor and fan in certain periods of time.

- At the time when the boiler has reached the set temperature it enters the phase of flame maintenance. After a certain period of time, as determined by the parameter T04 (in minutes) the conveyor starts and fans are activated. During this period it comes to activating of the boiler until it receives the command to start due to the achieved temperature.
- The duration of the process of conveyor and fan operations is determined by the parameter t05 (in seconds).
- During the process of the start of conveyor operation, its work is determined by period as determined by the parameter CL09 (in seconds)
- During the process of maintaining the flames the fan for primary combustion is switched on with the power which determined by the parameter Uc09.

Possible mistakes in the work related to the maintenance phase of the flame:

- Boiler operation, beside the functioning of the phase of flame maintenance, does not have enough pellets for the start and work in normal mode.
- Eliminating the cause of mistake:
 1. Reduce the parameter t04, i.e. increase the frequency of conveyor and fan work in the phase of idle work.
 2. Increase the duration of the process time, ie. The parameter t05.
- Too much of unburnt pellet when boiler starting its work.
- Eliminating the cause of mistake:
 1. Increase the parameter t04
 2. Reduce the parameter t05
 3. Reduce the fan power for the primary combustion in the maintenance phase – the parameter Uc09.

8.5 Maintenance of boiler

ECO COMFORT boiler requires daily and periodic cleaning.

- Daily cleaning refers to the area of the firebox of cast iron where by continuous ash ejection provides a better electric heaters work, a better pellet burning, i.e. a bigger amount of air through air channels in the gray casting. But even during the day the ash begins to accumulate on the floor, and the space around the furnace. The average parameter of 100kg of pellets produce 1 KG of ashes in combustion process.
- In every 3 to 7 days it is necessary to clean the space between the pipe grid for solid fuel. Also it is necessary to clean the deposits on the walls of the firebox. By this we provide a better transfer as one millimeter layer of tar and soot decreases the conductivity by 5%.
- Once in a month it is necessary to open the top cover for cleaning, remove the turbulators and then from the whole area of the boiler the tar and soot should be removed (**figure 18.**). All that is removed in this way, can be collected and taken away through lower openings.

If, during the cleaning in the boiler there appears the condensation it is necessary to collect the condensed matter and the whole boiler inside should be coated by base means for cleaning or else by means of water solution of construction lime. In this way the neutralization of acids is carried out due to condensation.



While maintaining and servicing the boiler, the boiler is to be switched off the power supply.

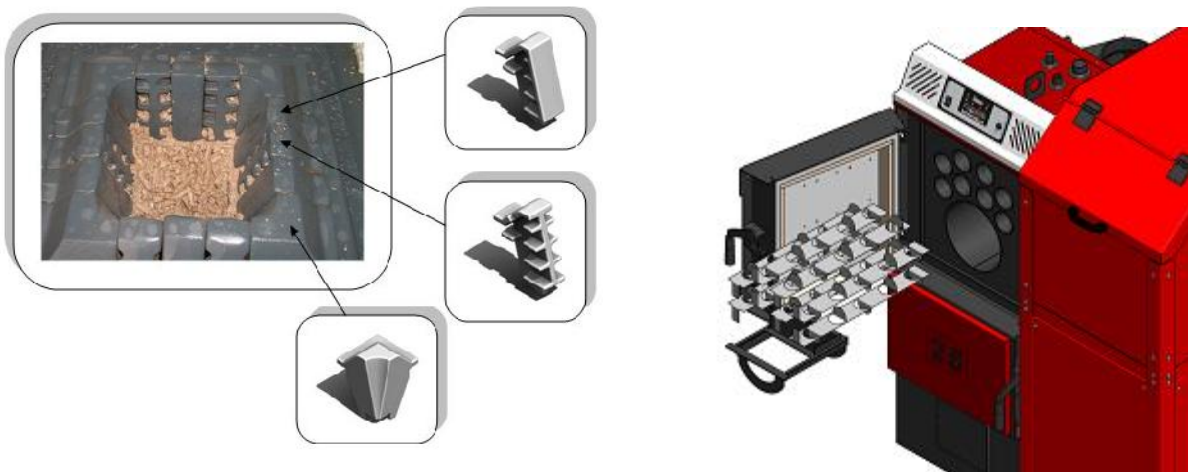



Figure 18. Display removing turbulators from boiler ECO COMFORT

 *In this way the boiler is conserved at the end of the heating season. In this situation, close all openings of the boiler to prevent the circulation of air through the boiler as the moisture can occur in the boiler as well.*

 *Maintenance of the boiler is one of the most essential factors for the length of working life of the boiler. It is particularly important that the boiler be cleaned when out of operation season and neutralization of acids be done as already described.*

8.6 Nameplate

The nameplate is stuck on a well visible place on the boiler and includes the following (see the image in the item: STICKERS):

1. Technical data on sticker:

- Manufacturer (Radijator inženjering)
- Serial number of boiler (primer: N°:120106002)
- Year of product (primer: 2016)
- Type of boiler (ECO COMFORT 25)
- Nominal power of boiler (ECO COMFORT 25 – 25,26kW)
- Heat output range (ECO COMFORT 25– 7,41-25,26 kW)
- Necessary chimney draft (15Pa)
- Electric density (230V)
- Frequency (50Hz)
- Current (3,04A)
- Nominal electrical power (500W)
- Max.extended el.power (200W)
- All.el.power (700W)
- Weight boiler (ECO COMFORT 25-428kg)
- Class boiler (C1)
- Max. pressure (3 bar)
- Max. temperature (90°C)
- Quantity of water in boiler (ECO COMFORT 25 – 85L)
- Class fuel - pellets (C1)

2. Sticker of importer

3. OEEO

4. Other markings on the boiler



8.8 Declaration



DECLARATION OF CONFORMITY

UNDER THE DIRECTIVE 2006/42/EC ON MACHINERY
ANNEX II, PART 1, SECTION A.

On behalf of "RADIJATOR Inženjering" d.o.o./ Živojina Lazića Solunca 6; 36000
Kraljevo; Serbia

DECLARES

Own responsibility: Heating boiler burning pellet production series ECO COMFORT
with rated heating output:
Eco Comfort 25 - 25,26kW; Eco Comfort 45 - 44,18kW.

meet the requirements of: DIRECTIVE 2006/42/EC ON MACHINERY (EFFECTIVE
29/06/2006),

and the requirements of the following directives and regulations:

1. Directive 2004/108/EC of the European Parliament and of the Council of 15 December 2004 on the approximation of the laws of the Member States relating to electromagnetic compatibility (Text with EEA relevance) and repealing Directive 89/336/EEC;
2. Directive 2006/95/EC of the European Parliament and of the Council of 12 December 2006 on the harmonisation of the laws of Member States relating to electrical equipment designed for use within certain voltage limits (codified version) (Text with EEA relevance) and repealed Directive 73/23/EEC.

The machine complies with the following EU introduced harmonized standards:
EN 303-5:2012,

and the following EN and technical requirements: EN 60730-1.

Location: Kraljevo
Date: 2015-07-01



Signature: _____
Miroslav Janić, general manager /

8.9 Sticker

On the boiler Eco Comfort 25 there are stickers identifying the connections as well as labels against the risk of electric shock, stickers for scheme of connections etc.

Labels that indicate connection to the installation:

1. Sticker (Hot water) 32mm x 74mm



2. Sticker (Cold water) 32mm x 74mm



3. Sticker (Safety group) 32mm x 74mm



4. Sticker (Cold water inlet/outlet) 32mm x 74mm



5. Sticker (inlet/outlet of thermal safety relief valve) 32mm x 74mm



6. Sticker (Probe of temperature safety relief valve) 32mm x 74mm



8. Sticker (Hydraulic scheme) 152mm x 210mm

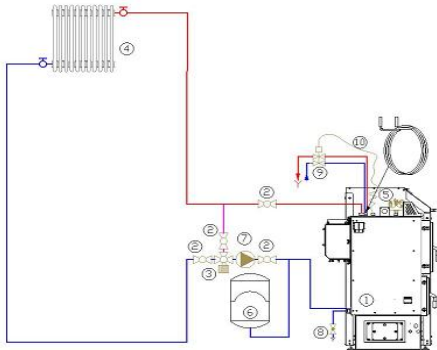

Labels that indicate the presence of electricity high voltage and danger:

1. Sticker (Hazardous voltage) 60mm x 80mm



2. Sticker (Input with low voltage 12V) 60mm x 80mm



3. Sticker (Hazardous voltage - BIGGER) 100mm x 150mm



4. Sticker (Safety electrical connection) 20mm x 30mm



5. Sticker (Presence of voltage)



Labels that indicate warning:

1. Sticker (Exposed moving parts can cause severe injury) 30mm x 80mm



2. Sticker (Only an approved installer is authorized to start boiler)
65mm x 247mm



3. Sticker (Warning)



5. Sticker (Waste)



Labels with technical data:



Živojina Lazića Solunca br.6
Grdica-36000 Kraljevo
Srbija

N^o 120116002

Eco Comfort 25

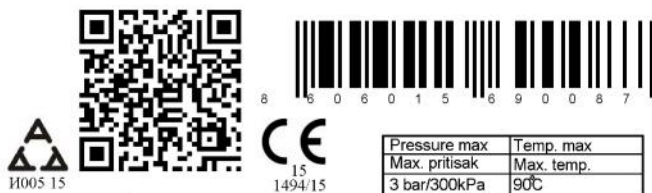

Živojina Lazića Solunca br.6
Grdica-36000 Kraljevo, Srbija
e-mail: radijator@radijator.rs
www.radijator.rs

Pressure max	Temp. max
Max. pritisak	Max. temp.
3 bar/300kPa	90°C

N^o: 120116002

Godina/Year: 2016

Radijator Inženjering

Eco Comfort 25

25.26 kW

7.41 - 25.26 kW

15Pa

230 V

50 Hz

3.04 A

500 W

200 W

700 W

428 Kg

85 L

5

C1

Radijator Inženjering d.o.o, 36000 Kraljevo, Živojina Lazića - Solunca br.6, Srbija
tel. +381 36 399 140, fax. +381 36 399 150, http://www.radijator.rs
e-mail: radijator@radijator.rs



8.10 Manufactured



RADIJATOR D.O.O.
Živojina Lazi a Solunca br.6
36000 Kraljevo, Srbija

Radijator Inženjering d.o.o, 36000 Kraljevo, Živojina Lazi a - Solunca br.6, Srbija
tel. +381 36 399 140, fax. +381 36 399 150, <http://www.radijator.rs>
e-mail: radijator@radijator.rs

9. Warranty

1. Co.”Radiator Engineering” covers different warranty periods for different parts (as specified further on) only if the following conditions of guarantee are fulfilled:

- 1.1. The boiler must be connected to the aforementioned hydraulic schemes of technical instruction , especially pay attention to the safety valves, thermal fuse swelling, mixing valve for protection of the cold portion of boiler or against condensation, the range of work pressure of boiler, r operating temperature of the boiler, the conditions in the boiler room, etc.(see item 7)
- 1.2. The boiler must be connected to the chimney of prescribed cross-section, characteristics of insulation and height. (see item 3.4)
- 1.3. Flue gas outlet from boiler to the chimney must be constructed according to the technical instructions.
- 1.4. The said electrical connections must be done on the boiler according to the technical instructions, particularly this refers to the characteristics of the room thermostat, the characteristics of the power supply, which must be within certain limits.
- 1.5. The user must follow the following instructions on how to use and maintain the boiler. (see item 8)

2. Warranty statement

We herewith declare:

- the product has the prescribed and declared quality properties . We are committed, we will, on the request of the buyer, if he timely submits the Request for the repair within the warranty period, do at any expense all repairs, so that the product will operate in accordance with the declared properties,
- that the product is will operate flawlessly within the warranty period if the instructions for the use, installation and operation are respected,
- that in the warranty period will be ready to remove all product failures and keep in stock all the necessary spare parts,
- **warranty period starts from the DATED OF PURCHASE AND LASTS FOR 60 or 72 MONTHS, from the date of manufacture (the date of manufacture is located on the label on the back of the boiler),**
- **60 MONTHS WARRANTY VALID ONLY IF THE BOILER service regularly by the central service “RADIJATOR INŽINJERING”, within the period specified for the same (in text below),**
- **warranty is valid if the warranty card is stamped by the Seller, with the registered date of purchase and the attached Sale Invoice/Bill. IT IS ALSO IMPORTANT TO HAVE THE ORDER FOR COMMISSIONING (certified by the Service).**

Radijator Inženjering d.o.o, 36000 Kraljevo, Živojina Lazi a - Solunca br.6, Srbija
tel. +381 36 399 140, fax. +381 36 399 150, <http://www.radijator.rs>
e-mail: radijator@radijator.rs

3. The Guarantee period of one year applies to the following parts:

- all bearings of the series UCFL,
- electric heaters firing,
- bearings of the cellular security conveyor (valvole),

4. Warranty period of two years applies to the following parts:

- motor gearbox,
- chains fortorque transmission 083,
- lower worm spiral,
- primary air fan,
- secondary air fan,
- probes for flue gases,
- the probe for temperature of boiler water.
- boiler automation system with safety thermostat,
- segments for combustion of cast iron,
- electrical connectors,
- insulating materials on doors and openings for cleaning,
- parts of cellular security conveyor (valvole) which are made of gray and ductile iron castings.

5. Warranty period does not apply:

- if after each heating season the regular servicing is not performed,
- the replacement of parts in the regular annual maintenance in accordance with the instructions,
- when failures are made by the purchaser due to improper handling of the product,
- with mechanical failures made during transport and during use (solid objects),
- if the product is installed improperly, contrary to the regulations in force in that area,
- if it is determined that the hydraulic scheme is not done according to the recommendations of the "Radijator inženjering",
- if the customer was using the product over the declared properties in normal circumstances.

6. Warranty period expires:

- if it is determined that the defects were removed by the unauthorized persons or unauthorized service,
- if at repair the original parts were not built in,
- when the warranty period expires.

7. When Reporting failures it is necessary to give the following information:

- name and type of product,
- the date of purchase,
- factory or workshop of the fireplace,
- A brief description of the fault, or lack of,
- full address of owner and contact telephone number, e-mail.

8. Regular annual service

Regular service is performed at the end of the heating season in the period from 15.4. to 31.8 and charged by the established price list of the Co. " Radiator Engineering". Service procedure by the technical persons performing regular annual service, which are authorized by the manufacturer for this, including the following operations:



NOTE: The Service Provider is in obligation to inspect all of the following parts (from the list) feeder and exchanger, and if it comes to replacing of any parts of the same, the user receives the above-mentioned warranty and guarantee for another 12 months placed on the body of the boiler (exchanger). The warranty can be extended up to 5 years from the date of commissioning. Service and extension of service can be performed by a person sent by the Central Service of the Co. "Radiator engineering ". For not changed parts, after the servicing work, the service guarantee is not valid.

- dismantling silos pellet from pellet conveyor;
- dismantling of pellet conveyor from the boiler;
- disassembly of both chains;
- removal of the segments for the combustion from the furnace and furnace space cleaning beneath segments. Checking of the state of segments and their mutual gap;
- cleaning the space of the tube in furnace in which the lower worm spiral is rotating;
- Lubricating of all bearings, top and bottom screw shaft and checking of their proper operational state. Bearing must not have difficulty in turning or cracks in the in the housing. Contrarily the bearing is replaced. If it is determined that the damage to the bearing is due to intrusion of solid objects into the pellet carrier (due to user's mistake or the manufacturer of pellet mistake), Co. "Radijator Engineering" shall charge value of the bearing. If the damage to the bearing is due to the withdrawal of the flame into the pellet transporter itself for reasons of poorly set parameters when using the boiler, Co. "Radijator Engineering" shall charge the value of the bearing.

- removing the chains on both sides of the shaft of the cellular security conveyor (valvoles) and inspection of the proper condition of the bearings 6004 in the valvoles. If rotating of the bearings is difficult, replace the bearings on both sides. If the damage of the bearings of valvoles is due to intrusion of solid body that is not from the boiler (due to user's mistake or manufacturer's of pellets mistake) Co. "Radijator engineering" shall charge the value of the bearings ;
- check the sharpness of the edges of the rotor;
- remove the probe of the flue gas and clean the layers of sediment;
- check fan;
- check the sealing of the upper and lower doors;
- check the maintenance of the boiler heat exchanger.

GARANTNI LIST / GUARANTEE LIST

Tip kotla / Boiler type

Fabri ki broj / Factory No.

Garantni rok / Guarantee period

60 MESECI/ 60 MONTHS

**Datum proizvodnje /
Date of manufacture**

**Potpis ovlaš enog lica /
Signature of Authorized person**

pe at / stamp

Prodato u firmi / Company of Sale

Adresa / Address

Telefon / Phone

Datum prodaje / Date of Sale

Potpis / Signature

pe at / stamp

*Potroša ima sva prava na osnovu Zakona o zaštiti potroša a ("Sl.glasnik RS", br. erbia62/2014). Garancija ne isklju uje niti uti e na prava potroša a koja proizilaze iz zakonske odgovornosti prodavca za nesaobczimost robe u ugovoru./ The consumer shall exercise all rights under the Consumer Protection Law ("OJ of RS" No 62/2014). The guarantee does not exclude nor affect the consumer's rights derived from the legal liability of the seller for any lack of conformity of the goods under a Contract.

*Gore navedeno važi za kupce na prostoru Republike Srbije./ The aforementioned applies to purchasers of the Republic of Serbia.