

# TBV-C



**Combined control & balancing valves for small terminal units**

For ON-OFF control

# TBV-C

Designed for use in terminal units in heating and cooling systems, the TBV-C ensures accurate hydronic control and optimum throughput over a long lifetime. IMI Hydronic Engineering's dezincification resistant alloy, AMETAL<sup>®</sup>, minimises the risk of leakage.

## Key features

- > **Presetting tool**  
For accurate and easy balancing.
- > **Self-sealing measuring points**  
For quick and easy measurement.
- > **Shut-off function**  
Ensures straightforward maintenance procedures.



## Technical description

### Application:

Heating and cooling systems.

### Functions:

Control  
Balancing  
Pre-setting  
Measuring  
Shut-off (for isolation during system maintenance)

### Dimensions:

DN 15-25

### Pressure class:

PN 16

### Temperature:

Max. working temperature: 120°C  
Min. working temperature: -20°C

### Leakage rate:

Tight sealing

### Material:

Valve body: AMETAL<sup>®</sup>  
Seat seal: Valve disc of EPDM (DN 15-20). EPDM/AMETAL<sup>®</sup> (DN 25).  
Spindle seal: EPDM O-ring  
Valve insert: AMETAL<sup>®</sup>, PPS (polyphenylsulphide)  
Return spring: Stainless steel  
Spindle: AMETAL<sup>®</sup>  
Smooth ends:  
Nipple: AMETAL<sup>®</sup>

AMETAL<sup>®</sup> is the dezincification resistant alloy of IMI Hydronic Engineering.

### Marking:

Body: TA, PN 16/150, DN, inch size and flow direction arrow.

Identification ring on measuring point:

White = Low flow (LF)

Black = Normal flow (NF)

### Actuators:

See separate information on EMO T.

## Sizing

When  $\Delta p$  and the design flow are known, use the formula to calculate the Kv-value.

$$Kv = 0,01 \frac{q}{\sqrt{\Delta p}} \quad q \text{ l/h, } \Delta p \text{ kPa}$$

$$Kv = 36 \frac{q}{\sqrt{\Delta p}} \quad q \text{ l/s, } \Delta p \text{ kPa}$$

## Setting

TBV-C is delivered with a red protective cap, Article No 52 143-100, which must be used when isolating the valve.

TBV-C is delivered with the pre-setting fully open. The setting of a valve for a given pressure drop, e.g. corresponding to position 5 is done as follows:

1. Place the presetting tool, Article No 52 133-100, at the valve.
2. Turn the presetting tool so that position 5 is pointing at the index\* of the valve body.
3. Remove the presetting tool. The valve is now set.

There is a diagram for every valve size that shows the flow for different pressure drops and settings.

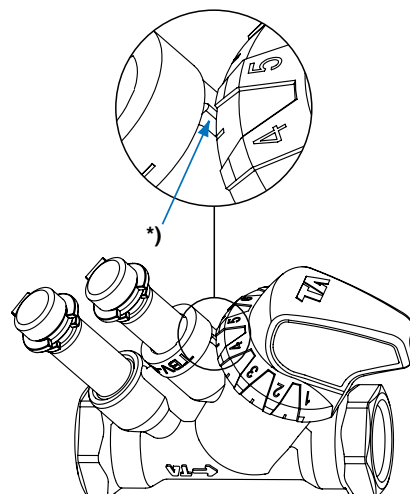

## Noise

The following conditions must be fulfilled in order to avoid noise in the heating system:

- Flows correctly balanced
- The water in the system must have been de-aerated
- Circulation pumps which do not generate excessive differential pressures (alternatively use a differential pressure controller, e.g. STAP)

The maximum recommended pressure drop in order to avoid noise is 30 kPa = 0,3 bar.

## Measuring accuracy

### Flow deviation at different settings



\*) Position

Try to avoid mounting taps and pumps, immediately before the valve.

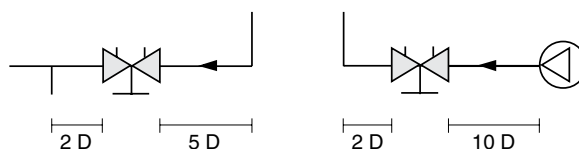

## Installation

### Application example

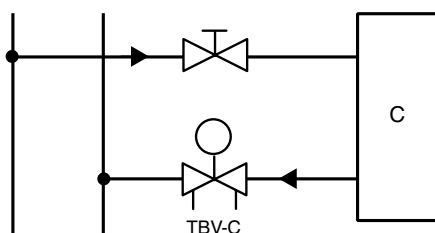

### Flow direction

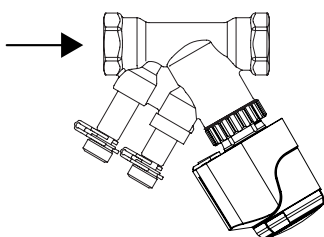

### Installation of actuator EMO T

Approx. 15 mm of free space is required above the actuator.

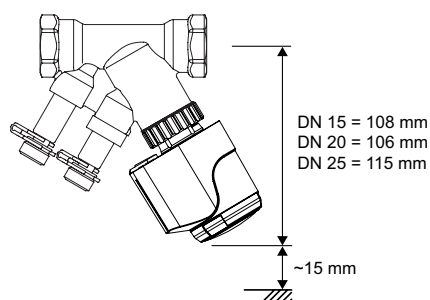

### TBV-C + EMO T

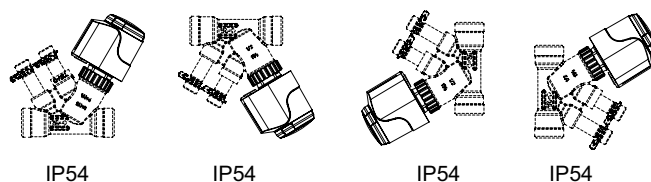

## Closing force

Necessary force (F) to close the valve versus the differential pressure ( $\Delta p$ ).

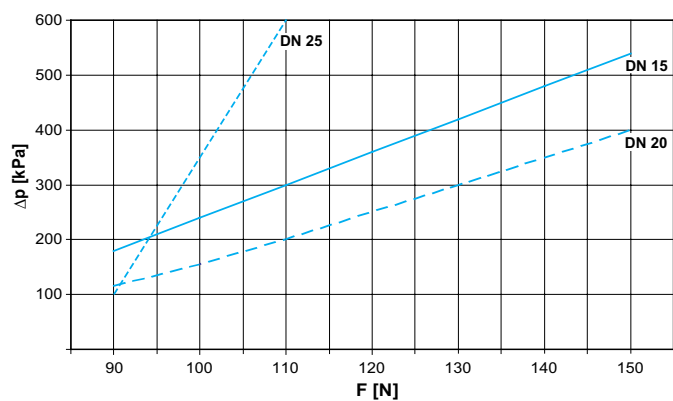

## Diagram TBV-C LF, DN 15

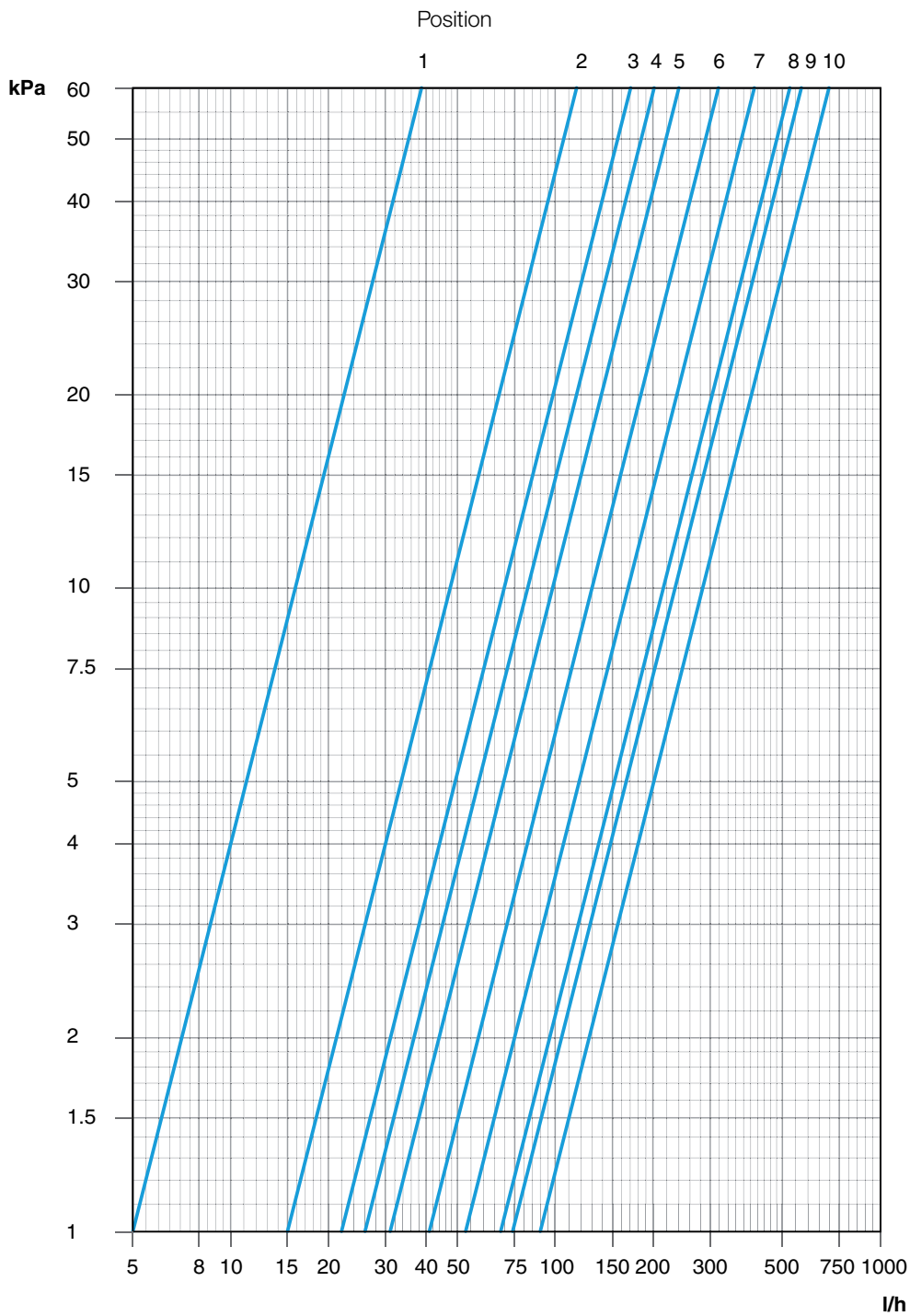

Position	1	2	3	4	5	6	7	8	9	10
Kv	0,05	0,15	0,22	0,26	0,31	0,41	0,53	0,68	0,74	0,90

Recommended setting: Position 3-10

### Diagram TBV-C NF, DN 15

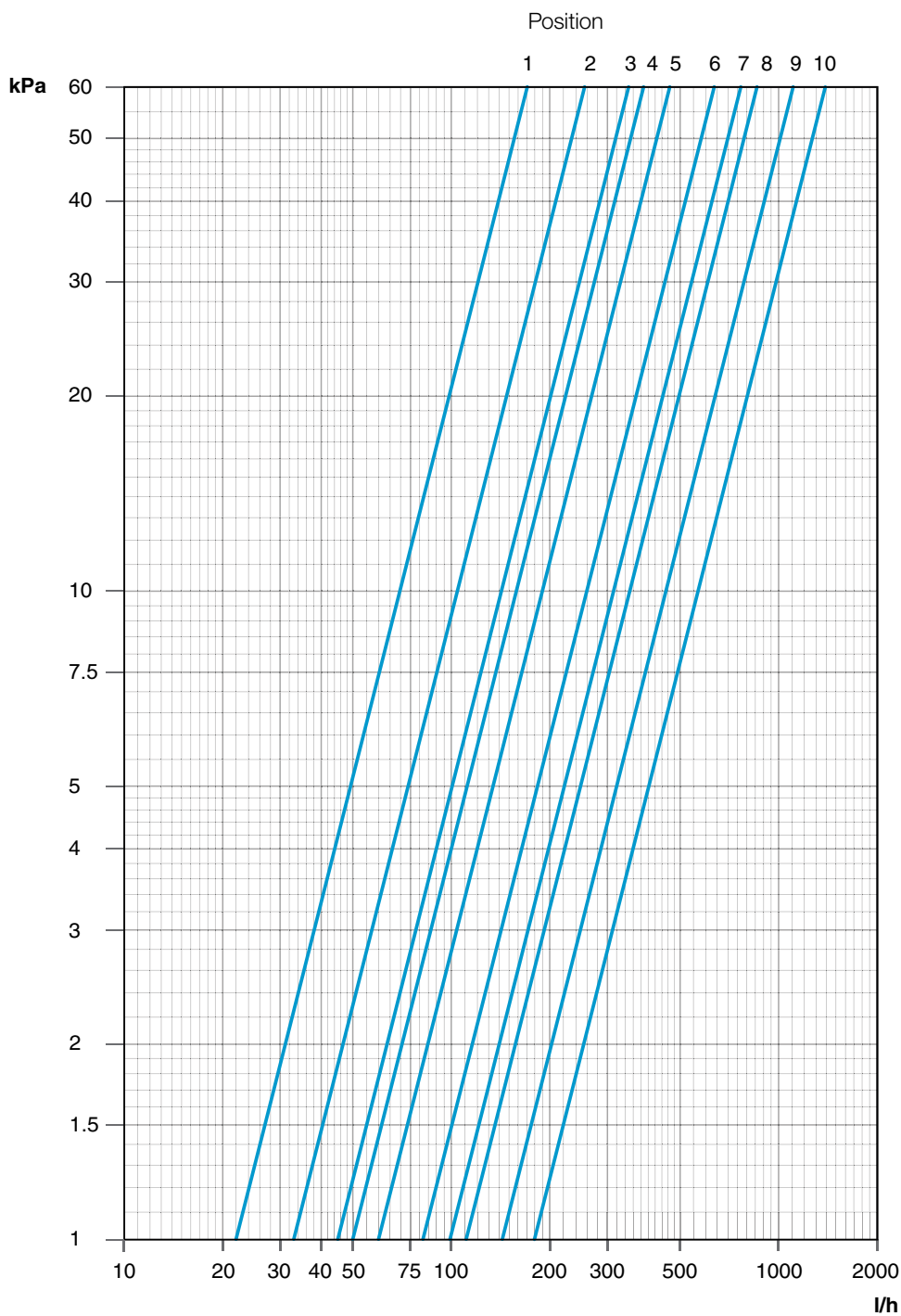

Position	1	2	3	4	5	6	7	8	9	10
<b>Kv</b>	0,22	0,33	0,45	0,50	0,60	0,82	0,99	1,1	1,4	1,8

Recommended setting: Position 3-10

## Diagram TBV-C NF, DN 20

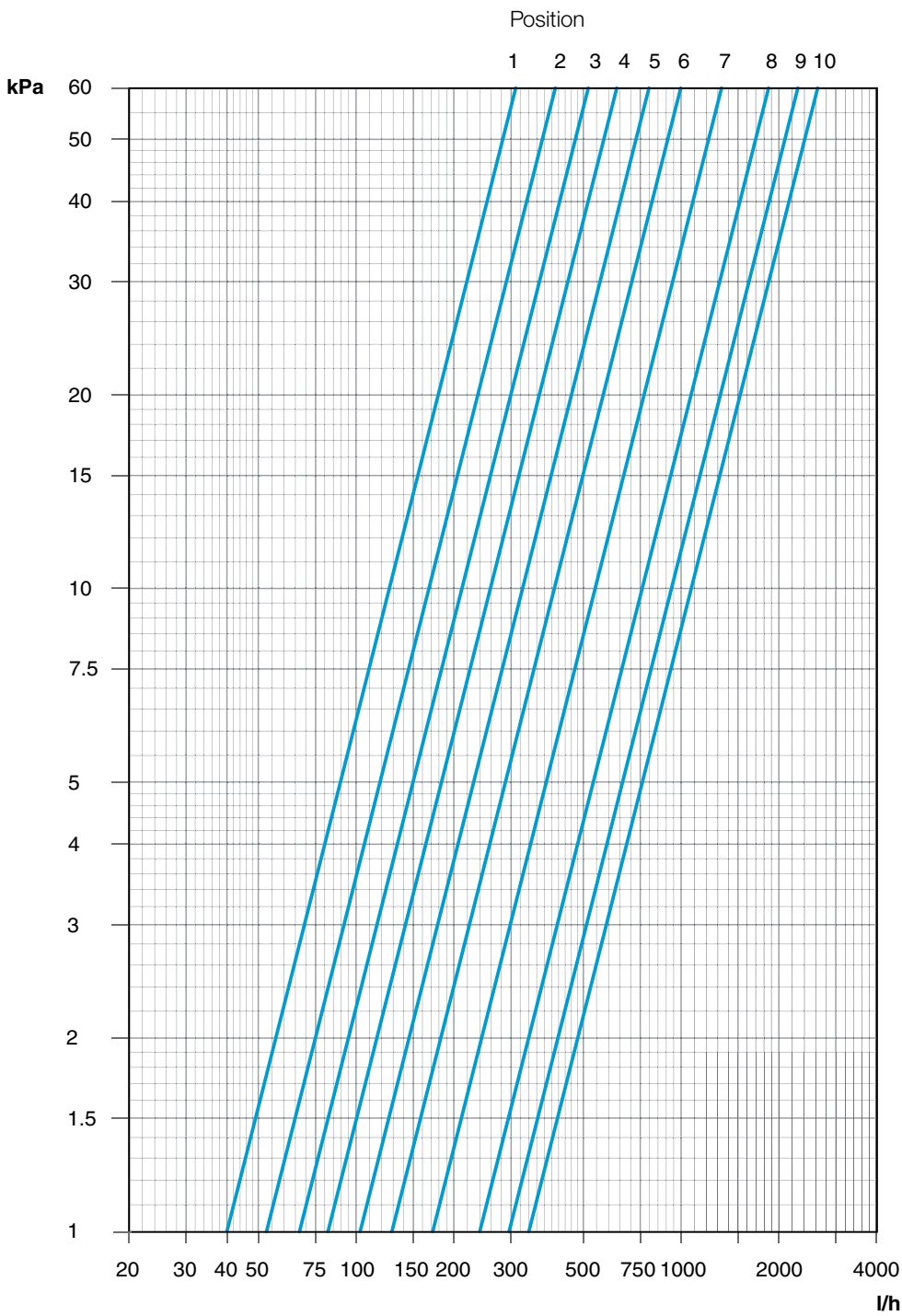

Position	1	2	3	4	5	6	7	8	9	10
Kv	0,40	0,53	0,67	0,82	1,0	1,3	1,7	2,4	3,0	3,4

Recommended setting: Position 3-10

### Diagram TBV-C NF, DN 25

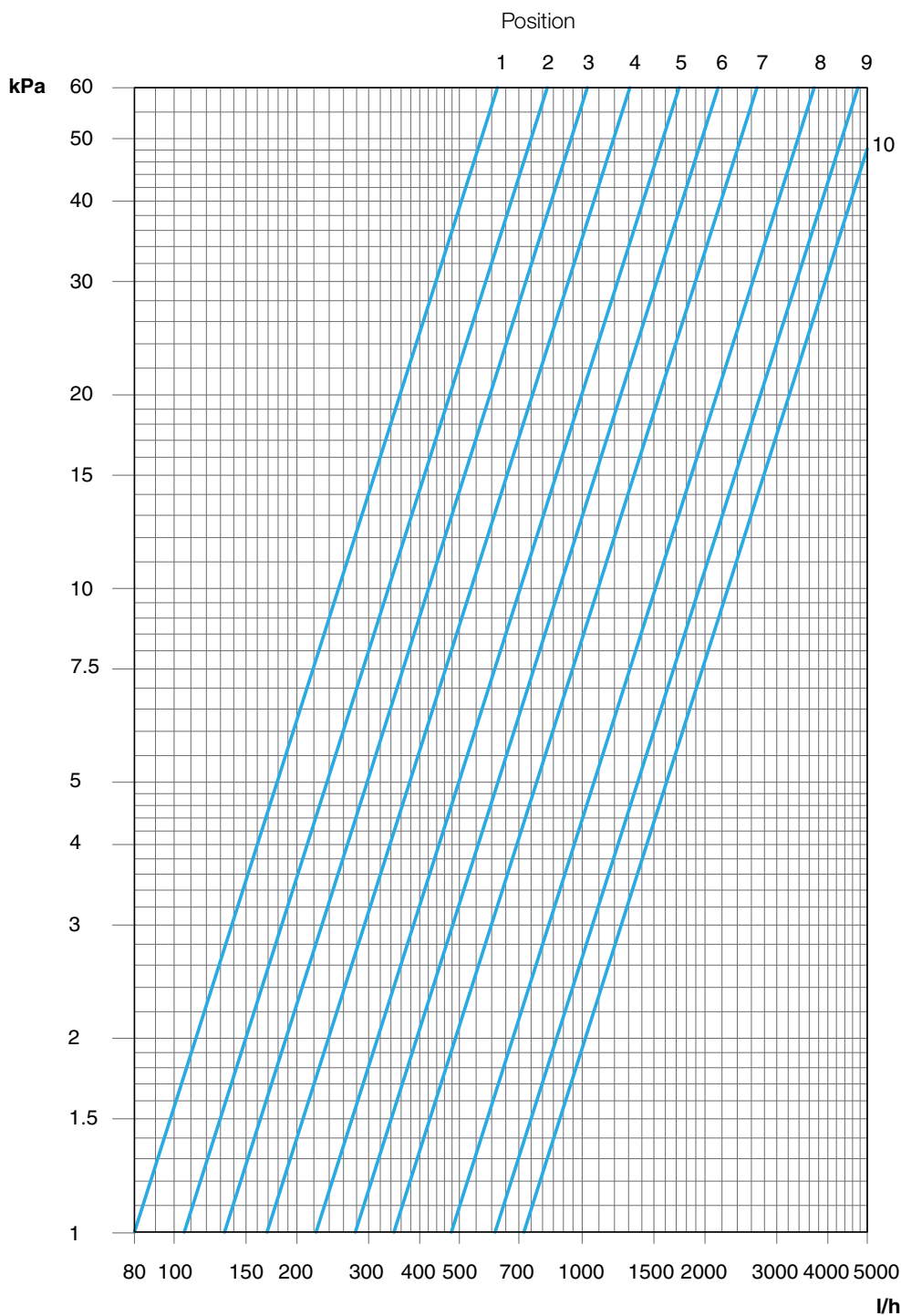

Position	1	2	3	4	5	6	7	8	9	10
Kv	0,80	1,0	1,3	1,7	2,2	2,8	3,5	4,8	6,1	7,2

Recommended setting: Position 3-10



## Articles

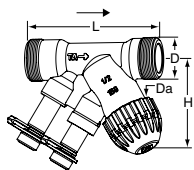

### Male thread

DN	D	Da*	L	H	Kvs	Kg	EAN	Article No
<b>TBV-C LF, low flow</b>								
15	G3/4	M30x1,5	85	58	0,90	0,35	7318793870506	52 133-015
<b>TBV-C NF, normal flow</b>								
15	G3/4	M30x1,5	85	58	1,8	0,35	7318793870803	52 134-015
20	G1	M30x1,5	96	57	3,4	0,40	7318793870902	52 134-020

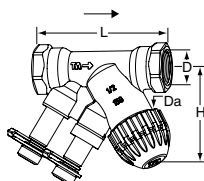

### Female thread

DN	D	Da*	L	H	Kvs	Kg	EAN	Article No
<b>TBV-C LF, low flow</b>								
15	G1/2**	M30x1,5	81	58	0,90	0,34	7318793859204	52 133-115
<b>TBV-C NF, normal flow</b>								
15	G1/2**	M30x1,5	81	58	1,8	0,34	7318793871008	52 134-115
20	G3/4**	M30x1,5	91	57	3,4	0,40	7318793871107	52 134-120
25	G1	M30x1,5	111	64	7,2	0,73	7318793966100	52 134-125

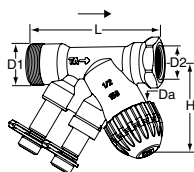

### Male thread with eurocone x Female thread

DN	D1	D2	Da*	L	H	Kvs	Kg	EAN	Article No
<b>TBV-C LF, low flow</b>									
15	G3/4	G1/2**	M30x1,5	85	58	0,90	0,36	7318793870605	52 133-215
<b>TBV-C NF, normal flow</b>									
15	G3/4	G1/2**	M30x1,5	85	58	1,8	0,35	7318793871206	52 134-215

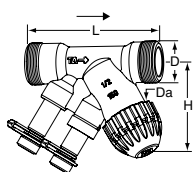

### Male thread with eurocone

DN	D	Da*	L	H	Kvs	Kg	EAN	Article No
<b>TBV-C LF, low flow</b>								
15	G3/4	M30x1,5	84	58	0,90	0,35	7318793870704	52 133-315
<b>TBV-C NF, normal flow</b>								
15	G3/4	M30x1,5	84	58	1,8	0,34	7318793871305	52 134-315

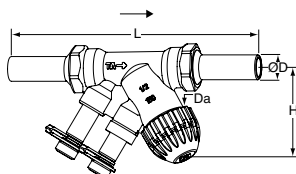

### Smooth ends

DN	D	Da*	L	H	Kvs	Kg	EAN	Article No
<b>TBV-C LF, low flow</b>								
15	15	M30x1,5	145	58	0,90	0,44	7318793935700	52 433-115
<b>TBV-C NF, normal flow</b>								
15	15	M30x1,5	145	58	1,8	0,44	7318793935908	52 434-115
20	22	M30x1,5	173	57	3,4	0,57	7318793936103	52 434-120

\*) Connection to actuator.

\*\*) Can be connected to smooth pipes by KOMBI compression coupling. See catalogue leaflet KOMBI.

G = Thread according to ISO 228. Thread length according to ISO 7/1.

Kvs = m<sup>3</sup>/h at a pressure drop of 1 bar and fully open valve.

→ = Flow direction

## Connections for male thread

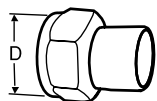

### Welding connection

Swivelling nut  
Max 120°C

Valve DN	D	Ø Pipe	EAN	Article No
15	G3/4	15	7318792748509	52 009-015
20	G1	20	7318792748608	52 009-020

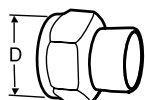

### Soldering connection

Swivelling nut  
Max 120°C

Valve DN	D	Ø Pipe	EAN	Article No
15	G3/4	15	7318792749308	52 009-515
15	G3/4	16	7318792749407	52 009-516
20	G1	18	7318792749506	52 009-518
20	G1	22	7318792749605	52 009-522

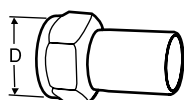

### Connection with smooth end

For connection with press coupling  
Swivelling nut  
max 120°C

Valve DN	D	Ø Pipe	EAN	Article No
15	G3/4	15	7318793810601	52 009-315
20	G1	18	7318793810700	52 009-318
20	G1	22	7318793810809	52 009-322

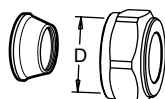

### Compression connection

max 100°C  
Support bushes shall be used, for more  
information see catalogue leaflet FPL.

Valve DN	D	Ø Pipe	EAN	Article No
15	G3/4	15	7318793705006	53 319-615
15	G3/4	18	7318793705105	53 319-618
15	G3/4	22	7318793705204	53 319-622
20	G1	28	7318793705402	53 319-928

## Connections for male thread with eurocone

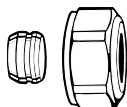

### Compression fitting for copper or steel pipes

For eurocone  
Metal-to-metal sealing  
Support bushes shall be used.

Ø Pipe	EAN	Article No
12	4024052214211	3831-12.351
15	4024052214617	3831-15.351
16	4024052214914	3831-16.351
18	4024052215218	3831-18.351

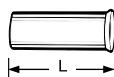

### Support sleeve

for copper or precision steel pipe with a 1 mm wall thickness.  
Brass.

Ø Pipe	L	EAN	Article No
12	25,0	4024052127016	1300-12.170
15	26,0	4024052127917	1300-15.170
16	26,3	4024052128419	1300-16.170
18	26,8	4024052128815	1300-18.170

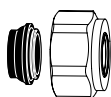

### Compression fitting for copper or steel pipes

For eurocone  
Nickel plated, soft sealing (EPDM)

Ø Pipe	EAN	Article No
15	4024052515851	1313-15.351
18	4024052516056	1313-18.351



### Compression fitting for plastic pipes

For eurocone

Ø Pipe	EAN	Article No
14x2	4024052134618	1311-14.351
16x2	4024052134816	1311-16.351
17x2	4024052134915	1311-17.351
18x2	4024052135110	1311-18.351
20x2	4024052135318	1311-20.351



### Compression fitting for multi-layer pipes

For eurocone

Ø Pipe	EAN	Article No
16x2	4024052137312	1331-16.351

## Accessories



### Presetting tool

For TBV-C, TBV-CM

EAN	Article No
7318793886002	52 133-100

### Actuator EMO T

For more details of EMO T, see separate catalogue leaflet.

TBV-C is developed to work together with the EMO T actuator. Actuators of other brands require a working range of:

X (closed - fully open) = 11,4 - 15,1 (DN 15-20) / 11,4 - 15,8 (DN 25)

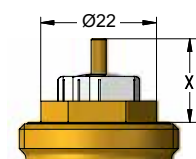

IMI Hydronic Engineering will not be held responsible for the control function if actuators other brand than IMI TA are used.

