

JP / JP PM JP PT-V / JP PT-H



Further product documentation
net.grundfos.com/qr/i/99520338

be
think
innovate

GRUNDFOS 

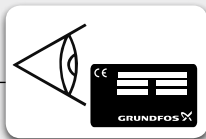

Min./Max. 0/40 °C (S3: 60 °C)
Min./Max. 32/104 °F (S3: 140 °F)



$P_{max} = 6 \text{ bar (87 psi)}$



• Voltage [V] • Connection:
• Frequency [Hz] GAS / NPT

Min./Max. 0/40 °C (S3: 55 °C)
Min./Max. 32/104 °F (S3: 131 °F)



JP

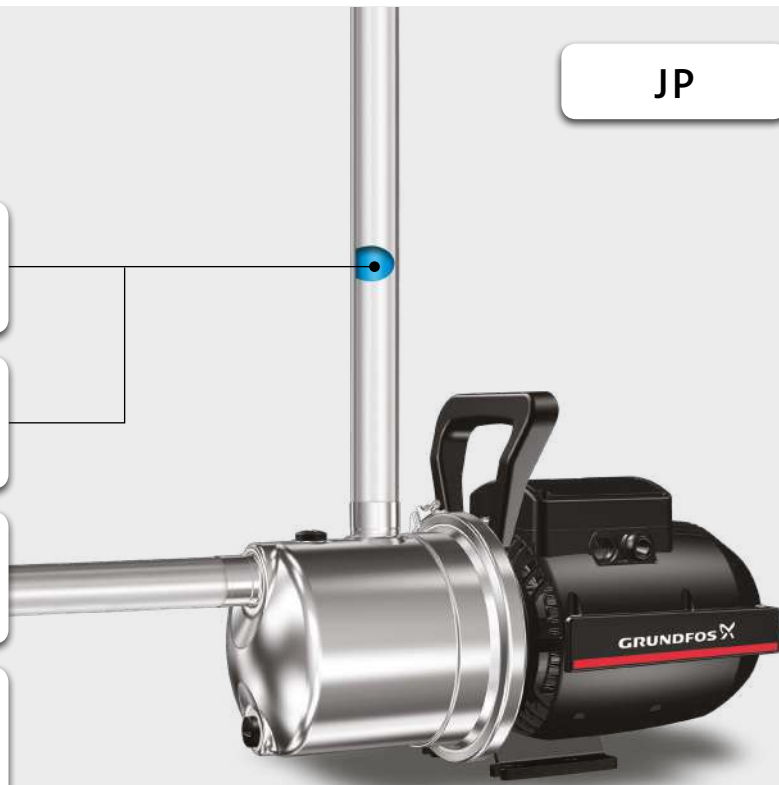

JP

Max. 8 m / 26 ft

≥ 0.5 m / 1.64 ft

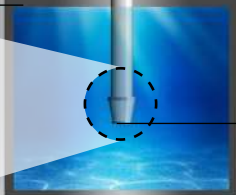
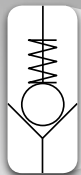
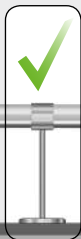
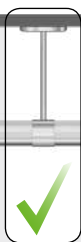

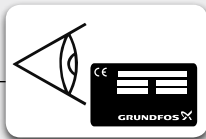

Min./Max. 0/40 °C (S3: 60 °C)
 Min./Max. 32/104 °F (S3: 140 °F)



$P_{max} = 6 \text{ bar (87 psi)}$



• Voltage [V] • Connection:
 • Frequency [Hz] GAS / NPT

Min./Max. 0/40 °C (S3: 55 °C)
 Min./Max. 32/104 °F (S3: 131 °F)



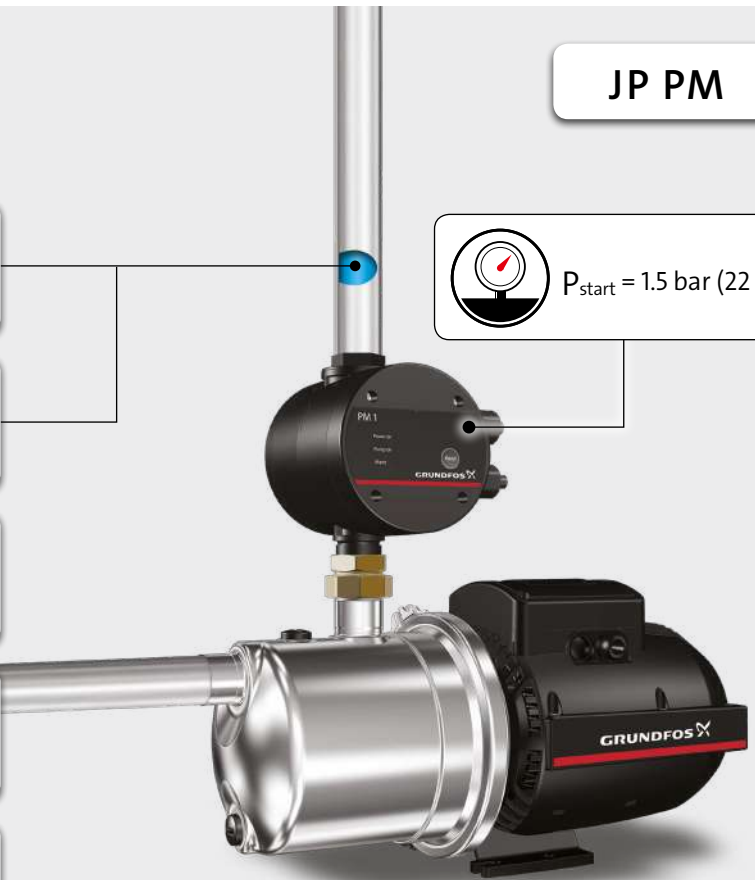

JP PM

 $P_{start} = 1.5 \text{ bar (22 psi)}$

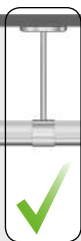

JP PM



Max. 10 m



Max. 8 m / 26 ft

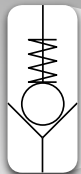

≥ 0.5 m / 1.64 ft

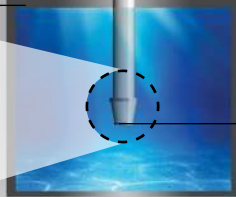

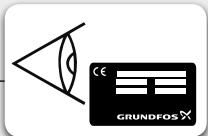

Min./Max. 0/40 °C (S3: 60 °C)
Min./Max. 32/104 °F (S3: 140 °F)



$P_{max} = 6 \text{ bar (87 psi)}$



• Voltage [V] • Connection:
• Frequency [Hz] GAS

Min./Max. 0/40 °C (S3: 55 °C)
Min./Max. 32/104 °F (S3: 131 °F)



JP PT-V

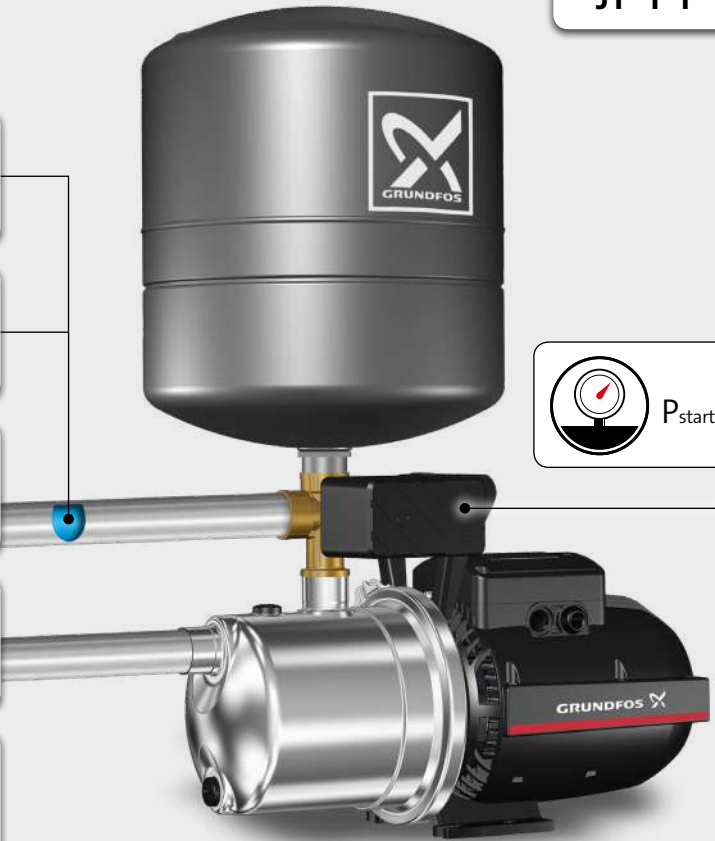

$P_{start} = 2.2 \text{ bar}$

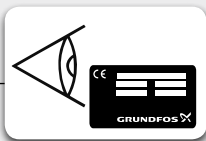

Min./Max. 0/40 °C (S3: 60 °C)
Min./Max. 32/104 °F (S3: 140 °F)



$P_{max} = 6 \text{ bar (87 psi)}$



- Voltage [V]
- Frequency [Hz]
- Connection: GAS

Min./Max. 0/40 °C (S3: 55 °C)
Min./Max. 32/104 °F (S3: 131 °F)



JP PT-H



$P_{start} = 2.2 \text{ bar}$



JP PT-H

(32 psi)

Max. 8 m / 26 ft

≥ 0.5 m / 1.64 ft

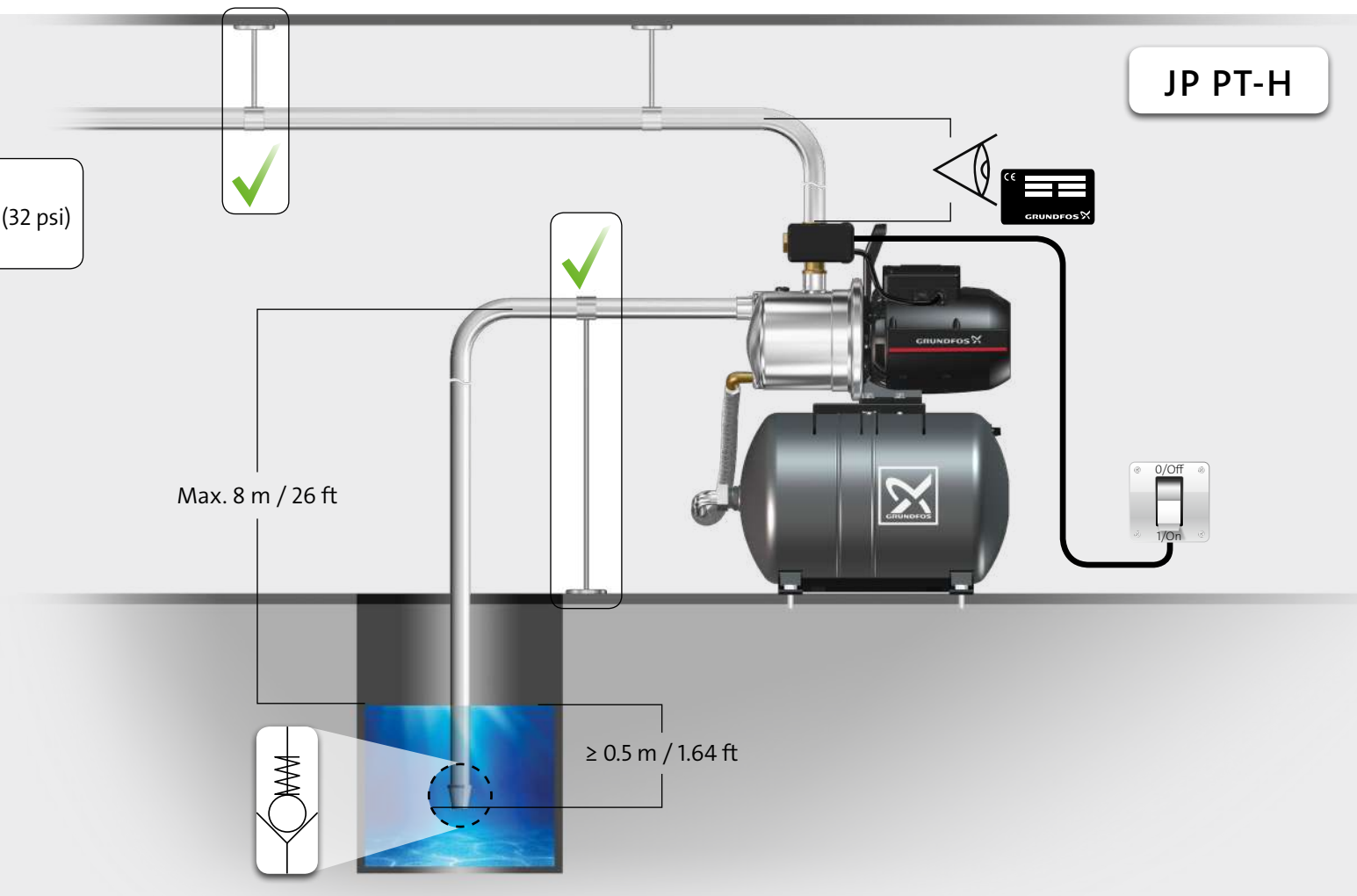

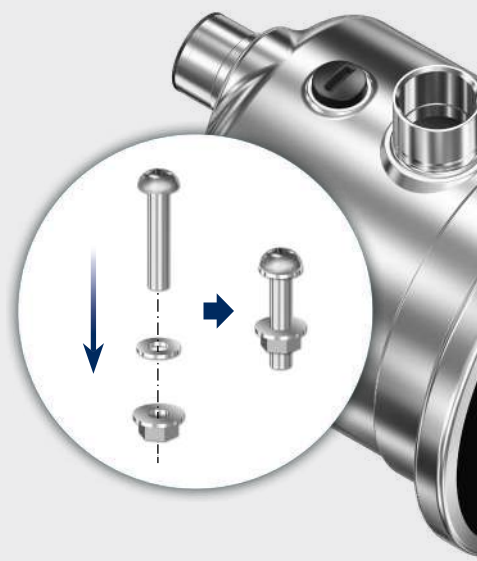
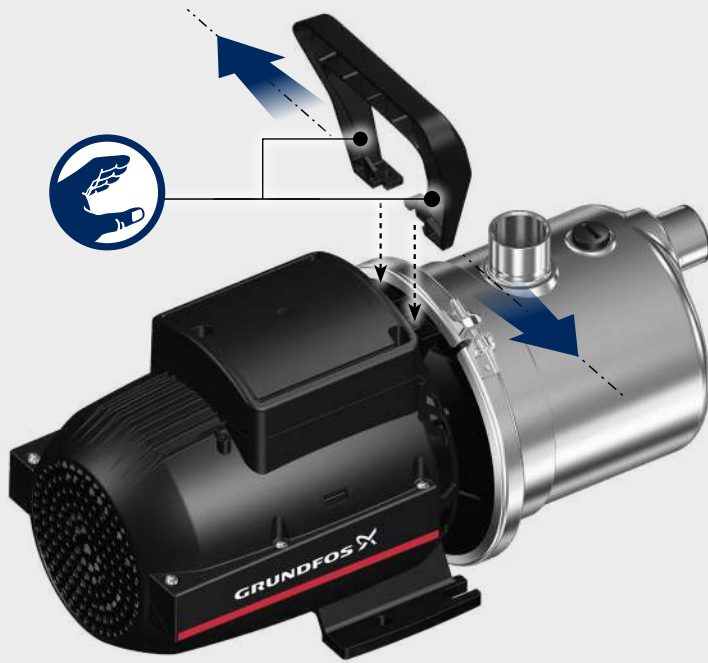

JP



1A

JP / JP PM/ JP

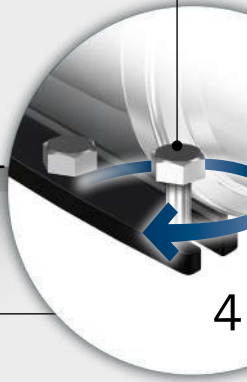
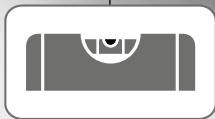
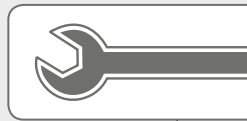
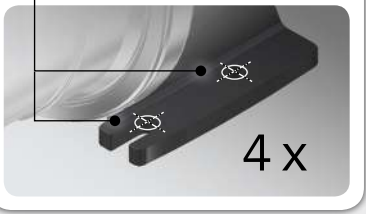
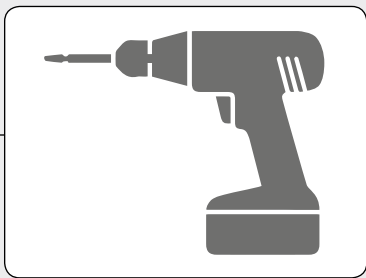

PT-V

1B

JP PT-H

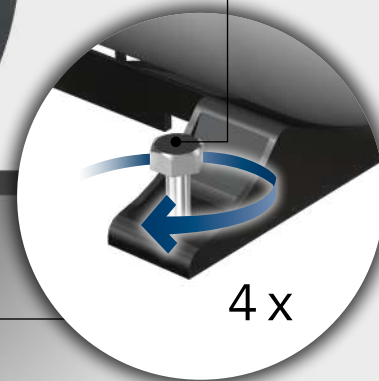
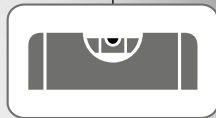



2a

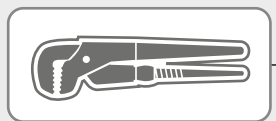

JP

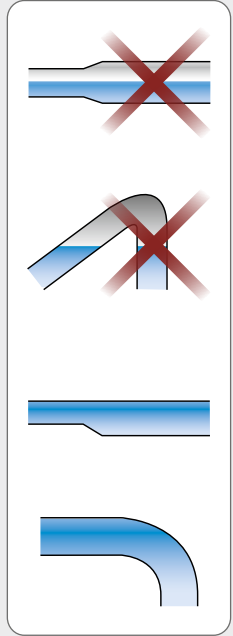

2b

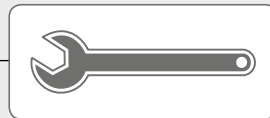
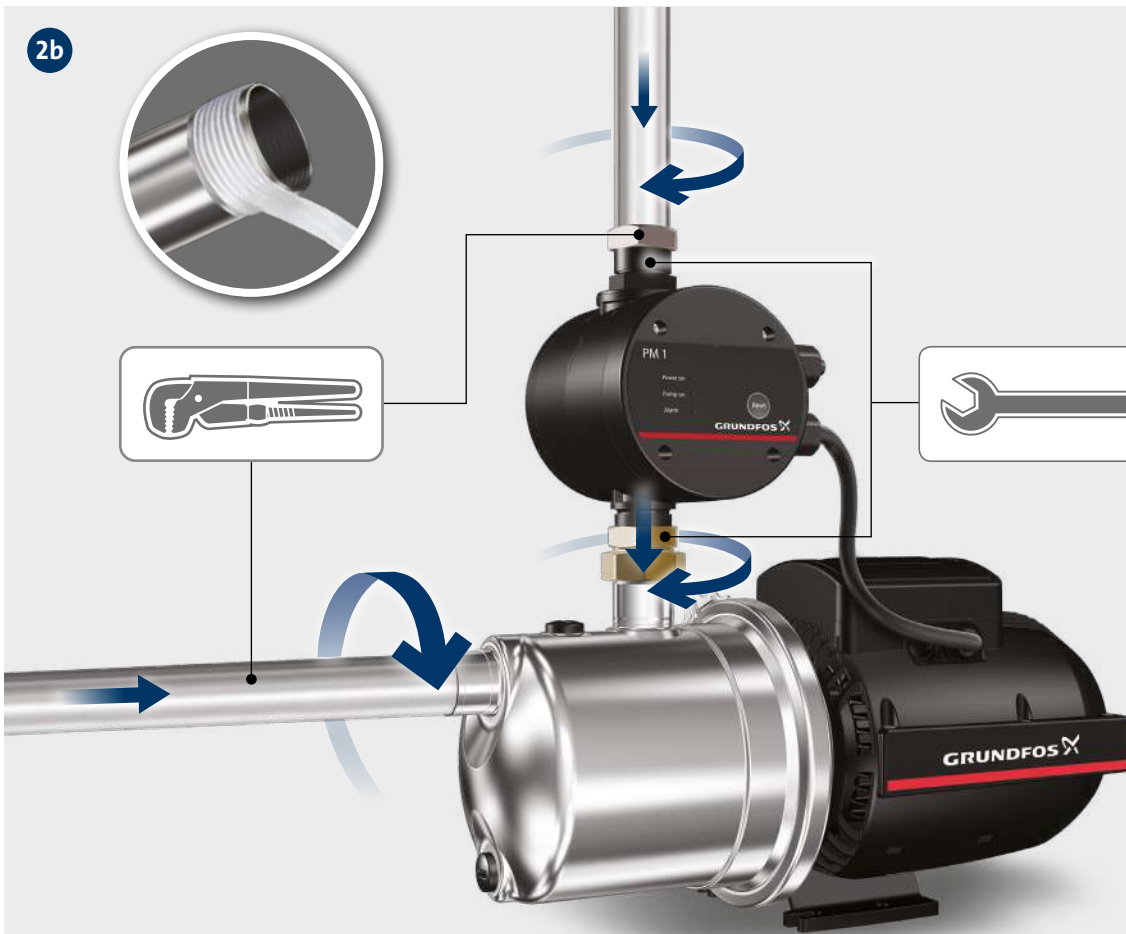
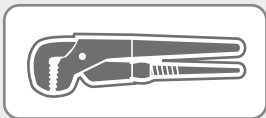

JP PM

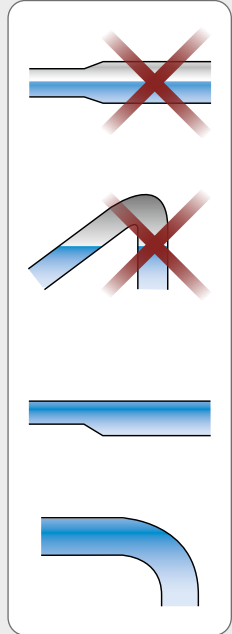

2c

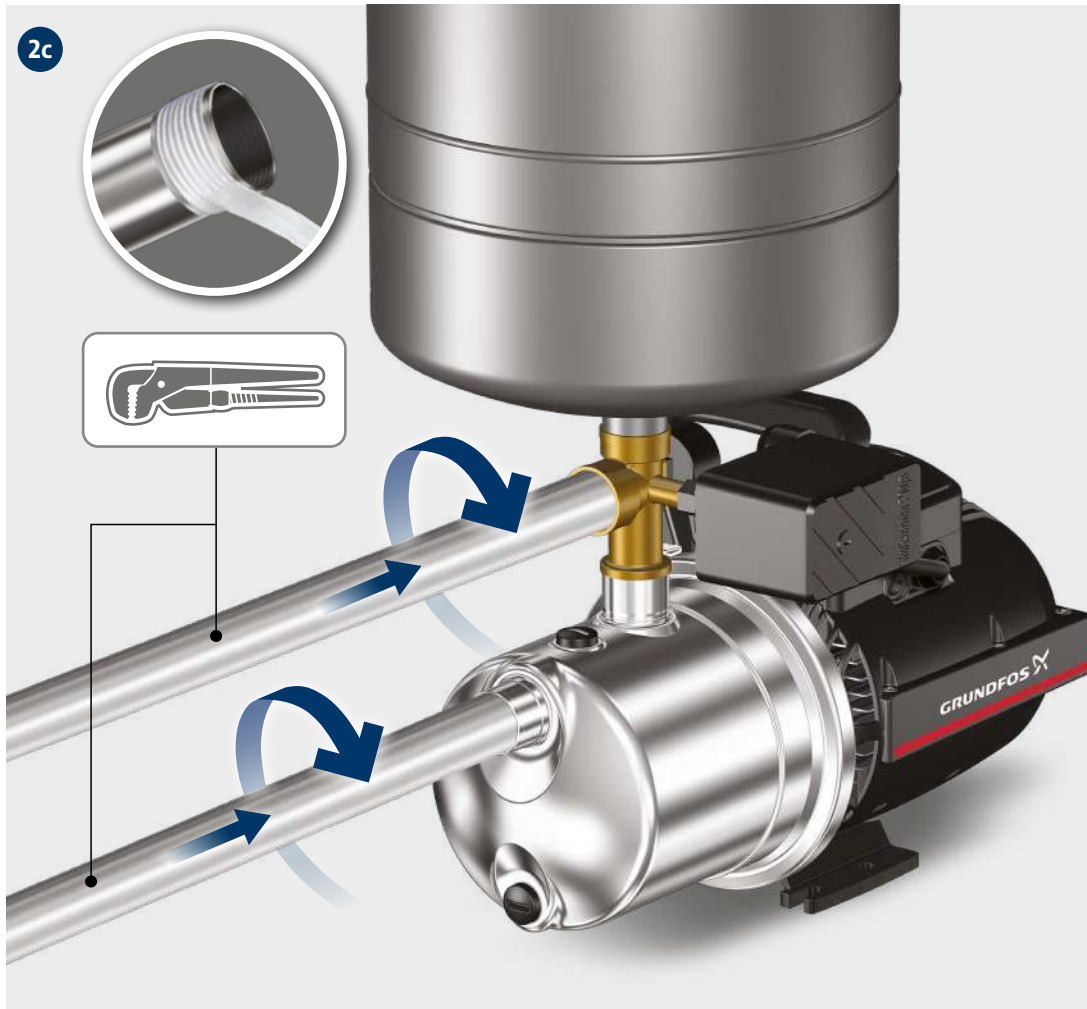
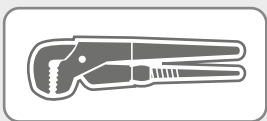

JP PT-V

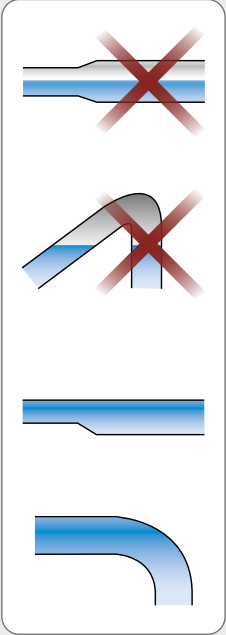

2d

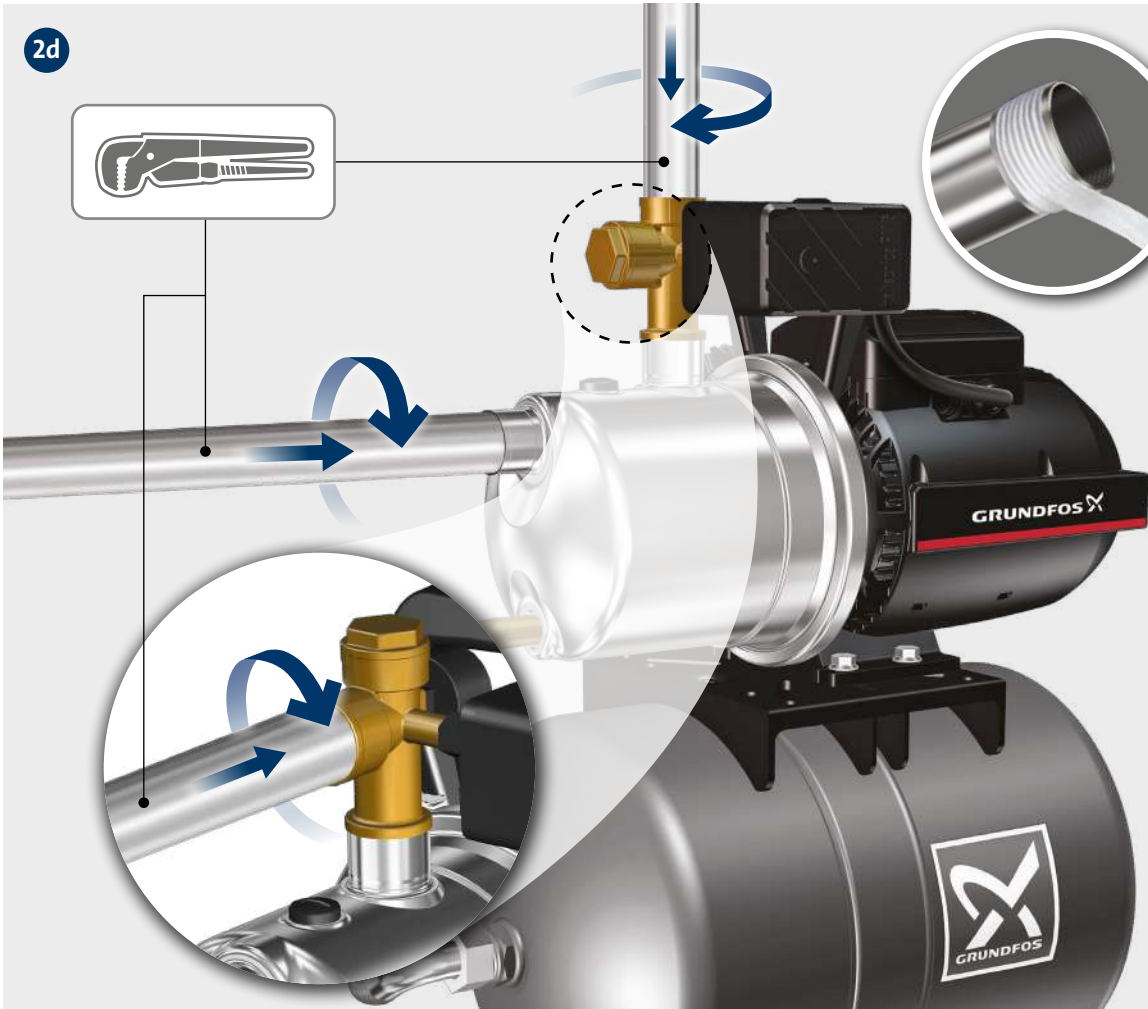
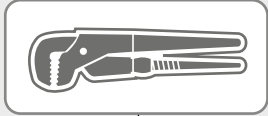

JP PT-H

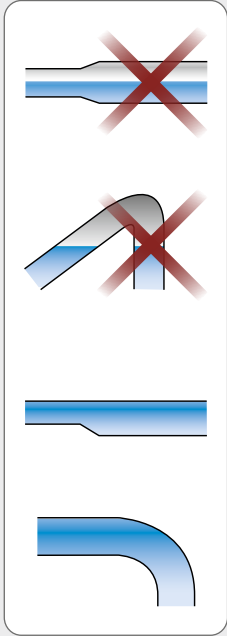



3

JP / JP PM / JP PT-V / JP PT-H

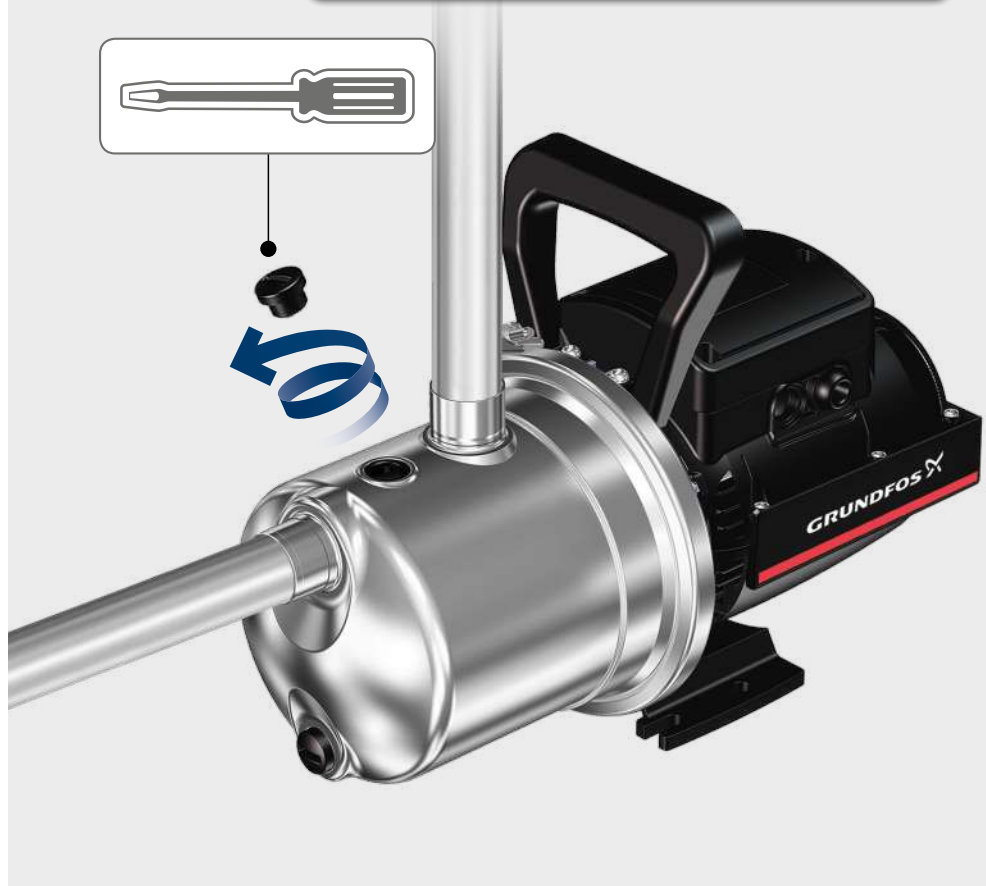
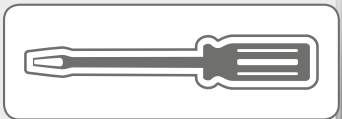

4





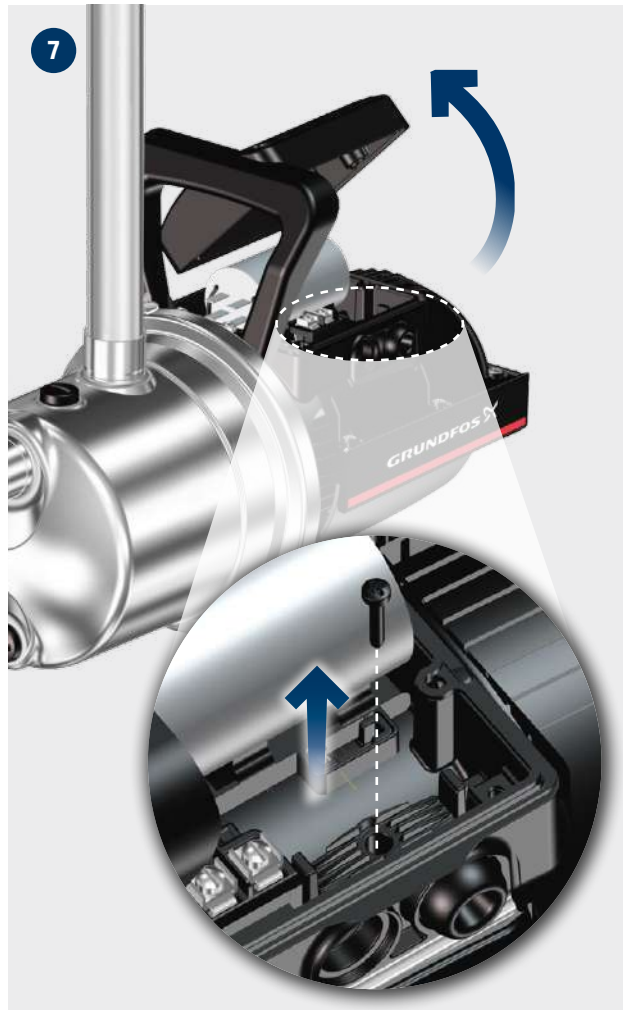

JP / JP PM / JP PT-V / JP PT-H

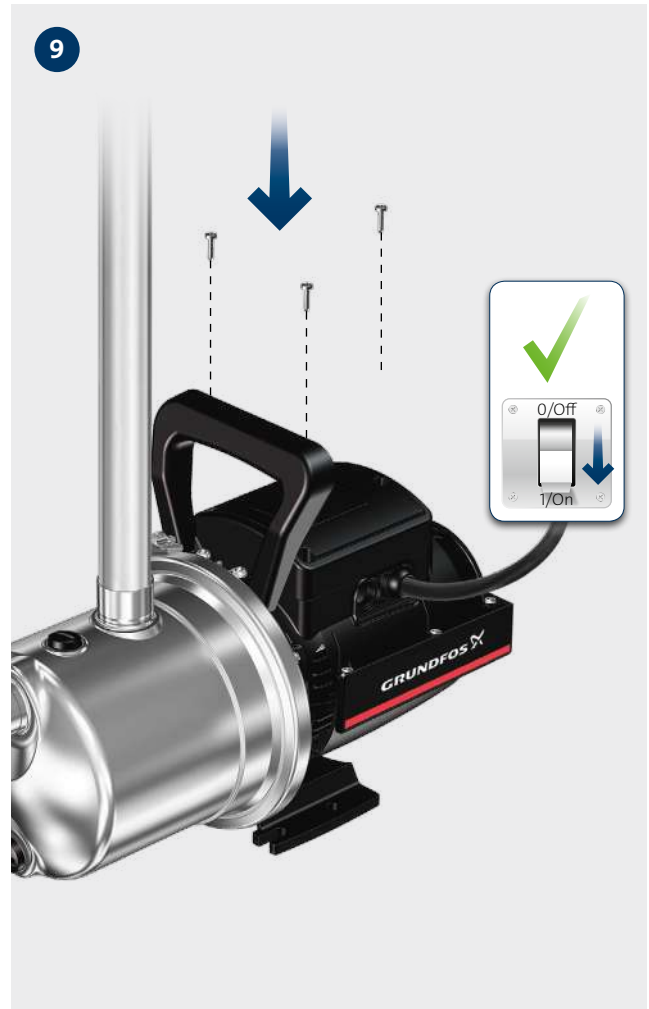

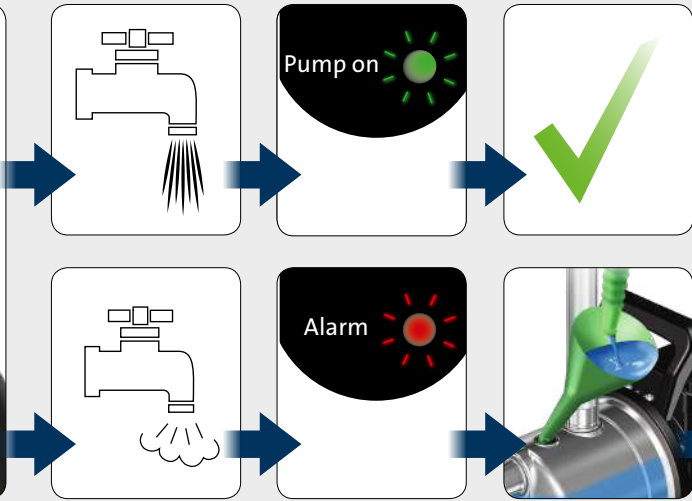

JP PM

Reset



net.grundfos.com/qr/i/99520338



JP / JP PM / JP PT-V / JP PT-H

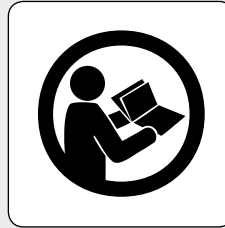

be think innovate

Installation date: _____

Installer:

99544277 1218

ECM: 1249679

GRUNDFOS Holding A/S
Poul Due Jensens Vej 7
DK-8850 Bjerringbro
Tel: +45 87 50 14 00
www.grundfos.com

GRUNDFOS 

Trademarks displayed in this material, including but not limited to Grundfos, the Grundfos logo and "be think innovate", are registered trademarks owned by The Grundfos Group. All rights reserved.
© 2018 Grundfos Holding A/S, all rights reserved.