

HYDROCAL-M4

USER MANUAL



Table of Contents

1. Introduction	3
WARNING	3
PACKAGING CONTENT	3
STORAGE CONDITIONS	3
GENERAL INFORMATION	3
2. Safety information	4
3. Installation	6
BEFORE INSTALLATION	6
INSTALLATION	6
ALLOWED INSTALLATION POSITIONS	7
TEMPERATURE SENSOR INSTALLATION	7
4. Functionality	9
5. Display and buttons	9
6. Commissioning	10
PROCEDURE FOR COMMISSIONING	11
7. Consultation menu	11
LEVEL S1: INITIALIZATION	12
LEVEL S2: CONFIGURATION AND INITIALIZATION	12
LEVEL 2: INSTANTANEOUS OPERATING VALUES	13
LEVEL 3: SETTINGS (DISPLAYING ONLY)	14
LEVEL 4: STORAGE DAY DATA 1-2	16
LEVEL 5: COUNTER DATA	17
LEVEL 6: MONTHLY/BIWEEKLY HISTORICAL DATA	17
LEVEL 7: ANNUAL HISTORICAL DATA	18
LEVEL 8: ERRORS AND ANOMALIES	19
LEVEL 9: ERROR LOG	19
8. Operating mode – Radio activation	20
RADIO PARAMETERS	20
RADIO INDICATOR ON DISPLAY	21
9. Errors and faults	22
10. Battery and replacement procedures	25
11. Thermal energy meter - Technical Data	26
12. Information for the correct disposal of the product	27
13. Head Loss Curve	27
14. Quick menu scheme	28
Attachment “A”	30
Contacts	31



1. Introduction

The **HYDROCAL-M4** is a compact thermal energy meter that measures the thermal energy used in heating and cooling systems.

The meter allows to measure the thermal energy passing into a hydraulic circuit used for heating and/or for cooling, it also lets the acquisition through external module, of the volume measured by up to 2 device (water, heat, gas, electricity, HCA) equipped with pulse emitter.

The meter can also be connected to a consumption reading network based on the wired **M-BUS**, Wireless **M-BUS** and **LoraWan** network protocols.

WARNING

 **The first configuration chosen during installation (supply or return pipe) can't be modified!**

 The top calculation/electronic unit must not be separated from the bottom brass case.

 This meter contains potentially dangerous batteries, handle them with caution and do not disperse the components in the environment.

 The installation must be carried out by qualified personnel only. The manufacturer doesn't assume any responsibility for improper installation or damages caused by third parties.

PACKAGING CONTENT

- **HYDROCAL-M4** thermal energy meter
- Installation Manual
- Antifraud Kit

STORAGE CONDITIONS

The product must be stored in a dry place at temperatures between **-20 °C** and **+70 °C** (even during transport). The duration of the storage should not exceed **1 year**.

Combined heating or cooling meters are precision devices and must be protected from shock and vibration.

GENERAL INFORMATION

- Before proceeding with the installation and configuration of the product, carefully read the instructions in this manual. For further technical clarification, please contact Customer Service.
- Installation should be carried out exclusively by qualified personnel.
- The reference standard for the instrument is EN 1434 (1-6) and Directive 2014/32/EC (Annex MI-004).
- Any tampering of the meter or removal of the seals will void the warranty provided.
- For proper energy accounting, always respect the mounting type prescribed (inlet pipe installation/ return pipe installation).
- The configuration of installation version and unit of measurement can be done with the buttons or an Android device with NFC connectivity.
- Respect the installation point (input or output) of the instrument.

2. Safety information

- **Attention:** this symbol highlights the instructions to be followed scrupulously for the correct functioning of the combined heat and cooling meter.
- ⚠ **Danger:** the chapters marked with this symbol contain information that must be followed carefully to avoid dangerous situations. Thermal energy meters are precision devices and must be protected from shock and vibration.
- ⓘ **Notes:** the notes indicated by this symbol contain tips to keep in mind when using the thermal energy meter.

⚠ Read all instructions carefully before proceeding with the installation! Failure to comply with one or more of the procedures contained in the manual can be dangerous and cause damage to property and people. It is recommended to comply with all applicable laws on safety and accident prevention.

ⓘ	Observe national regulations relating to the measurement of cooling.
ⓘ	Observe the technical requirements relating to the installation of electrical equipment.
ⓘ	The instrument complies with the requirements of Directive 2014/30/EU of the European Council on electromagnetic compatibility, Directive 2014/35/EU on electrical safety and Directive RED 2014/53/EU.
ⓘ	If more than one instrument is installed in a unit, the installation conditions must be the same for all instruments to ensure that consumption is billed as possible.
→	The warranty and validity of the verification become void if the identification plate or the seals applied to the instrument are removed or damaged.
→	Remove the device from the package only at the time of installation to protect it from damage and dirt.
⚠	The air transport of active radio devices is prohibited.
⚠	Carefully observe the instructions in the data sheet, instruction manual, application notes and lid. Failure to comply with the operating conditions may result in situations of danger and forfeiture of all claims of liability for defects as well as liability based on any guarantees expressly granted. For more information visit the website www.bmeters.com .
⚠	Dispose of replaced devices and defective components in accordance with current environmental regulations.
⚠	Pay attention to the angular or sharp protrusions in the threads, flanges and measuring tube. Therefore, it is recommended to wear protective gloves.
⚠	The device shall be used in such a way as to minimize the potential for human contact during normal operation. To avoid the possibility of exceeding radio frequency exposure limits, human proximity to receivers with integrated antenna should not be less than 20 cm (8 inches) during normal operation.
⚠	Do not expose the meter to the sun and heat sources. Do not attempt to burn the device.
⚠	Store out of the reach of children.
⚠	In case of danger of frost, empty the system and, if necessary, remove the meter.
⚠	To clean the device externally use a soft cloth and moistened with water. Do not wash with high-pressure jets or soak the device in water. Avoid contact with oils and solvent. Do not use alcohol or detergents.
⚠	Do not damage the casing of the device. In the event of collisions of blunt objects on the front of the display, it can be irreparably damaged and lose the IP65 degree of protection. Install in areas protected against impacts. If the protective casing breaks, contact customer service.
ⓘ	The display turns off. To activate it, press the button on the device. The display remains active for 60 seconds.



	The meter is not suitable for drinking water but is suitable for circulating water in central heating systems. The quality of the water has to be as specified by the CEN/TR 16911 regulation.
→	Do not twist, wrap, extend or shorten the cables of the temperature probes and the cable that connects the electronic unit to the part of the lower-case body.
→	The thermal energy meter can be installed only in areas protected from frost.
→	The thermal energy meter must be protected against pressure shocks in the pipeline.
→	Slowly fill the pipe with water at the end of the installation.
→	After installing the meter perform a leak test of the system.
→	Assemble or disassemble the meter only after depressurization of the system.
→	The meter does not have lightning protection.
→	Thermal energy meters do not require special protection against electrical interference; however, electromagnetic interference must be avoided.
→	If transmission network interfaces are used, especially when cables are routed outside the building, use increased protection against electrical interference.
→	Rinse the pipes thoroughly before installing the meter.
→	The device must be installed pay attention to matching the direction of the arrow on the meter brass body to the direction of the flow.
→	Avoid collecting air bubbles in the meter during the installation process.
→	The thermal energy meter must not be subjected to mechanical stress when installed in the pipeline.
→	The meter must be installed in such a way as to be protected from all impurities and external contamination.
→	Manually and simultaneously screw the device fittings on both sides, and then tighten in opposite directions using a suitable tool.
→	Remove old seals and clean the sealing surfaces.
→	Slightly grease the sealing surfaces (use grease approved by MID Standards).
→	Mount only the newly supplied gaskets (gaskets should not get in the pipeline). Seals provided on site must be fit for purpose and comply with local guidelines and directives. B METERS disclaim all liability for consequential damage resulting from the use of third-party gaskets, such as corrosion of sealing surfaces and threads.

The table below presents troubleshooting steps:

Problem	Cause	Solution
Display off, pressing buttons does not respond	The battery may be damaged or discharged	Inform Customer Service
Damaged brass case or leakage	Possible external impact or fall to the ground	Inform Customer Service
Lower case brass separated by electronic unit	Tampering by third party or strong external impacts	Inform Customer Service
Open and visible electronic unit	Tampering by third party or strong external impacts	Inform Customer Service
No consumption is accounted	Tampering by third party, strong external shocks or damage to the flow detection sensor	Inform Customer Service
Error 12 always present	Damaged temperature probes	Inform Customer Service
Error 18 or 19 always present	Damaged temperature probes or out of system temperatures limits	Inform Customer Service
Does not transmit via radio	Failure to pass 5 absolute liters or the batteries may be damaged or discharged	Inform Customer Service

3. Installation

⚠ The first configuration chosen during installation (supply or return pipe) can't be modified!

BEFORE INSTALLATION

Before the thermal energy meter installation make sure that the two ends of the inlet and outlet pipe are perfectly aligned, clean them with the utmost care. Moreover, make sure there is a suitable filter placed at the inlet and that clean and undamaged gaskets are inserted on both sides.

The thermal energy meters must be installed as specified by the CEN-TR 13582 regulation.

Upstream and downstream the meter install an appropriate water flow interception and regulation devices suitable to allow inspection and maintenance of the meter, control of the water flow and eventual sealing of the system.

- Attention should be paid to the direction of flow. Install the thermal energy meter so that the passage of water takes place in the direction indicated by the arrow in relief on the brass body and respecting the prescribed position.
- To ensure proper measurement, make sure that there is no air inside the pipe and that the flow is clean and free of debris (potentially harmful to the meter turbine).

INSTALLATION

- It is mandatory to comply with the prescribed type of assembly (return pipe\supply pipe). Always refer to what is on the meter menu 3 level 06.
The figure below refers to a standard version of the device installation (mounting on return pipe) and positioned horizontally.

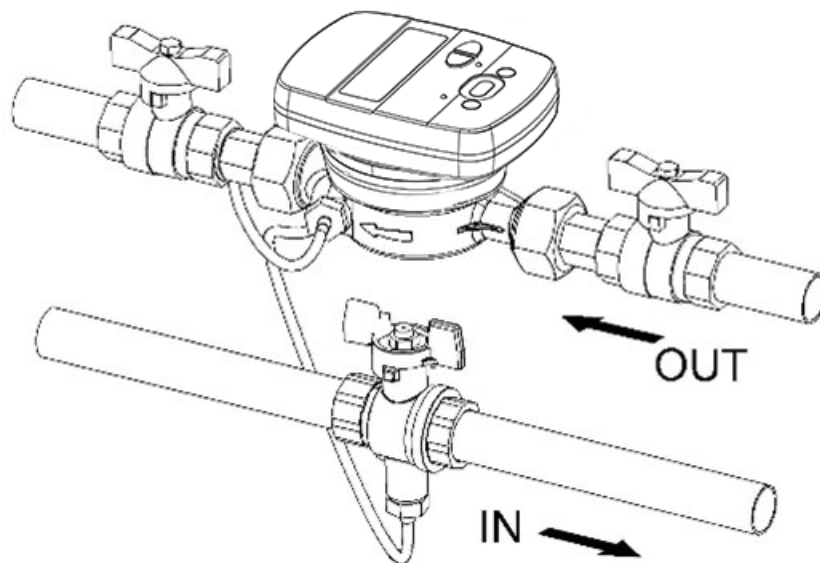

ALLOWED INSTALLATION POSITIONS

All versions of the thermal energy meter can be installed both horizontally and vertically. For a better performance it is preferable, however, the horizontal installation with the turbine axis perpendicular to the ground and the reading mechanism facing upwards.

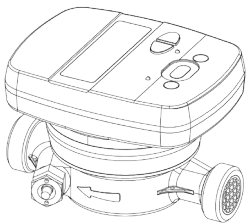

Ideal position
for a better performance

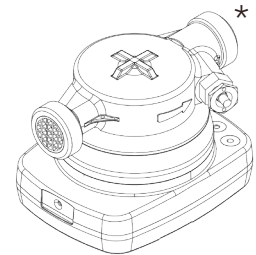
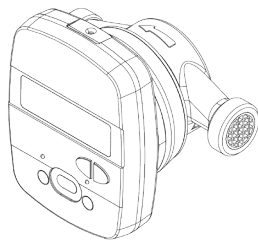

Additional allowed positions

* This position is not suggested for cooling meters and in cases where moisture can enter the electronic casing due to condensation (e.g. during an interruption of the plant in the summer)

TEMPERATURE SENSOR INSTALLATION

The thermal energy meter is equipped with two digital probes that comply with the **MID 2014/32/EC** directive and the **EN1434** standard.

→ For a correct installation, always proceed in compliance with the directives prescribed by current regulations.

In the standard version (e.g. mounting on return pipe), the return probe is already incorporated inside the brass case. The supply probe must be installed in a ball valve or in a socket mounted on the flow pipe and complies with the requirements of the sensor itself.

Vice versa, the version for installation on the inlet pipe the probe inserted inside the brass case will be the flow, the return probe will need to be installed in a valve or a socket on the return pipe.

 Before installing the 'free' probe (the one not inserted in the meter case), it is necessary to intercept the flow (close the ball valve or the appropriate shutters).

INSTALLATION IN A SOCKET

1. Screw the socket in the pipe
2. Insert the temperature sensor
3. Tighten the screw

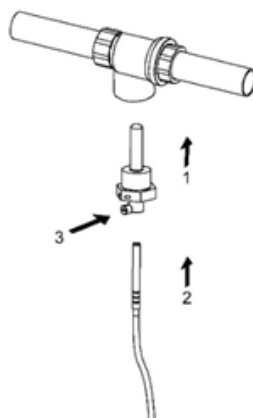

BALL VALVE INSTALLATION

1. Insert the probe into the threaded nut
2. Insert the closing pin
3. Unscrew the valve closing screw, and place appropriate seals
4. Insert the probe by screwing it on the threaded guide

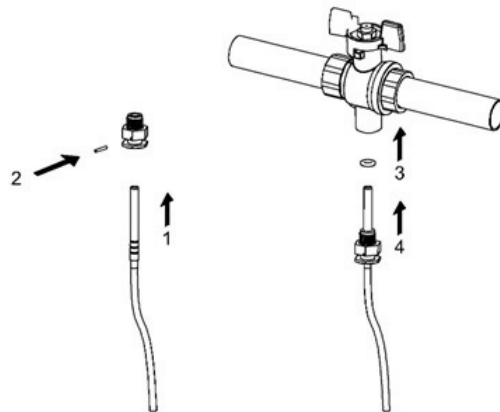

- For a correct temperature measurement, the tip of the probe must be in the center of the pipe. In addition, the axis of the probe must be perpendicular to the pipe axis (see figure).
- The temperature sensor must be sealed when the installation is complete.



4. Functionality

The **HYDROCAL-M4** thermal energy meter is equipped with dedicated sections for the measurement of thermal energy of a heating/cooling circuit and the volume measurement given by the domestic hot and cold-water meters. The meter is suitable for domestic applications with two-pipe systems, in a thermal power plant or any other compatible application.

In residential systems, usually with two pipes systems, the measurement of thermal energy takes place on a single section both in heating and cooling cycle.

The picture below reports a typical connection diagram:

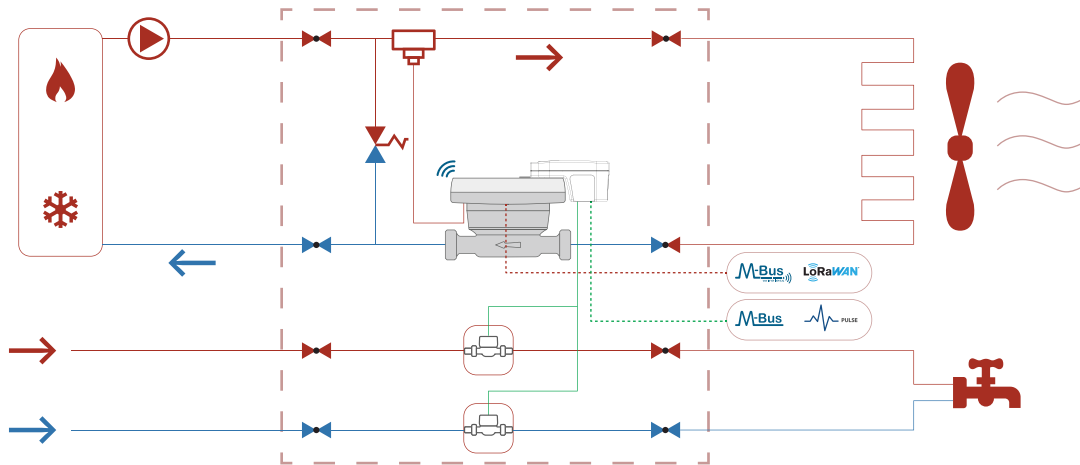

5. Display and buttons

The device is equipped at the front with an LCD and two buttons (T1 and T2), useful for device initialization and readings

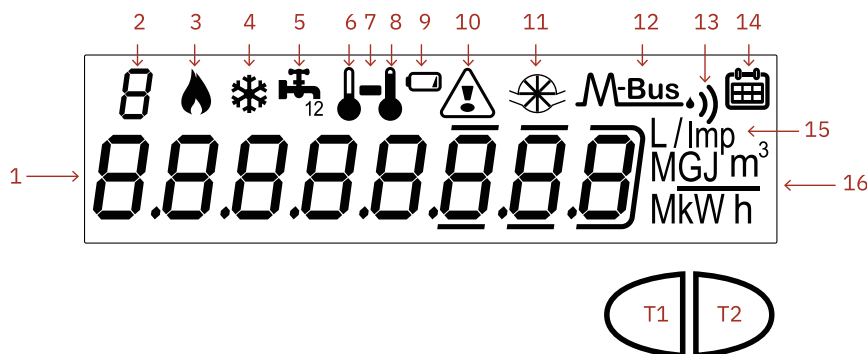

- | | | | |
|-----|--|--------|--|
| 1) | Eight-digit numeric field; | 12+13) | M-Bus Wireless data index; |
| 2) | Single-digit numeric index (menu level); | 13) | LoRaWAN communication data index; |
| 3) | Heating data index; | 14) | Historical index; |
| 4) | Cooling data index; | 15) | Pulse value index (k); |
| 5) | Circuit 1-2 pulse emitter (external module); | 16) | Measurement unit index; |
| 6) | Return temperature index; | T1) | Levels selection button; |
| 7) | Indicator of sub level presence | T2) | Scroll button within the selected level; |
| 8) | Supply temperature index; | | |
| 9) | Battery level indicator; | | |
| 10) | Faults or NFC/IR active communication indicator; | | |
| 11) | Flow presence indicator; | | |
| 12) | M-Bus wired communication data index; | | |

6. Commissioning

⚠ The first configuration chosen during installation (supply or return pipe) can't be modified!

Premise: before a functional tests, the procedures indicated in this paragraph must be performed for completing the physical installation phases including the connections.

The device is delivered in sleep mode. Based on the order, if the installation version and the unit of measurement are already configured, it is necessary to keep T2 button pressed for three seconds to initialize the device.



If a choice has not been made during the order, the meter must be configured. The configuration of the meter can be performed via buttons or via NFC through android app. If the activation takes place with buttons, the items in the menu will be two:

1. Installation version: select, through the left/right button (T1/T2), the type of installation (supply or return). Holding down the right button for 3 seconds can temporarily confirm the choice made by switching to level 2 (unit of measurement). If the T1 button is pressed for 3 seconds the thermal energy meter will return to stock mode showing 'SLEEP' on display.
2. Units of measurement: select through the left/right button (T1/T2), one of the following items, ordered as described below:

- 1 (Joule)
- 2 (MJ)
- 3 (GJ)
- 4 (KWh)
- 5 (MWh)

By pressing for 3 seconds the right T2 button you can confirm the choice made by passing directly to the initialization of the device. By pressing the T1 button for 3 seconds the thermal energy meter will return to installation version mode showing 'set Mode' on display. After confirmation in step 2 the thermal energy meter will perform the initialization for heating and cooling accounting. The unit of measurement can be changed later via NFC.

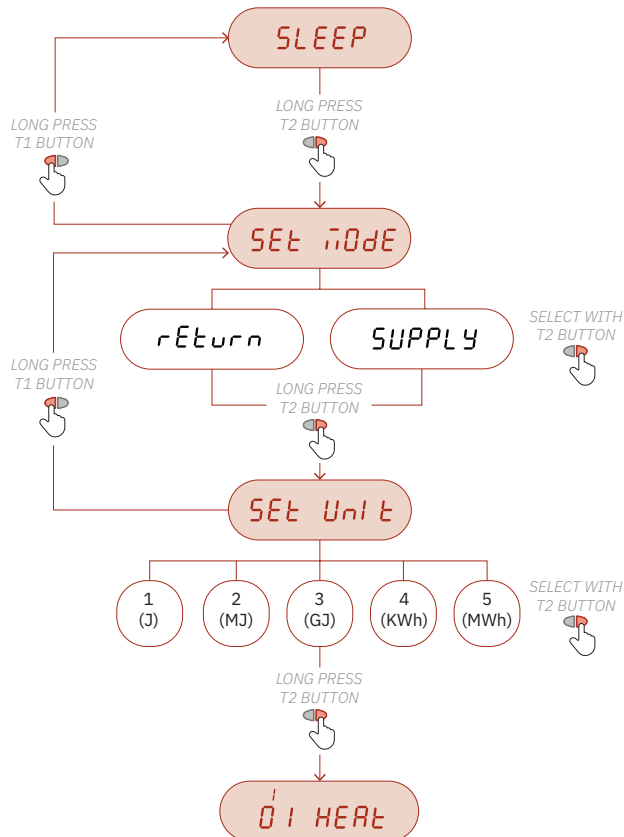

User configuration data can be configured via NFC device and NFC app.
Below the list of data available:

- All averages values (temperatures, flow rates, etc) are saved every hour.
- The biweekly and monthly historical data, present in level 6, are saved at each occurrence (default: day 1, end of month). if the configured days are the same (example: day 15 or leaving the default values) the data are saved as 'monthly' and therefore will be stored in memory up to 24 previous historical months.
If two different dates are selected (example: day 15 for bimonthly historical data and day 1 for monthly historical data) a maximum of 48 values are stored in the device (including 24 previous historical monthly values and 24 previous historical bimonthly values). The range of days selectable are between 1 and 28.
- The bi-annual historical data (memory day 1 and 2), present in level 4, are saved and displayed with the format DD/MM/D1 and DD/MM/D2 (where Dx indicates the year of saving).
Default: 01/09 for memory day 1 and 30/06 for memory day 2. The range of days/month selectable are between 1..28 (days) and 1..12 (months).

PROCEDURE FOR COMMISSIONING

- 1) Check that the mounting position of the thermal energy meter and all electrical wiring are carried out correctly
- 2) Check if the device is configured, otherwise set the installation version and the unit of measurement
- 3) Check at level 3 that all configured parameters are correct (heating and cooling data)
- 4) Check that the thermal energy meter, pulse devices, probes etc. are installed correctly (refer to the specific installation manuals for each product)
- 5) Start the heating/cooling system:
 - Check the consistency of the reported values (energy and volume)
 - Check in level 2 the instant data
- 6) Check for errors
- 7) Apply installation seals. Apply installation seals. It's recommended to lock the device with a password set through the BMETERING NFC Config android app (downloadable from the Google Play Store).

7. Consultation menu

→ Displayed data are only for examples

The consultation menu is divided into 9 levels by a numerical index always visible at the top left of the display. By pressing the T1 button you can choose the desired level, while pressing the T2 button you can view the sublevels of the preset level.

After 60 seconds without iteration the display turns off. If no button is pressed within 20 seconds (with the display off) the display cycle will start again from level 1. If a button is pressed within 20 seconds (with the display off) the last level consulted will be displayed.

In any level or sublevel, holding down the T1 button for 3 seconds will direct the index to level 1.

To access to a sublevels, where present (indicate by the symbol '-'), it is necessary to hold down the T2 button for 3 seconds. To return to a main level from a sublevel it's necessary to hold down the T2 button again for 3 seconds.

Each level consists of a brief indication in letters of the data that will be shown after a few seconds in a second screen. Specifically, the cycle will be defined as follows:

- (First consultation): 2,5 seconds the indication in letters and 5,5 seconds the data
- (2-n consultations): 1 second according to the indication in letters and 6 seconds the data

NOTE: In absence of historical data, levels 6-7-9 will show - - (text).

Below, the navigation map of the consultation menu is shown.



LEVEL S1: INITIALIZATION

In this level, based on the order, the configuration of the thermal energy meter (installation version and unit of measurement) is already managed. NFC communication it is disabled in this sleep phase.

Note: it's necessary to holding down the T2 button for 3 seconds for the thermal energy meter initialization.

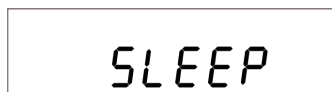

The device is in sleep mode, waiting for T2 long press



Meter initialization, level 1 (Cumulative energy heating)

LEVEL S2: CONFIGURATION AND INITIALIZATION

→ To configure the device please refer to 'COMMISSIONING' paragraph

In this level, the configuration of the thermal energy meter is managed through buttons before its installation. The "not Set" condition remains active only until no other condition has been selected. When the condition is changed (by pressing T1 or T2) it will no longer appear. Through NFC it is possible to set unit and installation version. If the parameters are not set via NFC, the device remains in 'not set' mode.



The device is in sleep mode, waiting for configuration via buttons or NFC

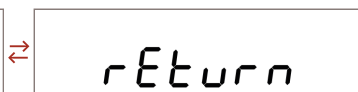
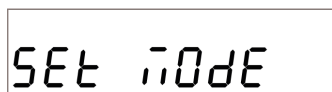

Installation version (return, supply)



Units of measurement
(1=Joule, 2=MJ, 3=GJ, 4= kWh, 5=Mwh)



Meter initialization, level 1 (Cumulative energy heating)

LEVEL 1: CUMULATIVE VALUES



1.1 Cumulative energy (heating) – Cumulative value





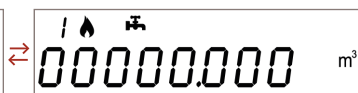









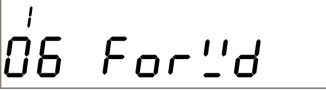

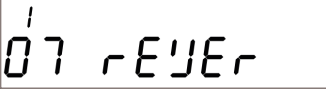
1.2 Cumulative energy (cooling) – Cumulative value





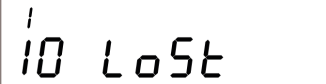















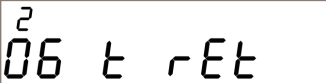

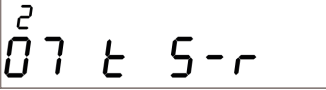

1.3 Volume useful for accounting (heating) – Cumulative value

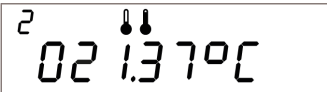

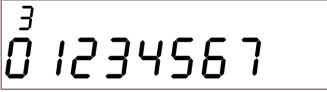
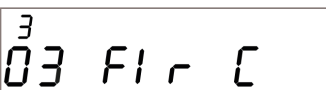
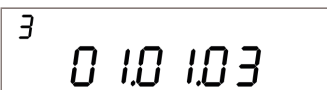
		1.4 Volume useful for accounting (cooling) – Cumulative value
		1.5 Total accounted volume (heating and cooling) – Absolute value
		1.6 Forward accounted volume (heating and cooling) – Cumulative value
		1.7 Reverse volume accounted (heating and cooling) – Cumulative value
		1.8 Total value (first additional impulse input) – Cumulative value [value visible only if enabled]
		1.9 Total value (second additional impulse input) – Cumulative value [visible only if enabled]
		1.10 Lost volume (heating and cooling) – Cumulative value

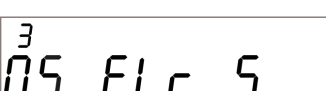
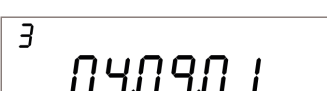
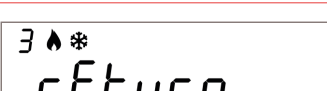
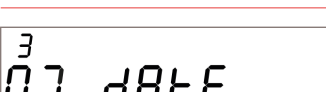
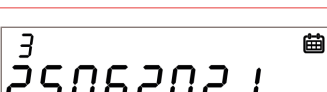
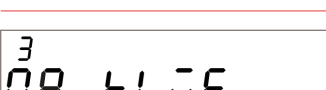
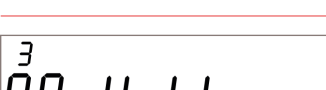

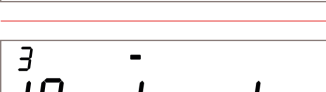



LEVEL 2: INSTANTANEOUS OPERATING VALUES

		2.1 Actual power (kW)
		2.2 Instantaneous power (W) – given per second
		2.3 High resolution energy (heating) – extension value of 1.01 level
		2.4 Actual flow rate
		2.5 Supply temperature
		2.6 Return temperature



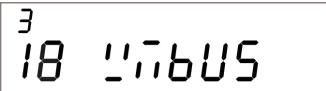
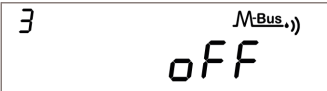

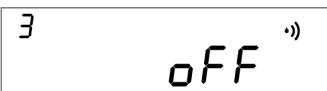

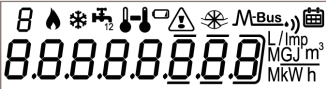

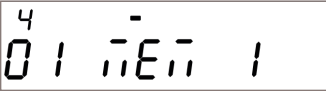

		2.7 Temperature difference
		2.8 CPU temperature (approximately ±3°C accuracy)
LEVEL 3: SETTINGS (DISPLAYING ONLY)		
		3.1 Serial number
		3.2 CRC Calculation firmware (legal part)
		3.3 Calculation Firmware Version (legal part)
		3.4 Radio Communication Firmware Version (Non-Legal Part)
		3.5 Radio Stack Firmware Version (Non-Legal Part)
		3.6 Installation version (return or supply)
		3.7 Current date
		3.8 Current time
		3.9 Unit of measurement (1= Joule, 2=MJ, 3=GJ, 4= kWh, 5 Mwh)
		3.10 Pulse Input 1 (on, off)
		3.10.1 Liters/pulse ratio - additional pulse input 1

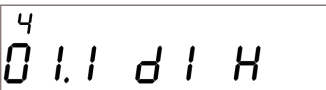
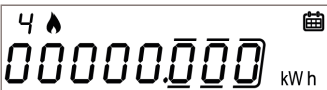

3 10.2 StAr	↔	3 00000000 m ³	3.10.2 Initial input value - additional pulse input 1
3 10.3 nEd1	↔	3 01	3.10.3 Medium - additional pulse input 1
3 11 in 2	↔	3 off	3.11 Pulse Input 2 (on, off)
3 11.1 rAt1	↔	3 0000 1000 L/Imp	3.11.1 Liters/pulse ratio - additional pulse input 2
3 11.2 StAr	↔	3 00000000 m ³	3.11.2 Initial input value - additional pulse input 2
3 11.3 nEd1	↔	3 01	3.11.3 Medium - additional pulse input 2
3 12 nbus	↔	3 on M-Bus	3.12 MBUS interface (on, off)
3 12.1 Pri	↔	3 Addr=01 M-Bus	3.12.1 MBUS primary address (heating and cooling)
3 12.2 SEC	↔	3 0 1234567 M-Bus	3.12.2 MBUS secondary address (heating and cooling)
3 12.3 bPS	↔	3 bPS 9600 M-Bus	3.12.3 Baud rate MBUS (300, default: 2400, 9600)
3 13 nEn 1	↔	3 DAY 31	3.13 Monthly historical save day (default 01)
3 14 nEn 2	↔	3 DAY 01	3.14 Biweekly historical save day (default 01, biweekly disabled)
3 15 ddnn 1	↔	3 dn 0 102	3.15 Day and month saving (Memory day 1)
3 16 ddnn 2	↔	3 dn 0 101	3.16 Day and month saving (Memory day 2)

 	3.17 Day and month saving (Annual historical data)
 	3.18 WMBUS mode (AMR, Walk-by, AMR Custom, Off)
 	3.19 LoRa interface (on, off)
 	3.20 Display test – All segments on and all segments off (repeat every 2 seconds)

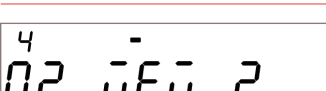
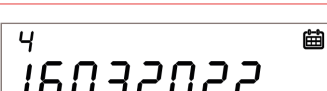
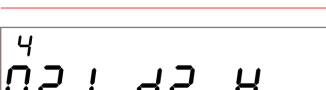
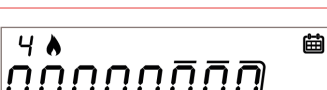
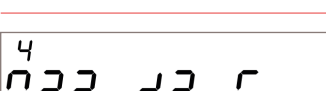
LEVEL 4: STORAGE DAY DATA 1-2

 	4.1 Memory 1 date of storage
 	4.1.1 Heating – cumulative value Memory 1
 	4.1.2 Cooling – cumulative value Memory 1
 	4.1.3 Additional first impulse input consumption – cumulative value Memory 1
 	4.1.4 Consumption according to additional impulse input – cumulative value Memory 1
 	4.2 Memory 2 date of storage
 	4.2.1 Heating – cumulative value Memory 2
 	4.2.2 Cooling – cumulative value Memory 2



4
02.3 d2 1 ↔ 4 000000000 m³

4.2.3 Additional first impulse input consumption – cumulative value Memory 2

4
02.4 d2 2 ↔ 4 000000000 m³

4.2.4 Consumption according to additional impulse input – cumulative value Memory 2

LEVEL 5: COUNTER DATA

5
01 LIFE ↔ 5 0023.19.21 h

5.1 Total hours of device life (DDDD.HH.MM)

5
02 FLIFE ↔ 5 0003.19.19 h

5.2 Total counting hours (DDDD.HH.MM)

5
03 HFor! ↔ 5 0003.00.00 h

5.3 Total counting hours - heating (DDDD.HH.MM)

5
04 CFor! ↔ 5 0000.19.19 h

5.4 Total counting hours - cooling (DDDD.HH.MM)

5
05 FFor! ↔ 5 0000.15.13 h

5.5 Total counting hours with flow and without a difference of temperature (DDDD.HH.MM)

5
06 noErr ↔ 5 0003.19.19 h

5.6 Total counting hours without errors (DDDD.HH.MM)

LEVEL 6: MONTHLY/BIWEEKLY HISTORICAL DATA

6
01 bi nty ↔ 6 16.03.2022

6.1 Date of storage of the monthly history (up to 24 possible values). Default: save at the end of the month, biweekly historical data disabled.

6
01.1 HEAT ↔ 6 000000000 kWh

6.1.1 Accounted energy (heating) – cumulative value at monthly historical data

6
01.2 Cool ↔ 6 000000000 kWh

6.1.2 Accounted energy (cooling) – cumulative value at monthly historical data

6
01.3 In 1 ↔ 6 000000000 m³

6.1.3 Accounted impulse input 1 – cumulative value at monthly historical data

		6.1.4 Accounted impulse input 2 – cumulative value at monthly historical data
		6.1.5 Average supply temperature – average value at monthly historical data
		6.1.6 Average return temperature – average value at monthly historical data
		6.1.7 Average ambient temperature – average value at monthly historical data
		6.1.8 Average power (Kw) – average value at monthly historical data
		6.1.9 Average flow rate (m3/h) – average value at monthly historical data

LEVEL 7: ANNUAL HISTORICAL DATA

		7.1 Date of storage of the annual history (up to 12 possible values). Default: save at the end of the year
		7.1.1 Accounted energy (heating) – cumulative value at annual historical data
		7.1.2 Accounted energy (cooling) – cumulative value at annual historical data
		7.1.3 Accounted impulse input 1 – cumulative value at annual historical data
		7.1.4 Accounted impulse input 2 – cumulative value at annual historical data
		7.1.5 Average supply temperature – average value at annual historical data
		7.1.6 Average return temperature – average value at annual historical data



⁷ 0 1.7 Err	↔	⁷ 000000°C	7.1.7 Average ambient temperature – average value at annual historical data
---------------------------	---	--------------------------	---

⁷ 0 1.8 AvgP	↔	⁷ 000000000 kW	7.1.8 Average power (Kw) – average value at annual historical data
----------------------------	---	------------------------------	--

⁷ 0 1.9 AvgF	↔	⁷ 000000000 m ³ /h	7.1.9 Average flow rate (m3/h) – average value at annual historical data
----------------------------	---	---	--

LEVEL 8: ERRORS AND ANOMALIES

⁸ 0 1 A Err	↔	⁸ 0000	8.1 Number of active errors
---------------------------	---	----------------------	-----------------------------

⁸ 0 2 Err 0 1	↔	⁸ Err 26	8.2 Displaying Active Errors
-----------------------------	---	------------------------	------------------------------

LEVEL 9: ERROR LOG

⁹ 0 1 Log E	↔	⁹ Err 17off	9.1 Active error logs (up to 32 possible values)
---------------------------	---	---------------------------	--

⁹ 0 1.1 date	↔	⁹ 25.06.2021	9.1.1 Date of error storage
----------------------------	---	----------------------------	-----------------------------

⁹ 0 1.2 time	↔	⁹ 18.40.47	9.1.2 Time of error storage
----------------------------	---	--------------------------	-----------------------------

⁹ 0 1.3 cnt	↔	⁹ 000000000	9.1.3 Total count error occurrences
---------------------------	---	---------------------------	-------------------------------------

8. Operating mode – Radio activation

This section describes the radio communication management implemented.

For the WM-Bus interface there is a test mode that can be activated via NFC (only before the passage of +- 5 liters), that allows to verify the correct functioning of the device. With an NFC command the WM-Bus interface will be enabled for 1 minutes sending standard transmission data every 5 seconds. After this cycle the thermal energy meter will return to the initial mode waiting for the passage of +- 5 liters.

RADIO PARAMETERS

Wireless MBUS - OMSv4 compliant (output configuration Wireless MBUS only)

As soon as radio operation mode is activated, the thermal energy meter sends a radio telegram according to Wireless MBUS, T1 mode (unidirectional and synchronous transmission).

Preconfigured Radio parameters (AMR and synchronous mode, OMSv4 compliant):

- Transmission frequency: every 200 seconds (current values)
- Transmission interval: every day, from 0 to 24 h
- Encryption: disabled (default)
- No historical data
- Transmitted data: standard data (heating energy, heating volume), errors, battery value as a percentage

It is possible to change the configuration into Walk-By or Advanced mode with BMetering NFC Config app:

- Transmission frequency: configurable (minimum 60 seconds)
- Transmission interval: from Monday to Friday (optional Weekend), maximum 12 hours per day
- Possibility to select a 24-hours' time span with the following mandatory conditions:
 - Transmission frequency: > 300 seconds (synchronous)
 - Historical data disabled
- Encryption: enabled/disabled
- Historical data (12 months)
- Transmitted data:
 - Standard data (max. 13 bytes): heating energy, heating volume
 - Combined (max 28 bytes): standard data with the addition of optional cooling energy and cooling volume
 - Instantaneous (max. 31 bytes): standard data with the addition of optional instantaneous data
 - Pulses (max. 31 bytes): standard data with the addition of optional data regarding pulse input 1 and 2 (if used)
 - Battery value as a percentage
 - Errors
 - Historical data:
 - 6 months of heating energy
 - 12 months of heating energy
 - 6 months of heating energy and 6 month of cooling energy
 - 12 months of heating energy and 12 month of cooling energy
 - 12 months of heating energy and 12 months of heating volume
 - 12 months of cooling energy and 12 months of cooling volume
 - 6 months of heating energy and 6 months of pulse 1 - 2
 - 6 months of heating energy and 6 months of cooling energy + 6 months of pulse 1 - 2

The transmission of the packets will take place according to the default schedule or chosen by the customer via NFC. An ordered schedule is provided based on the selected WM-Bus packets (default: standard packet every 200 second of transmission). If the transmission is < 200 seconds, the transmission will be asynchronous otherwise synchronous.

LoRaWAN (output configuration LoRaWAN only) – Available soon



RADIO INDICATOR ON DISPLAY



During the JOIN to the network procedure, if the LoRaWAN transmission has been activated, the radio symbol will flash quickly on the display (at a period of 1 second) until the device reaches the JOINED state and then remains always active. In the case of a failed JOIN the radio symbol turns off.

In the case of wM-BUS mode only after switching +/- 5 liters the  icon will remain permanently active.

In the case of wired M-Bus mode only after switching +/- 5 liters the  icon will remain permanently active.

The radio icon  will flash quickly during a transmission (LoRaWAN or wM-Bus) in cases where the device has reached the JOINED state or when only wM-Bus mode is active.

During the wM-Bus and/or LoRaWAN test procedures, after starting the procedure via NFC app, the following cases will be handled:

- WMBUS_TEST_MSG: the icon  will remain active for 1 minutes and will flash quickly on the display (at a period of 1 second) with each wM-Bus package sent. After that time the icon will turn off.
- LORA_TEST_JOIN: the radio icon  will start flashing quickly on the display (at a period of 1 second). If the join operation was successful, the icon will remain stable for 1 minute and then turn off otherwise it will continue to flash until all join attempts are concluded. In the case of a forced join procedure, after the passage of +/- 5 liters, the icon will flash throughout the 6 minutes cycle to various SFx and then remain on or off depending on the outcome of the join request.

9. Errors and faults

When one or more anomalies occur, the thermal energy meter will report the recorded error and show the following icon on the display . If the NFC or IR interface is used, the icon will blink for the duration of the communication. The register of all the anomalies present is shown at level 8 of the consultation menu, where the abbreviation Ern followed by two digits identifies the anomaly.



The indication of error codes that are disabled by default (**) can be enabled during the production phase of the thermal energy meter or later via NFC. The following is a list of all error codes:

Error	Name	Description
01**	Loss	The device detects a continuous flow of $>0.5 \cdot Q1$ for 12 hours (default). The alarm resets when the average flow in 5 minutes is below the above threshold. Temporary error, resets automatically when a flow interruption happens.
02**	Burst	If the flow rate of the meter remains continuously above $Q3$ for 30 minutes, the alarm is set. The alarm automatically resets when the flow rate decreases below $0,5 \cdot Q3$.
03	Qmax Overflow	The error is triggered after the device operates at a flow rate greater than $Q4$ for 10 consecutive minutes. Permanent error, the alarm can be reset via NFC or LORA.
04**	Reverse flow	The error is triggered after a continuous reverse flow of more than 20 liters. Permanent error, the alarm can be reset via NFC or LORA.
05**	No consumption	The error is triggered when the flow is not detected for 7 consecutive days. The alarm automatically resets when flow is detected.
06	Reverse installation	During first installation only, if the absolute counting (forward counter - reverse counter) is equal to 0 and a reverse flow (>10 Liters) is detected, the alarm turns on. The alarm automatically resets when flow is on the correct direction.
07**	Qmin Underflow	The error is triggered after the device operates at a flow rate less than $Q1$ (and greater than the start) for 10 consecutive minutes. Temporary error, resets automatically when the initial condition is restored.
08	Reserved	Inform Customer Service
09	Reserved	Inform Customer Service
10	Reserved	Inform Customer Service
11	End of battery life	The error is triggered when the remaining life of the Hydrocal-M4 battery is less than 1 year. Permanent error, the icon  is shown on display.
12	Probe failure	Failure, short circuit or tampering on supply or return probe(s). On display, in level 2, 'Error' will be shown on the screen of the relevant damaged probe(s). Permanent error, Inform Customer Service.
13	Reserved	Inform Customer Service
14	Reserved	Inform Customer Service

Error	Name	Description
15	Reserved	Inform Customer Service
16	Reserved	Inform Customer Service
17	Wrong Real Time Clock	The error is recorded when a sudden reset of date and time is detected. Permanent error, the alarm can be reset via NFC or LORA.
18	Supply Measurement out of range	Measurement of the supply probe over the measuring range. Temporary error, resets automatically when the initial condition is restored.
19	Return Measurement out of range	Measurement of the return probe over the measuring range. Temporary error, resets automatically when the initial condition is restored.
20**	Incorrect installation	The error occurs when the probes/device are installed in reverse. Detection takes place for 10 consecutive minutes. Temporary error, resets automatically when the initial condition is restored The error appears when the following conditions occur: <ul style="list-style-type: none"> → Device version only 'Heating' (installation on return and supply version): (Temperature difference) supply - return temperature > 0 → Combined device version 'Heating and Cooling': <ul style="list-style-type: none"> - (Temperature difference) supply temperature < 15 °C and return temperature > 3°C - (Temperature difference) supply temperature > 40 °C and return temperature > -2.2 °C → Negative with cooling disabled: occurs after 10 minutes with continuous active flow, and the temperature difference is negative
21	Delta T non-compliant	The error occurs when for 24 continuous hours without flow and Delta T (temperature difference) > 10°C. Temporary error, resets automatically when the initial condition is restored.
22**	Delta T too low	The error occurs when for 10 consecutive minutes with flow > 0 the delta T is less than the start (1 °C for heating, 0.2 °C for cooling).
23**	Delta T too high	The error occurs when for 10 consecutive minutes with flow > 0 the delta T (heating) > +50 °C or delta T (cooling) >40. Temporary error, resets automatically when the initial condition is restored.
24**	Excessive temperature	The error is triggered when an ambient temperature > +85°C is detected. Temporary error, resets automatically when the ambient temperature is < +80 °C
25	Display Overflow	The error is triggered when the energy digits, based on the selected unit, go further the maximum possible display. Permanent error, the alarm can be reset via NFC or LORA.
26	Reserved	Inform Customer Service
27	Reserved	Inform Customer Service
28**	No C1 consumption	The error is activating when no pulses are detected for 7 consecutive days on the C1 pulse input. The alarm automatically resets when a pulse is detected.
29**	No C2 consumption	The error is activating when no pulses are detected for 7 consecutive days on the C1 pulse input. The alarm automatically resets when a pulse is detected.
30**	Loss on C1	The device detects continuous pulses on C1 for 12 hours. Temporary error, resets automatically when a pulse interruption happens.
31**	Loss on C2	The device detects continuous pulses on C2 for 12 hours. Temporary error, resets automatically when a pulse interruption happens.

Error	Name	Description
32**	Too frequent pulses C1	The error is triggered when too frequent pulses are detected on C1. Temporary error, resets automatically when the initial condition is restored.
33**	Too frequent pulses C2	The error is triggered when too frequent pulses are detected on C2. Temporary error, resets automatically when the initial condition is restored.
34**	Too frequent MBUS readings	The error is triggered when too many MBUS queries are made under the minimum limit of 15 minutes. Temporary error, resets automatically when the initial condition is restored.
35	MBUS disconnected	The error is triggered when MBUS communication is not detected for 2 consecutive hours. Temporary error, resets automatically when the initial condition is restored.
36	Wrong module	The error is triggered when the external module has been removed and a second module is mounted. Permanent error, the alarm can be reset via NFC or LORA.
37	Module removal	The error is triggered when the module is not detected for 5 consecutive failed communications. Permanent error, the alarm can be reset via NFC or LORA.
38	End of battery life module	The error is triggered when the remaining battery life of the external module is less than 1 year. Permanent error.
39	Reserved	Inform Customer Service
40	NFC Fraud	The error is triggered when an NFC field is detected for more than some minutes. Permanent error, the alarm can be reset via NFC or LORA.



10. Battery and replacement procedures

The thermal energy meter constantly monitors the status of the battery (**maximum life: 10 years***) and signals the imminent discharge by showing the icon on display . Reporting takes place one year before full discharge.

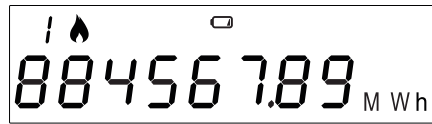











***The battery life strongly depends on the working time window, set during the configuration process, and on the environmental conditions. Estimation of the battery life is given by the configuration software.**

For replacement, contact the manufacturer.



The thermal energy meter uses non-rechargeable batteries that, if misused, can be potentially dangerous. To reduce the risks, you should take the following precautions:

	Do not recharge or replace the battery;
	Do not open, puncture or damage the batteries;
	Do not short-circuit the battery;
	Do not expose the battery to temperatures above 85° C;
	Do not insert into ovens, crush or cut: these actions could cause an explosion or leakage of flammable gases or liquids;
	Do not use naked flames near the device;
	Do not put in contact with water;
	Do not expose the battery to an extremely low pressure environment which could cause an explosion or a leak of gases or flammable liquids;
	<u>Always dispose of batteries in compliance with current regulations;</u>
	Always use original spare parts authorized by the manufacturer.

11. Thermal energy meter - Technical Data

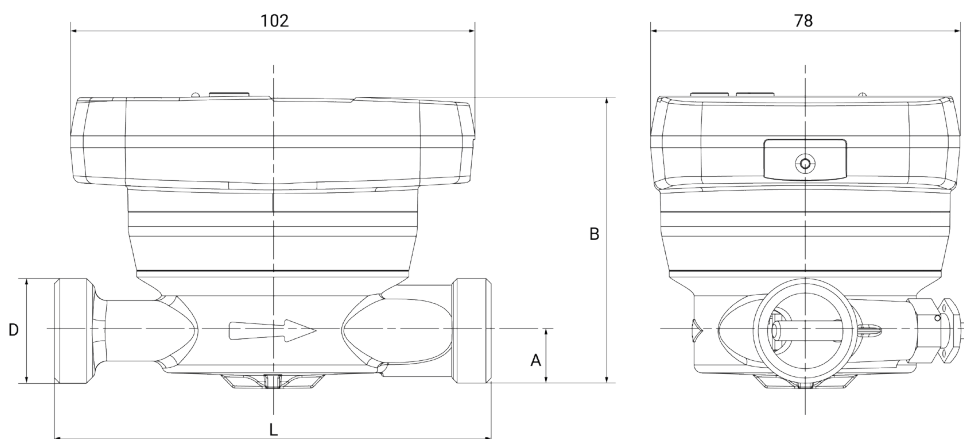

Diameter	L	A	B	D
DN15 (1/2")	110 mm	13 mm	72 mm	3/4"
DN20 (3/4")	130 mm	17 mm	76 mm	1"

Model	Hydrocal M4			
Power supply	Battery-powered			
Battery type	Lithium, 2 x 2.7 Ah, 3.0V			
Battery life	Maximum 10 years			
Range temperatures use	+5 - +55°C			
Storage temperature range	-20 - +70°C			
Dimensions	110 x 78 x 73 mm (DN15); 130 x 78 x 76 mm (DN20)			
Weights	575g (DN15); 700g (DN20)			
Degree of protection	IP65			
Approval	2014/32/EC MID (Module B) EN1434			
Environmental class	A (E1, M1)			
Measurement temperature range (heating)	Θ : +1 °C - +90°C			
Temperature range difference (heating)	$\Delta\Theta$: 3 K - 90 K			
Measuring temperature range (cooling)*	Θ : +0.2 °C - +90°C			
Temperature range difference (cooling)*	$\Delta\Theta$: 0.2 K - 90K			
Accuracy class	2			
qp\ qi ratio Depending on the diameter and the nominal flow rate	Size	qp (m ³ /h)	Ratio	qi (l/h)
	DN15	0.6	50:1	12
	DN15	1.5	50:1**	30
	DN20	2.5	50:1**	50

* The thermal energy calculation for heating application is MID certified.
The cooling energy calculation is not compliant with the MID regulation.

**On request 100:1



Counting operating conditions (start)	Heating: $\Delta\theta \geq 1K$ (counting enabling conditions) Cooling: $\Delta\theta \geq 0.2K$
Maximum measurable power	650 kW
Display	LCD, 8 digits + icons
Units of measurement	J, MJ, GJ, kWh, MWh
Temperature probes	Digital
Probe cable length	1.5 m free probe, 1 m internal probe
Pulse input	2 for impulsive device (external module)
Pulse input class	Class IA (default): Open Collector or electromagnetic contact (reed).
Max. pulse input frequency	5 Hz
Max. cable length pulse input devices	3 m
Installation	Selectable by the customer, supply or return on request.
Liquid supported	Water

12. Information for the correct disposal of the product



This product falls within the scope of Directive 2012/19/EU on the management of waste electrical and electronic equipment (WEEE). The appliance should not be disposed of with household waste as it is composed of different materials that can be recycled at the appropriate facilities. Inquire through the municipal authority regarding the location of the ecological platforms suitable for receiving the product for disposal and its subsequent correct recycling. The product is not potentially dangerous to human health and the environment, but if abandoned in the environment it negatively impacts the ecosystem. The symbol of the crossed-out bin, present on the label placed on the appliance, indicates the compliance of this product with the legislation on waste electrical and electronic equipment. The abandonment of the equipment in the environment or the abusive disposal of the same are punishable by law.

13. Head Loss Curve

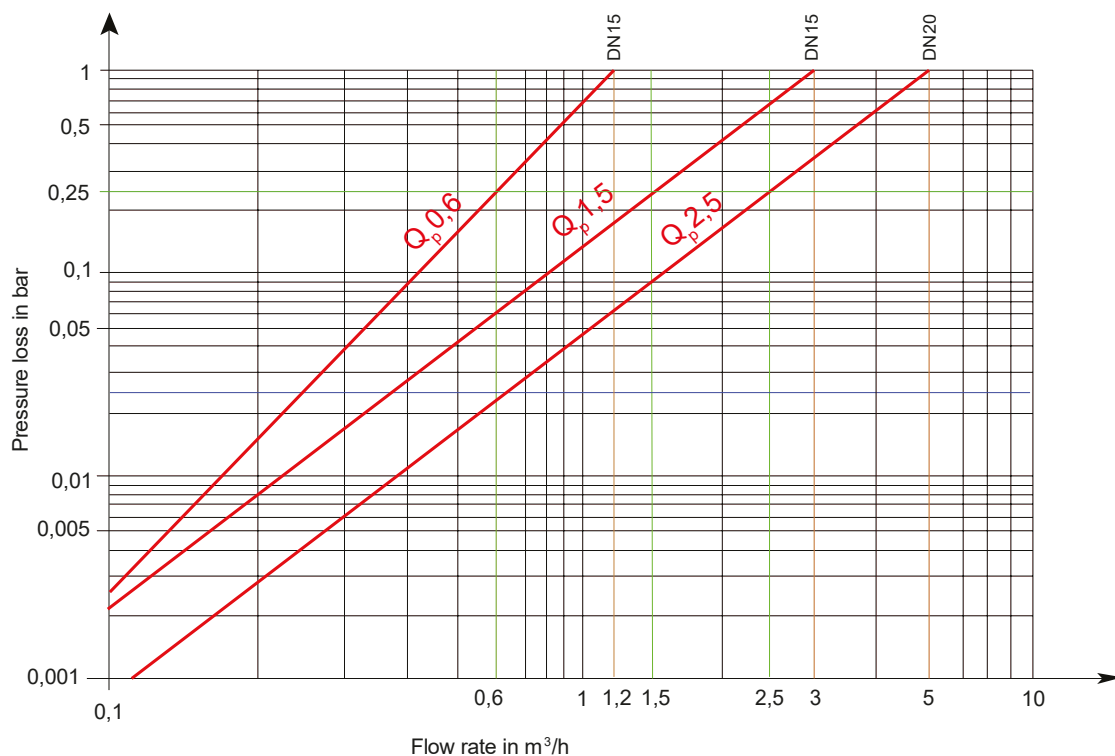

14. Quick menu scheme

1	INDEX	INF	UM
↳	1.01	HEAT	J, MJ, GJ, kWh, MWh
	1.02	COOL	J, MJ, GJ, kWh, MWh
	1.03	HEAT	m ³
	1.04	COOL	m ³
	1.05	ABSOLUTE	m ³
	1.06	FORWARD	m ³
	1.07	REVERSE	m ³
	1.08	IN 1	m ³
	1.09	IN 2	m ³
	1.10	LOST	m ³

2	INDEX	INF	UM
↳	2.01	POWER H	KW
	2.02	POWER S	W
	2.03	HEAT	J, Wh
	2.04	FLOW	m ³ /h
	2.05	TEMP. SUPPLY	°C
	2.06	TEMP. RETURN	°C
	2.07	TEMP.DIFFERENCE	°C
	2.08	TEMP. AMBIENT.	°C

3	INDEX	INF	UM
↳	3.01	SERIAL NUMBER	
	3.02	CRC FW	
	3.03	MAIN FW	
	3.04	RADIO FW	
	3.05	DISPLAY FW	
	3.06	INSTALL TYPE	RETURN, SUPPLY
	3.07	DATE	
	3.08	TIME	
	3.09	UNIT	1,2,3,4,5
	3.10	IN 1	ON, OFF

INDEX	INF	UM
3.10.1	PULSE RATE	Type of pulse
3.10.2	START VALUE	Type of pulse
3.10.3	MEDIUM	Type of pulse
INDEX	INF	UM
3.11.1	PULSE RATE	Type of pulse
3.11.2	START VALUE	Type of pulse
3.11.3	MEDIUM	Type of pulse
INDEX	INF	UM
3.12.1	PRIMARY ADDRESS	
3.12.2	SECONDARY ADDRESS	
3.12.3	BAUD RATE	BPS

INDEX	INF	UM
3.11	IN 2	ON, OFF

INDEX	INF	UM
3.12	MBUS	ON, OFF

INDEX	INF	UM
3.13	MONTHLY SAVE DAY	
3.14	BIWEEKLY SAVE DAY	
3.15	DATE SAVE MEM1	
3.16	DATE SAVE MEM2	
3.17	DATE SAVE ANNUAL	
3.18	WMBUS TYPE	WALK-BY, AMR, AMR CUSTOM, OFF
3.19	LORAWAN	ON, OFF
3.20	DISPLAY TEST	

4	INDEX	INF	UM
	4.01	MEMORY DAY 1	



4.02	MEMORY DAY 2	
------	--------------	--



INDEX	INF	UM
4.01.1	HEAT	J, MJ, GJ, kWh, MWh
4.01.2	COOL	J, MJ, GJ, kWh, MWh
4.01.3	IN 1	Type of pulse
4.01.4	IN 2	Type of pulse
INDEX	INF	UM
4.02.1	HEAT	J, MJ, GJ, kWh, MWh
4.02.2	COOL	J, MJ, GJ, kWh, MWh
4.02.3	IN 1	Type of pulse
4.02.4	IN 2	Type of pulse

5	INDEX	INF	UM
	5.01	METER LIFE	h
	5.02	START COUNTING	h
	5.03	HEATING HOURS	h
	5.04	COOLING HOURS	h
	5.05	NO DELTA HOURS	h
	5.06	NO ERRORS HOURS	h



6	INDEX	INF	UM
	6.xx*	MONTHLY MEMORY 1	



xx* incremental index

INDEX	INF	UM
6.xx.1	HEAT	J, MJ, GJ, kWh, MWh
6.xx.2	COOL	J, MJ, GJ, kWh, MWh
6.xx.3	IN 1	Type of pulse
6.xx.4	IN 2	Type of pulse
6.xx.5	AVERAGE FLOW TEMP	°C
6.xx.6	AVERAGE RETURN TEMP	°C
6.xx.7	AVERANGE AMB TEMP	°C
6.xx.8	AVERAGE HEAT	W
6.xx.9	AVERAGE FLOW	m³/h

7	INDEX	INF	UM
	7.xx*	ANNUAL MEMORY	



INDEX	INF	UM
7.xx.1	HEAT	J, MJ, GJ, kWh, MWh
7.xx.2	COOL	J, MJ, GJ, kWh, MWh
7.xx.3	IN 1	Type of pulse
7.xx.4	IN 2	Type of pulse
7.xx.5	AVERAGE FLOW TEMP	°C
7.xx.6	AVERAGE RETURN TEMP	°C
7.xx.7	AVERANGE AMB TEMP	°C
7.xx.8	AVERAGE HEAT	W
7.xx.9	AVERAGE FLOW	m³/h

8	INDEX	INF	UM
	8.01	Active errors	
	8.xx*	Errors code	



9	INDEX	INF	UM
	9.xx*	LOG mem errors	



INDEX	INF
9.xx.1	Error data
9.xx.2	Error time
9.xx.3	Error count

EU Declaration of conformity

CE.HYDROCALM4. 2022.04.29

We **BMeters S.r.l.**
Noi **Via Friuli, 3**
I-33050 Gonars (UDINE)

Declare under our sole responsibility that the product(s)
Dichiariamo sotto la nostra responsabilità che il/i prodotto(i)
Hydrocal M4

According to type examination certificate no. 035-22-2213 from April 29nd, 2022, issued by the Pa.L.Mer. institute, identification number 2213,
Come dal certificato di esame del tipo n. DE-16-M-PTB-0001 del 22 Aprile 2022, rilasciato dall'istituto Pa.L.Mer., numero di identificazione 2213,

To which this declaration relates is\are in conformity with requirements of the following directive(s):

Al\ai quale\i questa dichiarazione si riferisce è\sono conforme(i) ai requisiti della\le seguente(i) direttiva(e):

- **2014/53/EU Radio Equipment (RED)**
- **2014/30/EU EMC directive**
- **2014/32/EU Measuring Instrument Directive (MID)**
- **2011/65/EU Restriction of the use of certain hazardous substances (RoHS)**

The conformity was checked in accordance with the following harmonized EN standard(s):
La conformità è stata verificata in conformità alla\alle seguente\i norma\le europee:

EN 300-220-2 V3.2.1

Short Range Devices (SRD) operating in the frequency range 25 MHz to 1000 MHz;

EN 1434-1:2015+A1:2018

Thermal energy meters - Part 1: General requirements

EN 1434-2:2015+A1:2018

Thermal energy meters - Part 2: Constructional requirements

EN 1434-4:2015+A1:2018

Thermal energy meters - Part 4: Pattern approval tests

EN 1434-5:2015+A1:2018

Thermal energy meters - Part 5: Initial verification tests

Welmec 7.2 Rev.5



B METERS S.r.l.
GONARS, 29 April 2022

Mauro Budai
General Manager



Contacts

B METERS srl

Via Friuli, 3 • Gonars 33050 (UD) • ITALY

Tel: +39 0432 931415

Tel: +39 0432 1690412

Fax: +39 0432 992661

E-mail (sales/info): info@bmetrics.com

E-mail (support): ticket@bmetrics.com

Web: www.bmetrics.com

