



ISO 9001:2015
ISO 14001:2015
ISO 45001:2018
ISO 50001:2018

www.tuv.com
ID 9105067711

**Kotao
na BIOMASU/
BIOMASS
heating
boiler**

**UNI 20 / UNI
20 PLUS**



INSTRUKCIJE / INSTRUCTION MANUAL

Montaža, korišćenje i održavanje kotla / *Assembly, use and maintenance of heating boiler*

Sadržaj

1. Važna upozorenja.....	2
1.1. Minimalna udaljenost od zapaljivih materijala	3
2. Opis <i>UNI 20</i> kotla	4
3. Montaža.....	5
3.1. Opšta upozorenja	5
3.2. Mere i uređaji bezbednosti kod <i>UNI 20</i> kotla	6
3.3. Radni prostor i pozicioniranje <i>UNI 20</i> kotla	9
3.4. Montaža <i>UNI 20</i> kotla na dimnjak	10
4. Presek <i>UNI 20</i> kotla sa opisom elemenata.....	14
5. Šema povezivanja automatike.....	15
6. Tabela sa tehničkim podacima	16
7. Hidraulička šema.....	17
8. Start rada <i>UNI 20</i> kotla i održavanje.....	19
8.1. Displej automatike.....	19
8.2. Kratko uputstvo za korisnika automatike	21
8.3. Start rada <i>UNI 20</i> kotla.....	27
8.4. Greške prilikom startovanja i u toku rada <i>UNI 20</i> kotla.	29
8.5. Održavanje i čišćenje <i>UNI 20</i> kotla.....	34
8.6. Natpisna pločica	36
9. Garancija	37

1. Važna upozorenja

Opšta upozorenja

- Nakon uklonjenog pakovanja uveriti se u kompletnost isporuke, i u slučaju nedostataka, obratiti se prodavcu koji je prodao kotao.
- Kotao mora biti upotrebljen isključivo za namenu koju je predvideo proizvođač. Isključuje se bilo kakva odgovornost od strane proizvođača za štetu uzrokovanu osobama, životinjama ili stvarima, u slučaju grešaka pri montaži, regulaciji, održavanju ili nepravilnom korišćenju.
- U slučaju curenje vode isključiti uređaj sa električnog napajanja, zatvoriti napajanje vodom i obavestiti ovlašćeni servis ili ovlašćenog montera.
- Ovo uputstvo je sastavni deo uređaja i mora se čuvati sa pažnjom i mora **UVEK** pratiti uređaj i u slučaju promene vlasnika ili korisnika ili u slučaju priključenja na drugu instalaciju. U slučaju oštećenja ili nestanka tražiti novi primerak od ovlašćenog prodavca.

Pelet kotao je generator toplote koga čini mehanički deo u kome je voda pod pritiskom, ali i dosta elektro komponenti koje su pod naponom. U ovakvim uređajima gde je mogućnost kontakta vode i elektro komponenti velika, zahteva se poštovanje sledećih opštih i posebnih sigurnosnih mera:

- Zabranjeno je korišćenje pelet kotla od strane dece i osoba sa ograničenim mogućnostima bez pratnje.
- Zabranjeno je korišćenje pelet kotla na instalacijama sa radnim pritiskom većim od **2.5 bara** i radnom temperaturom većom od **85°C**.
- Ovaj uređaj je proizvođač toplotne energije kako preko vode tako i direktnim putem, emisijom u okolni prostor. Zbog toga postoje površine koje su tako zagrejane da kontaktom mogu da stvore ozbiljne povrede. Prilikom rada sa tim površinama koristiti zaštitna sredstva. Posebno voditi računa da deca ne dolaze u direktni kontakt sa uređajem.
- Zabranjena je bilo kakva intervencija tehničkog lica ili čišćenje od strane korisnika dok se uređaj ne odvoji od mrežnog napajanja izvlačenjem utičnice iz zidnog priključka.
- Zabranjena je izmena sigurnosnih elemenata. Zamenu ovih delova zbog neispravnosti uraditi uz saglasnost ovlašćenog tehničkog lica od strane proizvođača tj. Radijator inženjeringa ili kontaktirati direktno proizvođača.
- Zabranjeno je izlaganje pelet kotla atmosferskim neprilikama. Ovaj uređaj nije predviđen za spoljnu montažu.
- Zabranjeno je isključivanje uređaja ukoliko spoljna temperatura može da padne ispod nule po Celzijusu (opasnost od smrzavanja).
- Zabranjeno je stavljanje prstiju i drugih predmeta kroz otvore na spoljnim delovima oplate uređaja. Unutar oplate su elektro komponente i provodnici pod naponom kao i

uređaji koji se mehanički pokreću (motor reduktor i ventilator). Kontakt sa njima može da dovede do strujnog udara i mehaničkih povreda.

- Zabranjeno je instalirati uređaj u samoj blizini zapaljivih materijala, naročito obratiti pažnju na materijal koji izoluje kotla od poda. On mora biti nezapaljiv i određenih dimenzija. Pogledati odeljak “Montaža”.
- Pelet kotao se ne sme prekrivati, niti se na njemu ili uz njega smeju nalaziti bilo kakvi predmeti.
- Za rad pelet kotla potrebno je dovesti svež vazduh (videti u odeljku Montaža). Prostoriju u kojoj se kotao nalazi provetravati više puta u toku dana.
- Zabranjen je istovremeni rad prinudne ventilacije (na primer kuhinjski aspirator) i pelet kotla u istoj prostoriji. Ovo može dovesti do slabog rada uređaja, ali i do curenja ugljenik monoksida koji može da izazove čovekovo gušenje.

1.1. Minimalna udaljenost od zapaljivih materijala

- Obezbedite odgovarajuću udaljenost od zapaljivih materijala, ako je potrebno obezbediti zaštitu istih.
- Minimalna udaljenost od zapaljivih materijala je propisana zakonom- molimo da se o tome raspitate kod stručnih lica, koja se bave grejanjem, i dimnjačara.
- Minimalna udaljenost kotla i cevi za odvod dimnih gasova od slabo i prosečno gorivih materijala treba da bude najmanje 100mm.
- Minimalno rastojanje od lako zapaljivih materijala je 200 mm, a isto važi i za materijale čija zapaljivost nije poznata.

⚠ Opasnost od požara!

- Skladištenje zapaljivih materijala i tečnosti u blizini kotla je zabranjeno.
- Obavezno upozorite korisnike o potrebnoj minimalnoj udaljenosti zapaljivih materijala od kotla.

Zapaljivost građevinskih materijala	
A ... nezapaljivi	azbest, kamen, građevinski kamen, keramičke zidne pločice, terakota, malter, cementna glazura (bez organskih dodataka)
B ... koji nisu lako zapaljivi	gipsane kartonske ploče, staklena vlakna, ploče od AKUMINA, IZOMINA, RAJOLITA, LIGNOSA, VELOKSA i HERAKLITA
C1 ... slabo gorivi	bukovo i hrastovo drvo, kompozitno drvo, filc, ploče od HOBREKSA, VERZALITA, UMAKARTA
C2 ... prosečno gorivi	drvo bora, tise i jele, kompozitni materijali
C3 ... lako zapaljivi	Asfalt, karton, celulozni materijali, iverica, pluta, poliuretan, polistiren, polipropilen, polietilen, podna vlakna

2. Opis *UNI 20* kotla

UNI 20 kotao je namenjen zagrevanju prostora, zagrevanjem vode za radijatorsko grejanje, u kotlovskom delu.

Kotao se sastoji iz sklopova čije su osnovne komponente obavezne da se isporučuju u standardnoj verziji:

- Kotlovski deo sa turbulatorima i dimovodnim kanalima, silos sa dozererom, spoljna oplata, vrata sa termoizolacijom.
- Displej, ploča automatike, motor-reduktor pelet transportera, ventilator dimnih gasova, sigurnosni presostat dimnih gasova, senzor temperature vode u kotlu, senzor temperature dimnih gasova, senzor protoka vazduha u kotlu i ostala elektro oprema.

Komponente hidro instalacije koje je potrebno namontirati na kotao ili na sistem grejanja su: cirkulaciona pumpa, ekspanzion posuda (min 20 litara), ventil sigurnosti na pritisak, odzračno lonče, slavina za punjenje i pražnjenje izmenjivača.

Drveni pelet se dobija od 100% celuloze. Ostaci drveta pod visokim pritiskom su sabijeni u pelet prečnika 6mm i dužine 2-3 cm. Pelet treba pravilno skladištiti i to na suvom mestu da bi se obezbedilo efikasno sagorevanje. Kotao *UNI 20* koristi pelet prečnika 6mm, dužine 5-30mm i vlažnosti do 10% izrađen po standardu **EN 14962-2**.

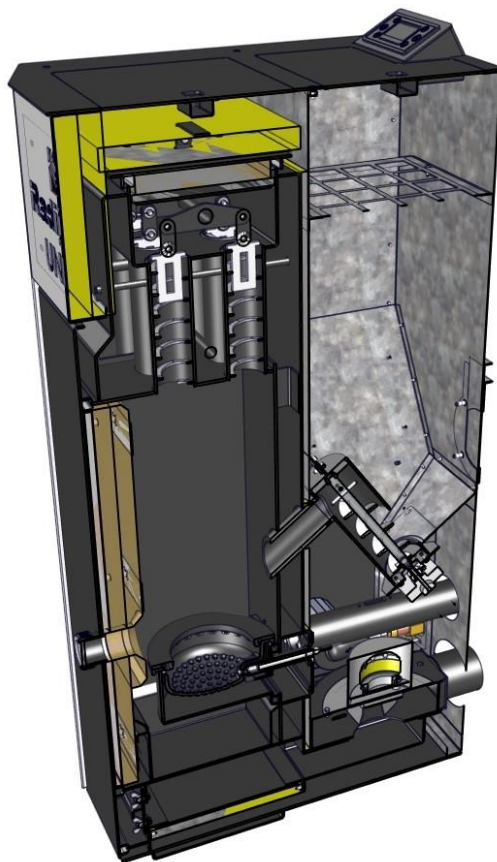

Slika 1. Poprečni presek UNI 20 kotla

3. Montaža

3.1. Opšta upozorenja

Kotao mora biti pravilno postavljen zbog pravilnog rada!

- ⚠ UNI 20 kotao je predviđen za rad na instalacijama centralnog grejanja radnog pritiska do 2,5 bara i maksimalne radne temperature 85 stepeni Celzijusa.**
- ⚠ Vrata na kotlu moraju biti zatvorena za vreme rada kotla.**
- ⚠ UNI 20 kotao je sa ventilatorom, automatikom i motorom i svi uređaji koriste napajanje 230V, tako da nepravilno instaliranje i neoprezno rukovanje mogu da ugroze ljudski život strujnim udarom.**
- ⚠ Kao gorivo koristiti samo pelet.**
- ⚠ Pri instaliranju kotla, njegovu težinu uzeti u obzir.**
- ⚠ Prilikom montaže pridržavati se zakonskih normi i propisa predviđenih za montažu kotla na drveni pelet sa generatorom tople vode, a koji važe u zemlji u kojoj se uređaj montira. U suprotnom Radijator inženjering kao proizvođač ne preuzima odgovornost za posledice takve montaže.**
- ⚠ Ukoliko neka promena na konstrukciji, naročito na sigurnosnim uređajima dovede do neželjenih posledica koje mogu da naruše čovekovo zdravlje, pa i život, Radijator inženjering ne preuzima odgovornost.**
- ⚠ Uređaj mora da radi sa potpuno ispravnim svim sigurnosnim uređajima koji su navedeni i opisani u narednom tekstu. Dimni kanali moraju da budu čisti i bez oštećenja. Sigurnosne uređaje servisirati samo uz konsultaciju sa ovlašćenim licima od strane proizvođača ili kontaktirati direktno proizvođača.**

Radijator inženjering, kao proizvođač kotla, ne preuzima nikakvu odgovornost za štete prouzrokovane lošim instaliranjem kotla.

****Sve nacionalne i lokalne regulative i Evropski standard se moraju ispuniti prilikom instalacije kotla.***

3.2. Mere i uređaji bezbednosti kod *UNI 20* kotla

Za bezbedan rad *UNI 20* kotla ugrađeni su sledeći elementi i potrebno ih je održavati ispravnim:

- Elektro-mehanički presostat za vazduh;
- Presostat dimnih gasova;
- Sigurnosni termostat.

Za bezbedan rad *UNI 20 PLUS* kotla ugrađeni su sledeći elementi i potrebno ih je održavati ispravnim:

- Elektro-mehanički presostat za vazduh;
- Presostat dimnih gasova;
- Sigurnosni termostat.
- Ventil sigurnosti na pritisak;
- Automatsko odzračno lonče;

Elektro-mehanički presostat za vazduh (Slika 1): Služi za regulaciju sagorevanja goriva tokom rada uređaja.



Slika 1 Elektro-mehanički presostat za vazduh

Presostat dimnih gasova (Slika 2): Služi da meri pritisak gasova u ložištu. U slučaju da niste dobro zatvorili neki od poklopaca (prilikom čišćenja ili sl.), ili niste dobro zatvorili vrata, ili je u toku rada kotla nestalo silosu peleta u silosu, uređaj u tom slučaju pokreće gašenje kotla i izbacuje grešku (ER 02). To je još jedan vid mere bezbednosti rada kotla.



Slika 2. Presostat dimnih gasova

- Ovakvi uslovi mogu da dovedu do lošeg odvođenja produkata sagorevanja, naročito ugljenik monoksida što može u ekstremnim situacijama da dovede do narušavanja zdravlja čak i zagušenja korisnika.

Sigurnosni termostat pelet kotla (Slika 3):

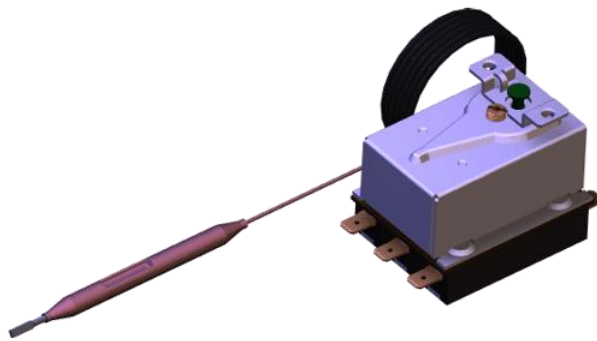

Slika 3. Sigurnosni termostat

Sigurnosni termostat ima sigurnosne funkcije kao limitator temperature vode u kotlu. Ovaj termostat je tzv. radni i on služi da ograniči temperaturu do nivoa koji želi korisnik. Sigurnosna temperatura je ograničena na 103 stepeni Celzijusa. Ovaj termostat je fizički namontiran sa zadnje strane kotla, i strujno je vezan sa automatikom.

Za bezbedan rad **UNI 20** kotla potrebno je ugraditi sledeće elemente i potrebno ih je održavati ispravnim (**ne dolaze uz kotao, za razliku od PLUS verzije**):

- Ventil sigurnosti na pritisak;
- Automatsko odzračno lonče;
- Termomanometar:



Slika 4. Sigurnosni ventil



Slika 5. Odzračno lonče



Slika 6. Termomanometar

- **Ventil sigurnosti na pritisak (Slika 4)** je potrebno namontirati na pelet kotao i nazivnog je prečnika 1/2 cola, baždaren na maksimalno 3 bara. Ovaj sigurnosni element koji spada u grupu limitatora pritiska mora da bude takve konstrukcije da izdrži i kratkotrajna prekoračenja i temperature i pritiska, kao i određen sadržaj glikola u tečnosti za grejanje. Ispusni tj. izduvni deo ventila sigurnosti (ukoliko korisnik želi da je namontira) mora da bude od cevi čiji je prečnik najmanje jednak nazivnom prečniku ispusnog dela ventila. Takođe dozvoljeno je za njegovu izradu koristiti najviše jedan luk radijusa $r > 3d$.
 - Sigurnosni ventil mora posedovati nazivnu pločicu i na njoj sledeće podatke:
 - naziv proizvođača;
 - oznaka tipa sigurnosnog ventila/godina ispitivanja;
 - nazivni protok;
 - podatak za koji toplotni učinak je sigurnosni ventil podešen;
 - najviši pritisak otvaranja tj. 3 bara.
 - Obavezna je provera ispravnosti rada u određenim vremenskim periodima kao i ponovna baždarenja od strane sertifikovanih firmi. Ove obaveze se sprovode u skladu sa zakonom svake zemlje u kojoj je kotao namontiran. Obavezno čuvati pisani dokument o podacima zadnjeg baždarenja sigurnosnog ventila.
 - Na povratnom vodu montirati barem još jedan ventil sigurnosti na pritisak.
 - Zajedno sa ventilom sigurnosti na pritisak u istu sigurnosnu grupu spada i odzračni ventil.
 - **Automatsko odzračno lonče (Slika 5)** mora biti montirano na najvišoj tački kotla i direktno na kotlu bez bilo kakvog cevovoda ili bilo kojih drugih elemenata između. Za ovu svrhu postoji i posebno predviđen priključak. Strogo je zabranjeno bilo kakvo reduciranje prečnika ovog priključka prilikom servisiranja i postavljanja novog.
 - **Termomanometar (Slika 6)** se ugrađuje na hidrauličkoj instalaciji.
- ⚠ Pumpa za grejanje ima veoma važnu bezbednosnu funkciju i potrebno je povezati sa elektro napajanjem preko automatike i iz sigurnosnih razloga. Kada temp. vode u kotlu dostigne kritičnu vrednost od 86 stepeni Celzijusa ventilator staje sa radom, ali pumpa se obavezno uključuje kako bi razmenila toplotu vode kroz radijatore.**

- ⚠ **Montaža slavine za punjenje i pražnjenje se vrši u najnižoj tački sistema. Na samom kotlu postoji priključak za punjenje i pražnjenje. Instalaciju puniti polako kako bi se sistem dobro ozračio. Tokom punjenja instalacije proveriti da nema curenja u sistemu centralnog grejanja.**

3.3. Radni prostor i pozicioniranje UNI 20 kotla

Prilikom određivanja mesta na kome će se pozicionirati kotao treba voditi računa o sledećim detaljima:

- Kotao mora da bude što bliži dimnjaku, takođe dovod svežeg vazduha za sagorevanje treba da bude što bliže.
- Uređaj nikad ne sme biti instaliran u spavaćoj sobi niti u prostoriji koju je nemoguće vratima odvojiti od spavaće sobe.
- U prostoriji u kojoj se montira pelet kotao ne sme biti korišćena još neka peć ili kotao na čvrsto gorivo i pelet. Potrebna cirkulacija vazduha kroz jedan od ovih uređaja najverovatnije će da smeta dotoku vazduha u drugi uređaj.
- Prostorija u kojoj je kotao mora da ima mogućnost provetravanja i mogućnosti povezivanja sa svežim vazduhom ili sa prostorijom koja je povezana sa spoljnim svežim vazduhom. Ovo povezivanje se ostvaruje sa čeličnim nezapaljivim cevima.
- Za rad uređaja potrebno je mrežno napajanje 230V i 50 Hz. Pozicionirati kotao što bliže priključku i tom prilikom izbegavati produžne kablove.
- U slučaju postavljanja kotla na zapaljivim podlogama (parketi, laminati, etisoni, tepisi itd.) obavezno izolovati kotao od takve podloge sa pločom od nezapaljivih materijala (čelik, keramika, izolacioni materijali od keramičkih vlakana, itd.). Takve ploče treba da su gabarita većih od osnove kotla (**Slika 8**).
- Kotao mora biti bezbedno udaljen od lako zapaljivih materijala kao što su drveni i tekstilni delovi nameštaja, zavese, delovi od plastike itd. Udaljenost mora biti barem jedan metar od takvih materijala.
- Udaljenost kotla od čvrstih nepokretnih objekata (zidovi, stubovi, itd.)
 - A - Sa prednje strane minimalno 400 mm.
 - B - Sa bočnih strana mora biti minimalno 400 mm,
 - C - Sa zadnje strane minimalno 200 mm,

Ova udaljenja su potrebna zbog prilaza otvorima za čišćenje, kao i zbog pristupa prilikom servisnih intervencija.

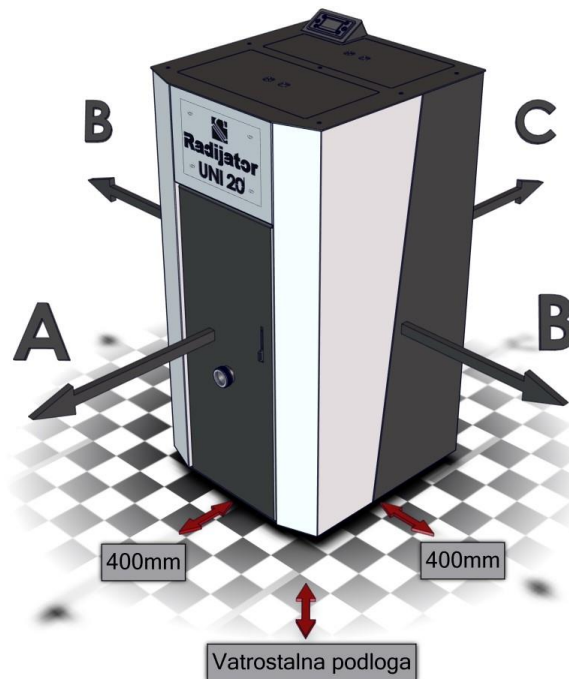

Slika 8. Prikaz udaljenosti kotla od nepokretnih objekata

3.4. Montaža UNI 20 kotla na dimnjak

Prilikom povezivanja pelet kotla sa dimnjakom razlikuju se dve faze montaže i to:

- Montaža dimovodnih kanala i dovod svežeg vazduha za sagorevanje.
- Priključenje na dimnjak.

Montaža dimovodnih kanala i dovod svežeg vazduha za sagorevanje (Slika 9 i 10):

- Za povezivanje pelet kotla sa dimnjakom mora da se koriste specijalne dimovodne cevi koje imaju sertifikate za ovu namenu. Materijali koji se koriste za izradu ovih cevi su konstrukcioni i nerđajući čelici.
- Prečnik dimovodne cevi mora da bude odgovarajući prečniku dimnjače na izlazu, a to je 100 mm. Zabranjeno je reducirati ovaj prečnik.
- Dimovod se ne sme koristiti za više uređaja istovremeno.
- Prilikom montaže dimovoda dozvoljeno je maksimalno dva skretanja dima od 90 stepeni. Maksimalna dužina horizontalnih deonica dimovoda je 2m.
- Ukoliko je dimovod blizu zapaljivih materijala ili prolazi kroz njih (ukrasni sloj zida) obavezno je izolovati ga.
- Dimovodne cevi i elementi namenjeni za priključenje na kotao za pelet najčešće imaju silikonske O prstenove na mestu spajanja. Ovo treba obavezno proveriti pa ako ih nema unapred ugrađenih koristiti silikon ili neki drugi vatrostalni kit za zaptivanje.
- Dimovod mora biti demontažan kako bi se povremeno proverila njegova zaprljanost ili mora da postoji revizioni otvor.

- Ukoliko odvod dima ne ide direktno u dimnjak već vertikalno uvis, potrebno je ugraditi kondenzacioni T komad.
- Dovod vazduha za sagorevanje mora se dovesti sa spoljne strane (iz okoline) i za to koristiti cev napravljenu od crnog ili inox čelika. Najmanji dozvoljeni prečnik ove cevi je 50mm.
- Ukoliko nije moguće dovesti vazduh direktno iz spoljne okoline onda mora biti omogućen dovod iz prostora koji je u direktnom kontaktu sa okolinom. Veza takvog prostora sa okolinom mora biti takva da nije moguće slučajno prekinuti dovod vazduha (zatvaranjem vrata, prozora itd).

Priključenje na dimnjak (Slika 9 i 10)

Prilikom montaže dimnjaka razlikujemo dve situacije:

- **Situacija 1:** Kotao se priključuje na standardni dimnjak (zidani ili metalni) koji ima svoj temelj i pun presek od temeljne ploče do vrha.
- **Situacija 2:** Kotao se priključuje na montažni metalni dimnjak pričvršćen na fasadu.

Situacija 1:

- Kao dimnjak koristiti keramičke ili metalne cevi kružnog poprečnog preseka minimalnog prečnika 130mm. Dimna cev obavezno mora biti izolovana.
- Ukoliko dimnjak već postoji i kvadratnog je poprečnog preseka, onda su minimalne dimenzije tog preseka 130x130mm.
- Nije dozvoljeno koristiti dimnjak za priključenje više uređaja.
- Nije dozvoljeno koristiti ventilacione otvore kao dimnjak.
- Vrh dimnjaka zaštititi dimnjačkom kapom zbog uticaja kiše i vetrova. Rastojanje od kape do dimnjaka 200 mm.
- Dimnjak treba da izađe u odnosu na krov prema preporukama sa slike. (Slika 11). Ukoliko su blizu dimnjaka neki viši objekti uzeti i ovo u obzir i dodatno povećati visinu.
- Dimnjak mora da ima i priključak za izdvajanje kondenza, kao i reviziona vrata. Vrata treba uvek tokom rada dobro da dihtuju.

Situacija 2:

- U ovoj situaciji dimovodna cev mora da ide minimalno 1,5 m vertikalno uvis u samoj prostoriji u kojoj je kotao, a zatim da prođe kroz zid i da se priključi na dimnjak.
- Dimovodna cev mora da ima T kondenzacioni komad na samom izlasku iz kotla kao i mogućnost demontaže zbog čišćenja.

⚠ UPOZORENJE: Nepridržavanje pravila tokom izvođenja dimovodnih kanala i dimnjaka može da dovede do nepravilnog rada kotla, ali i do ugrožavanja zdravlja ljudi pa i njihovih života. Najveća opasnost je od otrovnih gasova koji su

produkti sagorevanja. U ovakvim situacijama gde nisu dimovod i dimnjak, kao i dovod vazduha za sagorevanje odrađeni na način kako je u uputstvu navedeno, Radijator inženjering ne može da preuzme odgovornost za neželjene posledice.

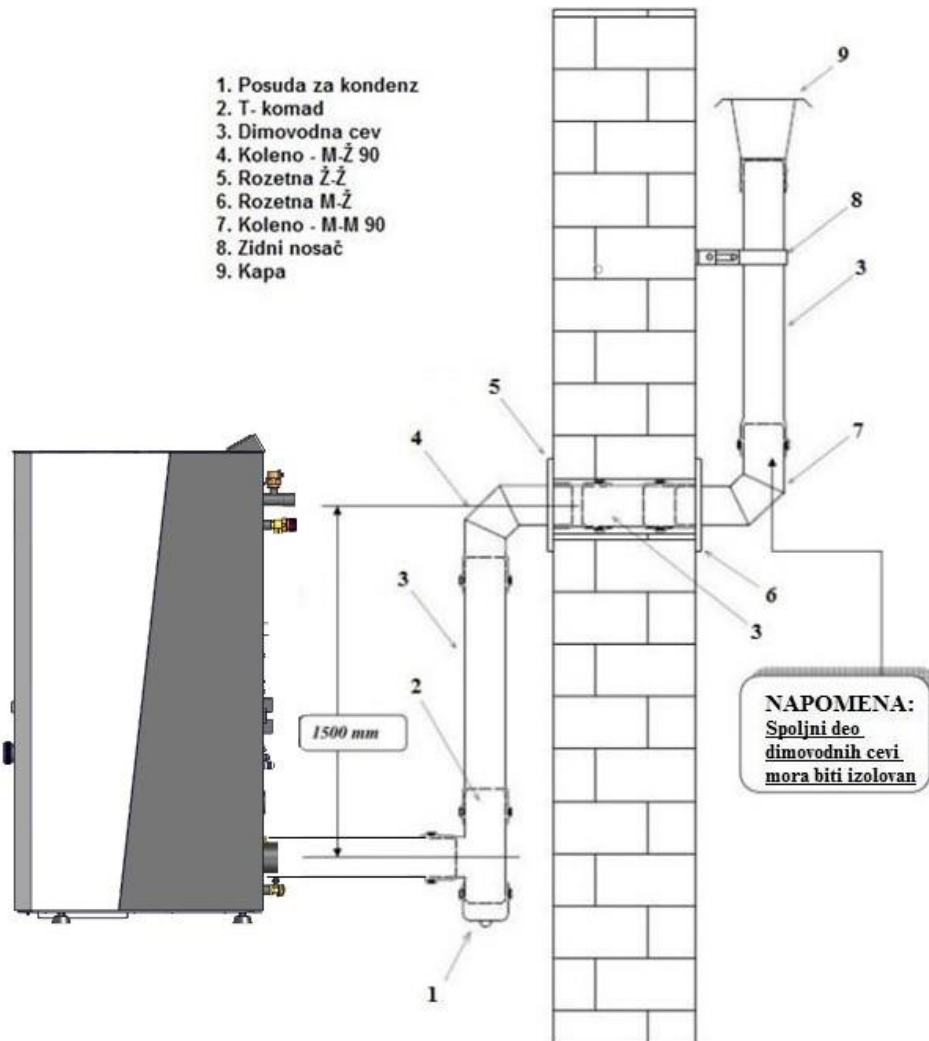

Slika 9. Prikaz montaže dimovodnih kanala

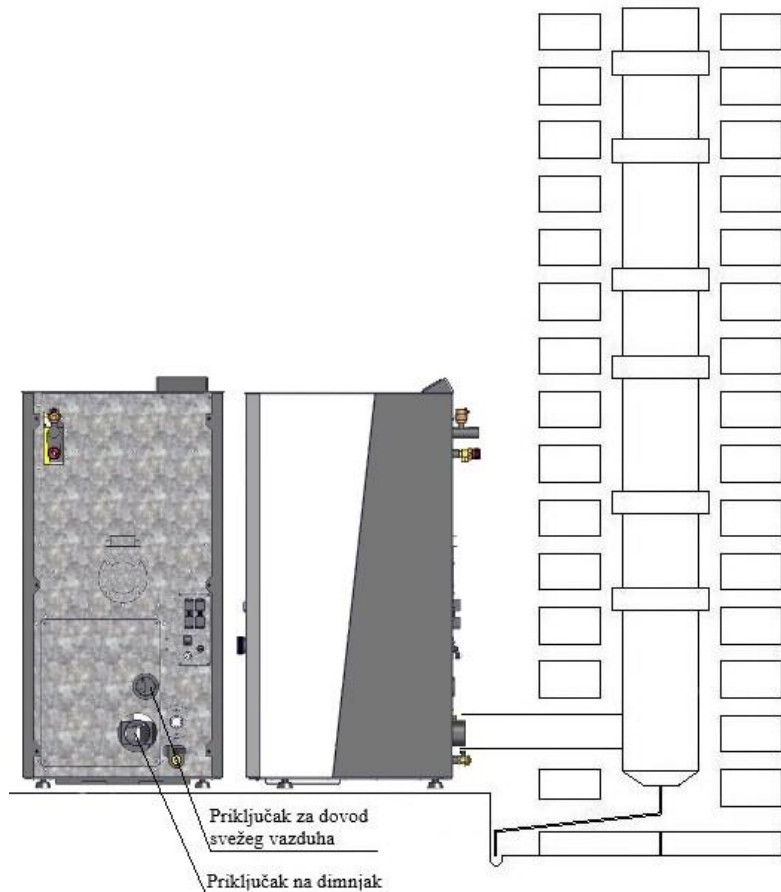

Slika 10. Prikaz priključenja na dimnjak

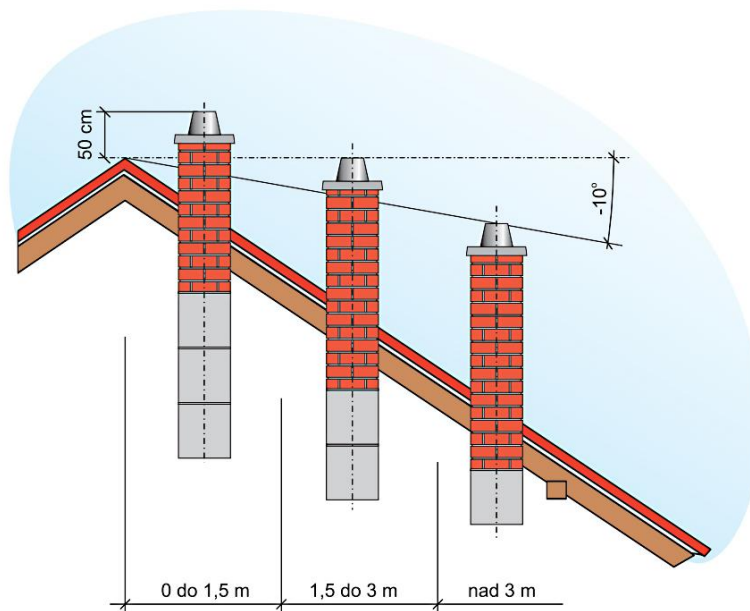

Slika 11. Prikaz –preporuka gradnje dimnjaka

- ⚠ Preporučuje se čišćenje dimnjaka bar jednom godišnje kako bi se smanjio rizik od požara u dimnjaku. Ukoliko dođe do požara zaustaviti rad kotla i pozvati vatrogasce.**

4. Presek *UNI 20* kotla sa opisom elemenata

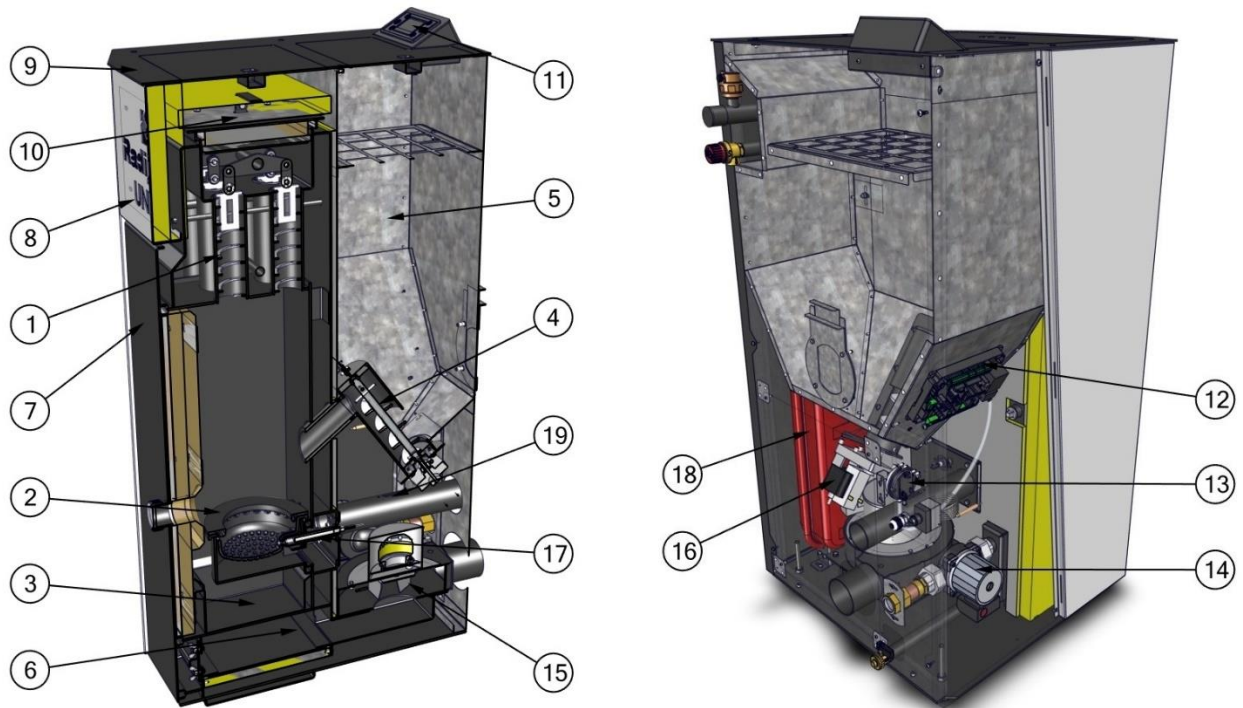

Slika 12. Presek kotla sa opisom elemenata

1. Izmenjivač sa turbulatorima;
2. Šolja za sagorevanje;
3. Pepeljara;
4. Dozator;
5. Silos;
6. Dimovodni kanali;
7. Vrata;
8. Oplata;
9. Plotna;
10. Poklopac izmenjivača;
11. D displej automatike;
12. Procesor automatike;
13. Presostat dimnih gasova;
14. Pumpa (samo u UNI 20 PLUS);
15. Ventilator;
16. Motor dozatora;
17. Grejač;
18. Ekspanziona posuda (samo u UNI 20 PLUS),
19. Senzor protoka vazduha,

5. Šema povezivanja automatike

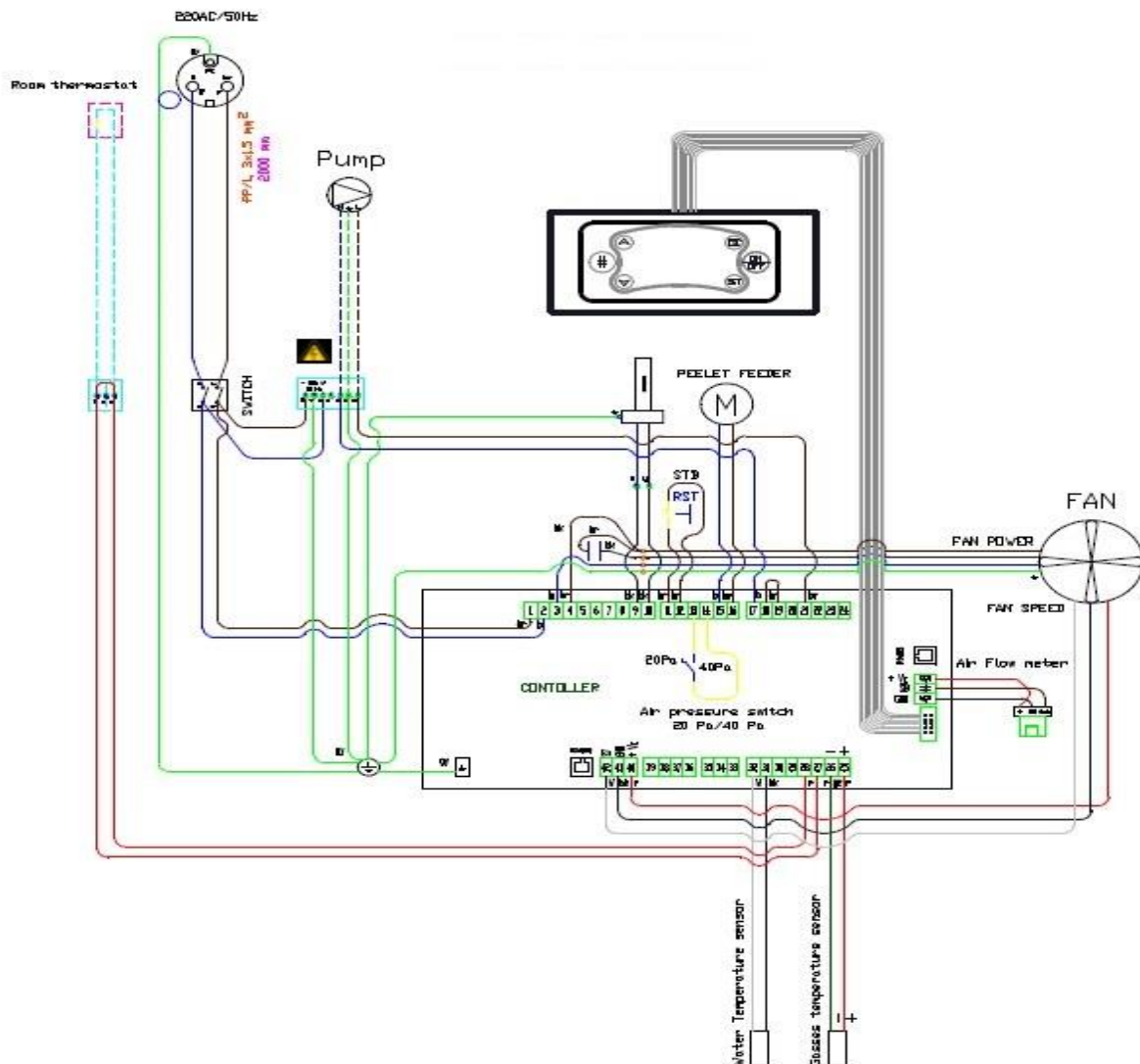

Slika 13. Šema povezivanja automatike

Sve linije koje su prikazane isprekidano na šemi spoljnih priključenja su provodnici koje je potrebno da instalira tehničko lice prilikom priključenja spoljnih uređaja na automatiku kotla. Sva priključenja dodatnih uređaja tehničko lice obavlja preko trolpolnog ili sedmopolnog konektora koja se nalaze na zadnjem delu kotla. Tropolni je za priključenje sobnog termostata što je prikazano na nalepnici samog konektora.Ø

- ⚠ **Za sobne termostate koji se vezuju na trolpolni konektor bitno je da koristite beznaponski kontakt tj. da nemaju na sebi bilo kakav dovod napona 220 V. Na samom termostatu za povezivanje se koristi NC (normalno zatvoreni kontakt bez dovedenog bilo kakvog napona na njega).**

6. Tabela sa tehničkim podacima

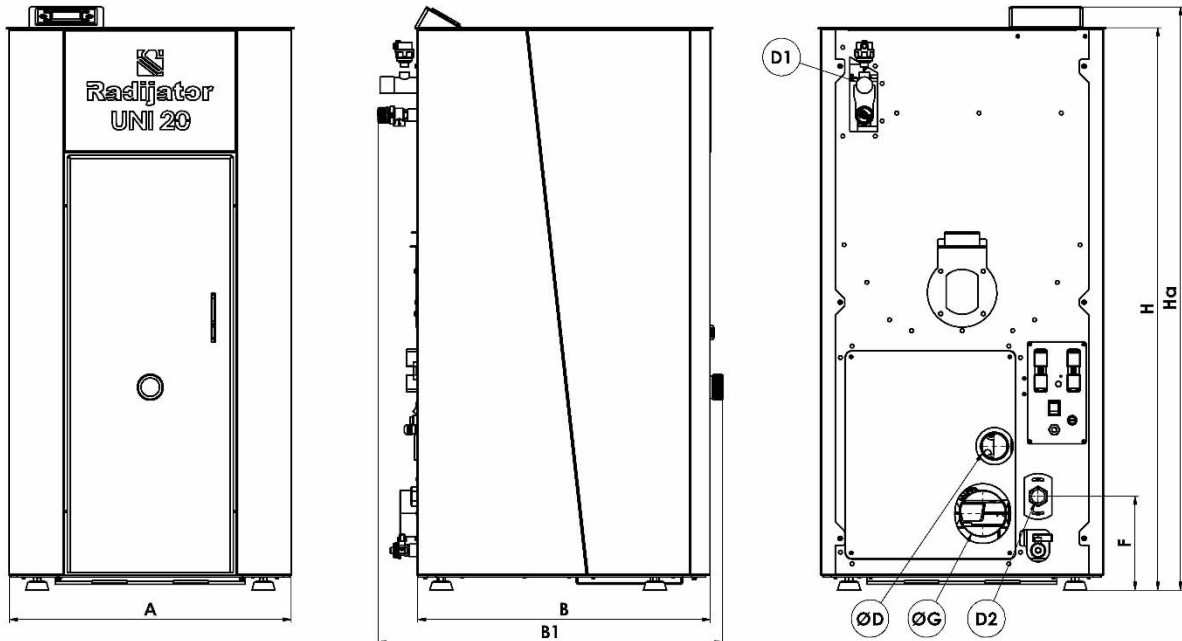

Tip kotla		UNI 20 / UNI 20 PLUS	
	Mere		
Nominalna toplotna snaga	kW	20	
Redukovana toplotna snaga		10,3	
Emisija CO pri nominalnoj toplotnoj snazi	mg/N	174,9	
Emisija CO pri redukovanoj toplotnoj snazi	m ³	165,9	
Zapremina vode u kotlu	L-cca	50	
Masa kotla	kg	220	
Potrebna promaja	Pa	10±2	
Max. radni pritisak	bar	2,5	
Probni pritisak		4,5	
Max. temperatura potisnog voda	°C	85	
Min. temperatura povratnog voda		60	
Stepen iskorišćenja	%	>93	
DIMENZIJE	A	mm	620
	B		630
	B1		740
	ØD		80
	E		1090
	F		205
	ØG		60,3 (2")
	H		1215
	Ha		1260
	D1		col
D2	1"		

NAPOMENA:

Priključak D1 – potisni vod
 Priključak D2 – povratni vod
 Priključak ØG – dovod vazduha za sagorevanje

*Temperatura dimnih gasova pri nominalnoj snazi za UNI 20 (165 - 175°C).

7. Hidraulička šema

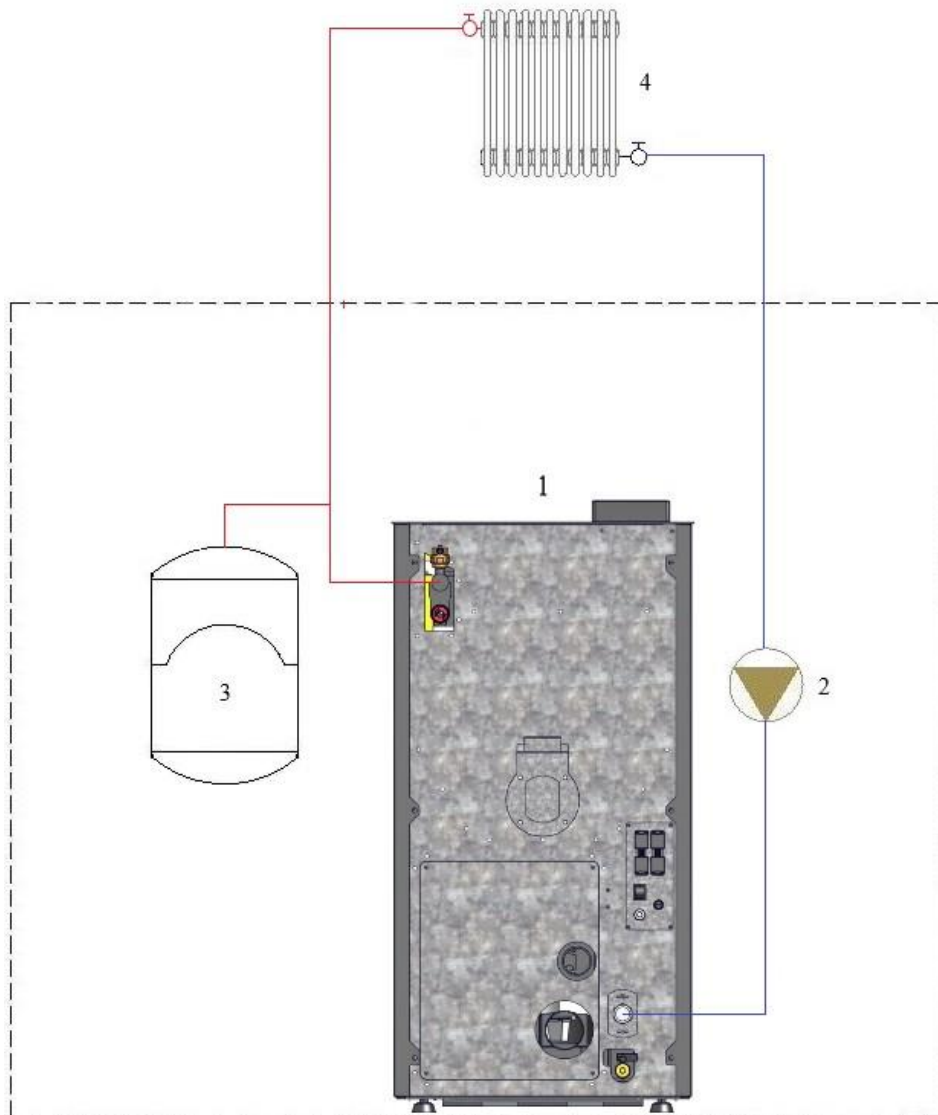

Slika 14. Šema povezivanja

1. PELET kotao;
2. Pumpa;
3. Ekspanzivna posuda;
4. Radijator (izmenjivač).

NAPOMENA: U sklopu PELET kotla UNI 20 PLUS ulazi i pumpa i ekspanzivna posuda od 10L.

⚠ Prilikom montaže na hidrauličku instalaciju kotao mora biti obezbeđen na propisan način od prekoračenja maksimalne radne temperature i pritiska.

- ⚠** *Za propisnu montažu odgovoran je instalater centralnog grejanja koji priključuje kotao na hidraulički sistem.*
- ⚠** *Radijator inženjering ,kao proizvođač kotla, ne preuzima nikakvu odgovornost za štete prouzrokovane lošim instaliranjem kotla.*
- ⚠** *Napomena: Prilikom punjenja hidrauličkog sistema obratiti pažnju na sigurnosne elemente prikazane na slici 15.*

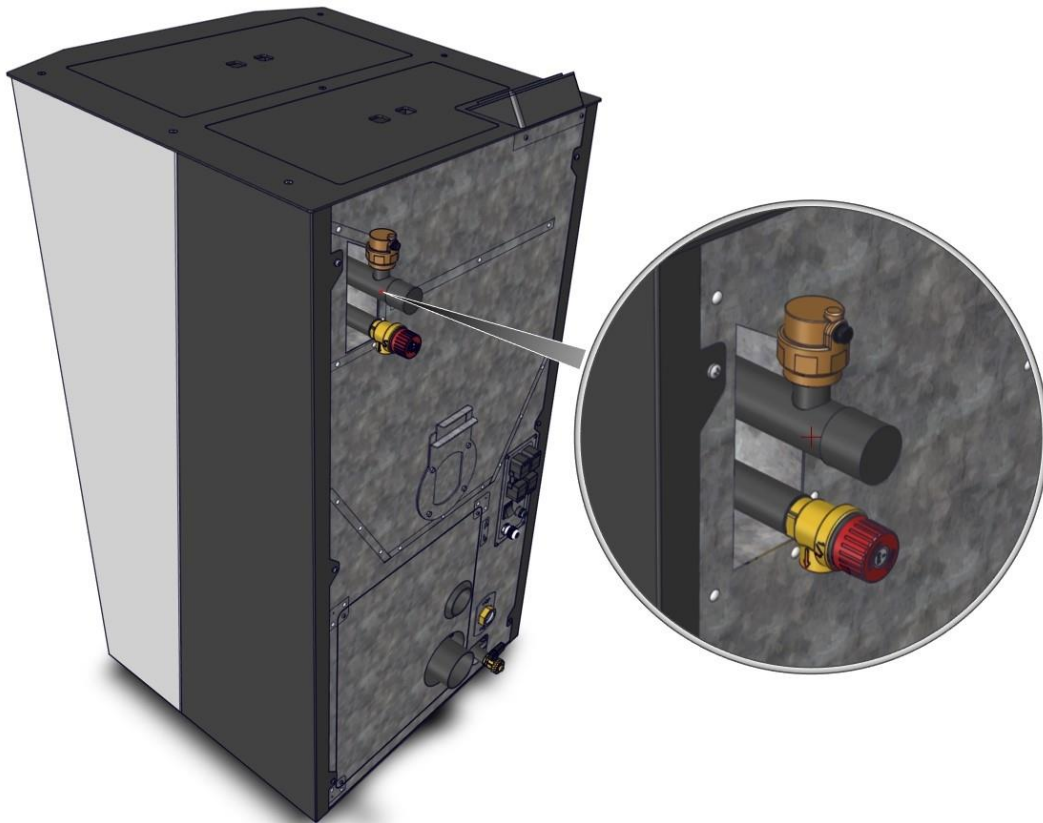

Slika 15. Prikaz odzračnog lončeta i sigurnosnog ventila na zadnjoj strani kotla

8. Start rada UNI 20 kotla i održavanje

⚠ Prvo puštanje kotla u rad obavlja tehničko lice koje ima sertifikat izdat od strane Radijator inženjeringa. Obavezna je obuka korisnika kotla.

Na taj način to lice je ovlašćeno da prijavi servisnoj službi u samoj fabrici vreme kada je kotao počeo da radi i u kakvom je stanju kotao bio prilikom prvog paljenja, dok kopiju izveštaja o puštanju kotla u rad zadržava. Garancija i upustvo za upotrebu se daje kupcu. Jedan primerak garancije se šalje proizvođaču. Ako garancija nije ispunjena, ona nije važeća.

Samo kotlovi koji su pušteni u rad od strane ovlašćenog tehničkog lica podležu uslovima kompletne garancije od dve godine.

Naredni tekst je namenjen samom korisniku kotla, kao jedna vrsta podsetnika, da ako ugasi kotao (npr. zbog čišćenja) bude u stanju da samostalno pokrene kotao.

⚠ Parametri vezani za rad kotla, a koji su dostupni korisniku su na samom displeju. Ostale parametre koji su u tzv. skrivenom meniju ne treba menjati bez saglasnosti tehničkog lica koje je pustilo kotao u rad ili same fabrike.

8.1. Displej automatike

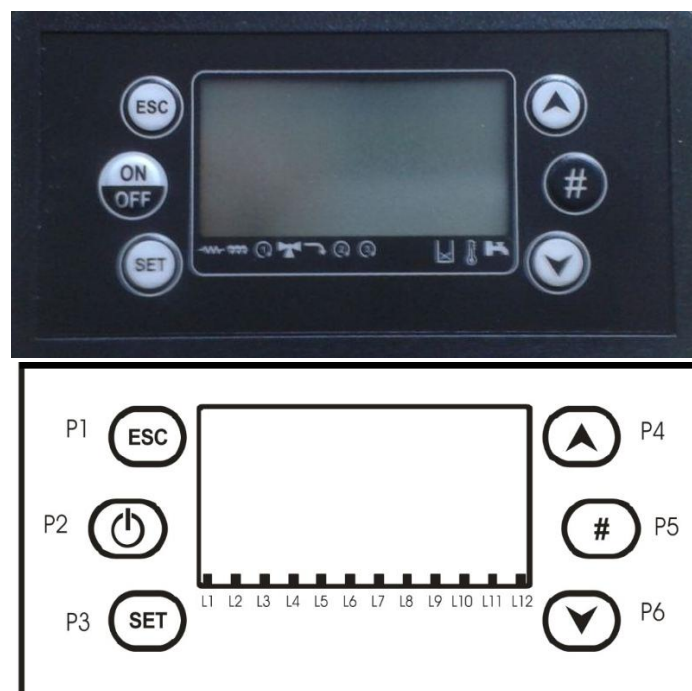

Slika 16. Slika i šematski prikaz displeja automatike

Tasteri:

Funkcije	Opis	Taster
Uključi/ Isključi	Funkcija paljenja, gašenja pritiskom na dugme 3 sekunde do zvučnog signala.	P2
Odblokirati	Funkcija odblokiranja, kada je sistem u blokadi pritiskom na dugme 3 sekunde do zvučnog signala uklanjate blokadu.	
Izmena vrednosti menija i podmenija	U sistemu izmene promeniti vrednosti u meniju ili podmeniju.	P4 P6
Ulazak u meni ili podmeni	U meniju startovanje podmenija i menija.	
Vizuelizacije	Ulazak i startovanje vizuelnog menija.	P1
Esc	Funkcija izlaska pritiskom na taster.	
Meni	Funkcija ulaska u meni ili podmeni.	P3
Izmena	Ulazak u sistem izmene u meniju.	
Potvrditi	Sačuvati podatke u meniju.	
Resetovanje sistema održavanja 2 funkcije	Resetovanje tajmera T67.	P5

Diode:

Funkcije	Opis	Svetleća dioda
Grejač	Dioda uključena: Grejač u funkciji.	L1
Dozator	Dioda uključena: Dozator u funkciji.	L2
Pumpa	Dioda uključena: Pumpa u funkciji.	L3
Mešni ventil	Dioda uključena: Mešni ventil u funkciji.	L4
Izlaz V2 konfigurisan kao sigurnosni ventil peleta ili motor za dopunu peleta ili motor za čišćenje	Dioda uključena: Izlaz V2 u funkciji.	L5
Ventilator za sagorevanje	Dioda uključena: Ventilator za sagorevanje u funkciji.	L6
Izlaz Aux2 konfigurisan kao sigurnosni ventil peleta ili motor za dopunu peleta ili motor za čišćenje	Dioda uključena: Izlaz Aux2 u funkciji.	L7
Nivo peleta	Dioda uključena: Nedostatak peleta.	L10
Spoljni termostat	Dioda uključena: Spoljni termostat u funkciji.	L11
Senzor protoka*	Dioda uključena: Zahtev za sanitarnu vodu.	L12

* Samo za vodovodne instalacije sa senzorom za merenje protoka

⚠ NAPOMENA: Dioda L4, L5, L10 i L12 nisu u funkciji kod UNI 20 kotla.

8.2. Kratko uputstvo za korisnika automatike

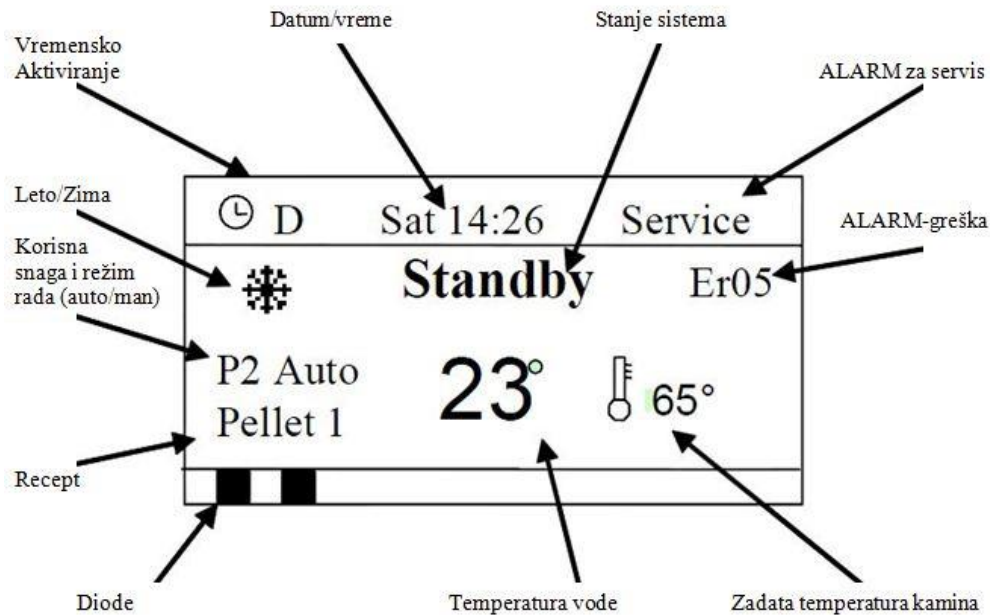

Slika 17. Prikaz LCD ekrana na displeju

- **Očitavanje trenutnog stanja kotla.**

Postupak:

Pritisnuti taster **P6** , nakon toga na ekranu se pojavljuju informacije (**Slika 18**).

Exhaust Temp	103	Izduvna temperatura [°C]
Boiler Temp	55	Temperatura vode u kotlu [°C]
Buffer Temp	55	Temperatura vode u akumulatoru* [°C]
Room Temp	35	Sobna temperatura* [°C]
Pressure	1548	Pritisak [mbar]
Air Flow	680	Protok vazduha [cm/s]
Auger	2.5	Vreme rada puža [s]
Product Code 395 – 0000		Kod proizvoda
FSYSD01000101.0.0		
FSYSF01000131.0.0		

Slika 18. Prikaz stanja kotla na displeju

⚠ NAPOMENA: Kod kotla **UNI 20** ne pojavljuju se informacije obeležene zvezdicom.

- **Ulazak u MENI automatike i objašnjenje funkcija.**

Postupak:







Pritisnuti taster **P3** , nakon toga na ekranu se pojavljuje padajuća lista (**Slika 19**).

Meni		Opis
Chombustion Power		Meni koji omogućava da izaberete podešenu snagu kamina.
Boiler Thermostat		Meni koji omogućava da promenite zadatu temperaturu kotla.
Chrono	Modality	Meni za izbor programa: Dnevni, Nedeljni, Vikend, Onemogućiti.
	Program	Meni koji dozvoljava podešavanja tri navedena programa: Dnevni, Nedeljni, Vikend.
Recipe		Meni za izbor recepta.
Time and Date		Meni za podešavanje vremena i datuma.
Remote Control		Meni za omogućavanje daljinskog upravljača SYTX.
Calibration		Meni za podešavanje radnog vremena dozatora i brzine ventilatora.
Load		Meni koji omogućava rad dozirnog sistema (prvo i ponovno punjenje prilikom početka rada kotla), ako je sistem u OFF režimu.
Summer-Winter		Meni za odabir zimskog ili letnjeg režima.
Language		Meni za odabir jezika na LCD panelu.
Keyboard Menu		Meni za podešavanje kontrasta i svetla na LCD panelu.
System Menu		Meni za ulaz u sistemski meni.

Slika 19. Prikaz i objašnjenje MENI automatike

- **Promeniti podešenu snagu kotla (Chombustion power).**

Postupak:

Pritisnuti taster **P3** , nakon toga na ekranu se pojavljuje padajuća lista, gde je i odmah markirana prva opcija **Chombustion Power**(**Slika 19**). Ponovo potvrditi tasterom **P3** , nakon toga pojavljuje se prikaz na displeju (**Slika 20**). Tasterima **P4** ili **P6**   zadajete podešenu snagu i na kraju ponovo potvrdite tasterom **P3** . Vratite se na osnovni prikaz displeja (**Slika 17**), pritiskom na taster **P1** .

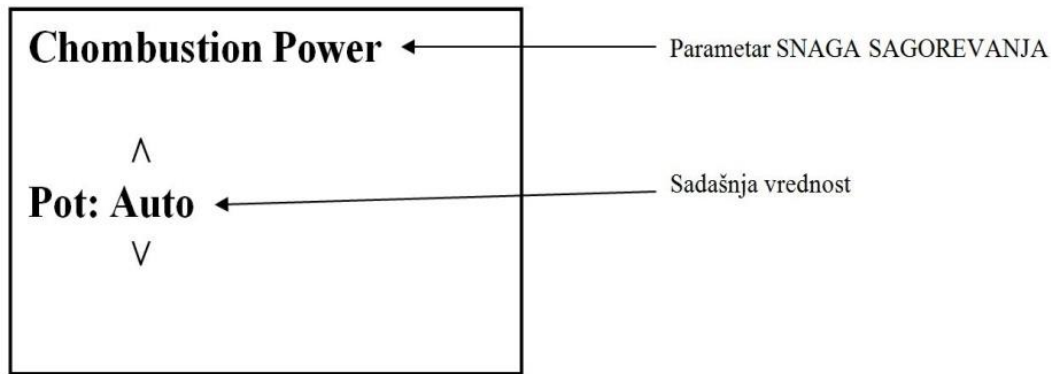









Slika 20. Prikaz i objašnjenje displeja u opciji Chombustion Power

⚠ **NAPOMENA:** Kod kotla *UNI 20* maksimalan broj podešenih snaga je 3.

- **Promeniti zadatu temperaturu vode u kotlu (Boiler thermostat).**

Postupak:

Pritisnuti taster **P3** , nakon toga na ekranu se pojavljuje padajuća lista, gde je i odmah markirana prva opcija **Chombustion Power**. Tasterima **P4** ili **P6**  , dolazite do opcije **Boiler Thermostat**. Ponovo potvrditi tasterom **P3** , zatim tasterima **P4** ili **P6**   zadajete temperaturu i na kraju ponovo potvrdite tasterom **P3** . Vratite se na osnovni prikaz displeja (Slika 17), pritiskom na taster **P1** .

- **Postaviti vremensko programiranje paljenja i gašenja kotla (Chrono).**
(ovu opciju koristite SAMO AKO STE PRETHODNO POSTAVILI TAČNO VREME I DATUM).











Što se vremenskog programiranja tiče, u samoj opciji postoje dve pod opcije, a to su: **Modality** i opcija **Program**.

Modality opcija služi za odabir načina programiranja, dakle da li ćete programiranje koristiti na dnevnom nivou, svaki dan posebno (**Daily**) (npr. Ponedeljak, Utorak, Sreda... Nedelja), na nedeljnom nivou (**Weekly**) (od Ponedeljka do Nedelje), i na vikend nivou (**Week-end**) (od Ponedeljka do Petka-posebno i od Subote do nedelje-posebno). Takođe, možete totalno isključiti opciju Chrono (**Disible**).

Program opcija služi za programiranje gore navedenih opcija **Daily**, **Weekly** i **Week-end**, odn. podešavanje tačnog vremena startovanja i prekida rada kotla.



Postupak:

Najpre, treba odlučiti kako želite programirati vreme puštanje i gašenja, da li će to biti dnevna, nedeljna ili vikend opcija. Ukoliko se odlučite za jednu od navedenih odabir ćete uraditi na sledeći način.

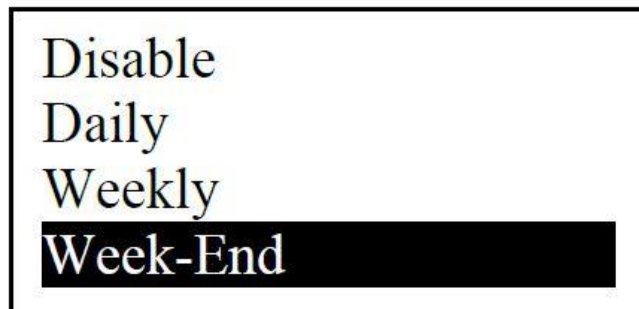



Pritisnuti taster **P3** , nakon toga na ekranu se pojavljuje padajuća lista, gde je i odmah markirana prva opcija **Chombustion Power**. Tasterima **P4 ili P6**  , dolazite do opcije **Chrono**. Ponovo potvrditi tasterom **P3**  (pojavljuju se dve opcije **Modality i Program**), zatim tasterima **P4 ili P6**   dolazite do željene opcije **Modality i potvrđujete je tasterom P3** . Nakon toga, u podmeniju nailazite na opcije **Daily, Weekly, Week-end i Disable (prikazano na slici 21)**. Tasterima **P4 ili P6**   odaberite jednu od njih i potvrdite tasterom **P3** .



Slika 21. Prikaz displeja nakon odabira opcije MODALITY

Kada ste izabrali način programiranja, automatski se vraćate na prikazu displeja **Modality i Program**. Tasterima **P4 ili P6**   prelazite na opciju **Program** i potvrđujete tasterom **P3** .

U ovoj opciji programirate tačno vreme paljenja i gašenja kotla koje ste prethodno odabrali u opciji **Modality**. Primeri programiranja prikazani su na (Slika 22, 23 i 24).

I dalje za prelazak koristite tastere **P4 ili P6**  , za potvrdu taster **P3** , za potvrdu odabrane vrednosti potvrditi tasterom **P5** , i za vraćanje korak unazad taster **P1** .

Daily	Monday	Monday
Weekly	Tuesday	ON OFF
Week-End	Wednesday	09:30 11:15 ✓
	Thursday	00:00 00:00
	Friday	00:00 00:00

Slika 22. Prikaz displeja nakon odabira opcije Daily

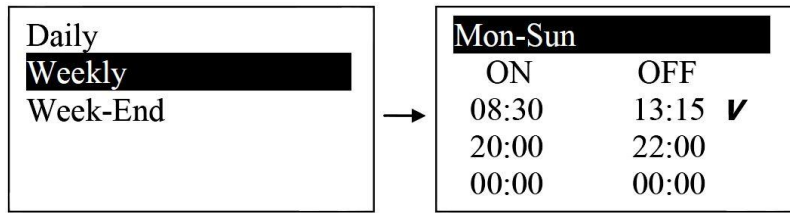

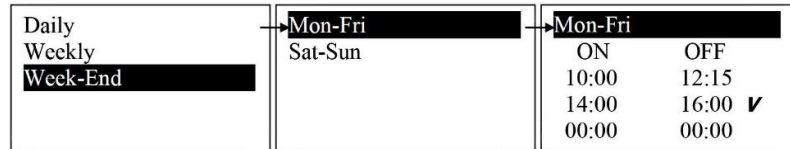

Slika 23. Prikaz displeja nakon odabira opcije Weekly







Slika 24. Prikaz displeja nakon odabira opcije Week-end

- **Promeniti recept (Recipe).**



Postupak:





Pritisnuti taster **P3** , nakon toga na ekranu se pojavljuje padajuća lista, gde je i odmah markirana prva opcija **Chombustion Power**. Tasterima **P4 ili P6**  , dolazite do opcije **Recept**.



Ponovo potvrditi tasterom **P3** , nakon toga pojavljuje se prikaz na displeju sa markiranim brojem koji je aktuelan recept. Tasterima **P4 ili P6**   zadajete podešeni recept (manji zadati broj recepta = manja vremena nalaganja dozera u radnim režimima, veći zadati broj recepta = veća vremena nalaganja dozera u radnim režimima) i na kraju ponovo potvrdite tasterom **P3** . Vratite se na osnovni prikaz displeja (**Slika 17**), pritiskom na taster **P1** .

- **Promeniti tačno vreme i datum (Time and Date).**

Postupak:



Pritisnuti taster **P3** , nakon toga na ekranu se pojavljuje padajuća lista, gde je i odmah markirana prva opcija **Chombustion Power**. Tasterima **P4 ili P6**  , dolazite do opcije **Time and Date**.





Ponovo potvrditi tasterom **P3**  pojavljuje se prikaz na displeju **podešavanje vremena i tačnog datuma** gde preko tastera **P4 ili P6**   prelazite sa opcije na opciju a preko tastera **P3**  potvrđujete komandu i menjate joj vrednosti opet preko tastera **P4 ili**

P6  . Kada se izabere željena vrednost potvrđuje se tasterom **P3** . Za izlazak i vraćanje korak unazad koristite taster **P1** .





- **Meni za podešavanje radnog vremena dozatora i brzine ventilatora (Calibration).**

Postupak:





Pritisnuti taster **P3** , nakon toga na ekranu se pojavljuje padajuća lista, gde je i odmah markirana prva opcija **Chombustion Power**. Tasterima **P4** ili **P6**  , dolazite do opcije **Calibration**.

Ponovo potvrditi tasterom **P3** , nakon toga, pojavljuje se prikaz na displeju za odabir kalibracije **Auger Calibration** ili **Fan Calibration**. Na displeju će biti markirana **Auger Calibration**, tasterima **P4** ili **P6**   izaberete šta želite da menjate i potvrdite tasterom **P3** .

Menjanje radnog vremena dozatora Auger Calibration

Ako ste izabrali **Auger Calibration** na displeju će biti markirana trenutna vrednost kalibracije (Set: 0, uglavnom je 0), tasterom **P4**  povećavate vrednost vremena doziranja, a tasterom **P6**  smanjujete radno vreme doziranja. Vrednosti su od -5 do 5, (manji zadati broj kalibracije = manja vremena nalaganja dozera u radnim režimima, veći zadati broj kalibracije = veća vremena nalaganja dozera u radnim režimima), kada izaberete brojnu vrednost doziranja ponovo potvrdite tasterom **P3** . Vratite se na osnovni prikaz displeja (**Slika 17**), pritiskom na taster **P1** .

Menjanje brzine ventilatora Fan Calibration

Ako ste izabrali **Fan Calibration** na displeju će biti markirana trenutna vrednost kalibracije (Set: 0, uglavnom je 0), tasterom **P4**  povećavate vrednost brzine ventilatora, a tasterom **P6**  smanjujete vrednost brzine ventilatora. Vrednosti su od -5 do 5, (manji zadati broj kalibracije = manja brzina ventilatora u radnim režimima, veći zadati broj kalibracije = veća brzina ventilatora u radnim režimima), kada izaberete brojnu vrednost brzine ventilatora potvrdite tasterom **P3** . Vratite se na osnovni prikaz displeja (**Slika 17**), pritiskom na taster **P1** .

8.3. Start rada *UNI 20* kotla

- **KORAK 1:** Kotao priključen na hidraulički sistem.
- **KORAK 2:** Sipati pelet u silos.
- **KORAK 3:** Proveriti da li su svi poklopci dobro zatvoreni i da li su vrata kotla pravilno zatvorena.
- **KORAK 4:** Uključiti kotao, prekidač se nalazi sa zadnje strane kotla.

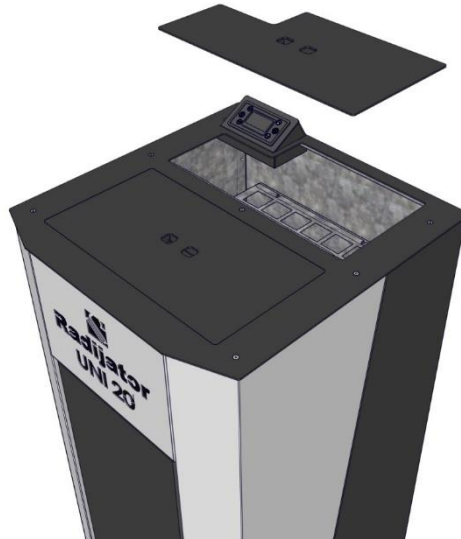



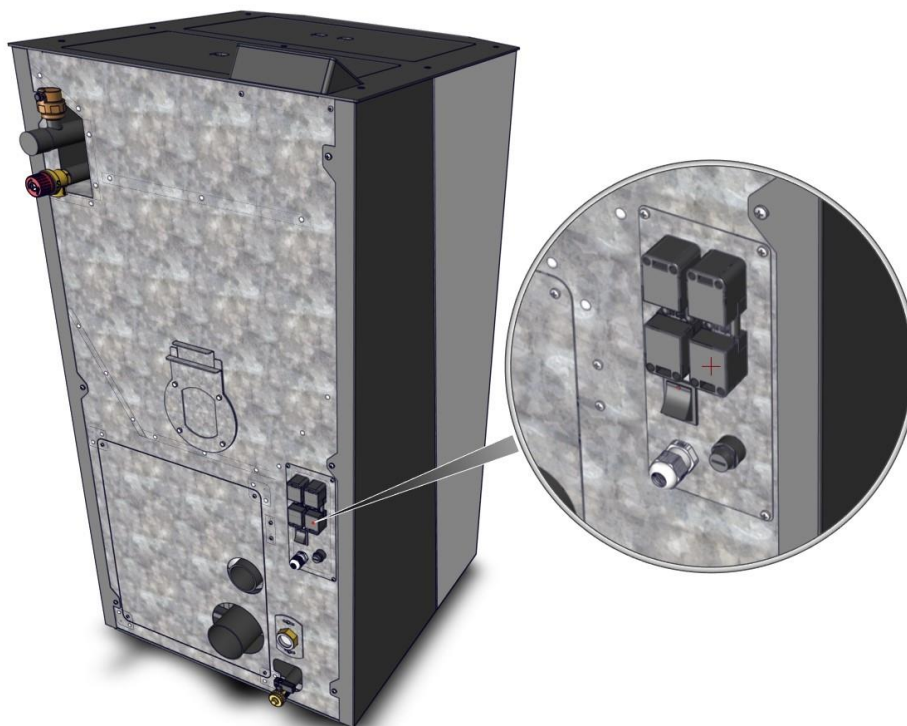







Slika 25. Prikaz otvora za sipanje peleta



Slika 26. Prikaz pozicije kablovske uvodnice, glavnog prekidača kao i sigurnosnog termostata

KORAK 5: Pri prvom pujanju kotla u rad ili ako je nestalo peleta u silosu tokom rada kotla, potrebno je pokrenuti dozirni sistem, kako bi prva zrna peleta upala u šolju za sagorevanje. (*Ovaj postupak može se primeniti samo dok je automatika u OFF režimu (slika 17 stanje sistema)*)

Postupak:

Pritisnuti taster **P3** , zatim tasterima **P4 ili P6**   u podmeniju dolazite do funkcije **LOAD**, potvrdite tasterom **P3** , tasterom **P4 ili P6**   preći sa **OFF** na **ON**, potvrditi sa tasterom **P3** . Potvrdom na taster pokreće se dozer, sve dok prva zrna peleta ne počnu da upadaju u šolju za sagorevanje. Nakon toga, takođe tasterom **P4 ili P6**   prelazite sa **ON** na **OFF**, potvrditi sa tasterom **P3** . Dozator tada staje sa radom. Tasterom **P1**  izađite iz podmenija.

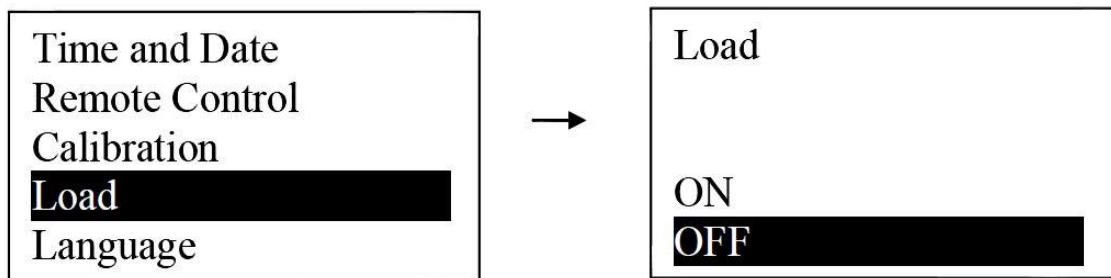

Slika 27. Prikaz displeja prilikom odabira funkcije LOAD

➤ **KORAK 6:** Startovati kotao.

Postupak:

Pritisnite taster **P2** , zadržite 2-3 sekunde do zvučnog signala. Tada na displeju piše „**Check Up**”, to će trajati 30 sekundi. Prilikom provere stanja kotla, ako su ispunjeni svi uslovi za rad kotla (pelet je prema standardima, odgovarajući dimnjak, zatvorena vrata kotla, čisti dimni kanali i šolja za sagorevanje, dobro zatvoreni poklopci za čišćenje izmenjivača), nastavlja se proces potpale, tada će na displeju pisati „**Ignition**”. Kotao je krenuo u rad. Proces sagorevanje počinje za 5 do 10min.

Prilikom prve potpale treba očekivati nešto pojačanu pojavu dima i oštrih mirisa sve dok fabrički premazi protiv korozije ne završe sa finalnim sušenjem odn. dogorevanjem.

Isti postupak koristimo za gašenje kotla, dakle dužim pritiskom tastera **P2**  do zvučnog signala prelazimo u gašenje kotla.

- Na automatiku može biti povezan sobni termostat. U ovom slučaju, važno je podesiti temperaturu prostorije koja je glavni parametar za rad kotla i temperaturu vode u kotlu (70°C). Kada je aktiviran rad sobnog termostata, kotao najpre ima zahtev za postizanjem temperature sobe, stim da je ograničen zadatom temperaturom vode u njemu. Postoji mogućnost da kotao prestane sa radom pre zadate temperature sobnog termostata, u ovom slučaju treba podići zadatu temperaturu vode u kotlu npr.70°C.

Upozorenje: Obavezno izvršiti analizu dimnih gasova nakon završetka instalacije kotla. Izmeriti procenat kiseonika (O₂).

8.4. Greške prilikom startovanja i u toku rada *UNI 20* kotla.

Sve moguće greške u početnoj fazi rada tj. prilikom potpale mogu pa i u samom radu automatika prijavljuje na displeju. (**Slika 17**-ALARM greška).

Oznake grešaka i objašnjenja prikazane su u sledećoj tabeli.

Er01	Greška - Visok napon 1. Sigurnosni termostat aktiviran
Er02	Greška - Visok napon 2. Sigurnosni presostat vazduha aktiviran
Er03	Greška - Gašenje kada je temperature dimovodnih gasova ispod predviđene.
Er04	Greška - Gašenje kada je temperature vode iznad zadate.
Er05	Greška - Gašenje kada je temperature dimovodnih gasova preko predviđene.
Er07	Greška - Enkodera.Ova greška se javlja zbog nedostatka signala enkodera
Er08	Greška - Enkodera. Ova greška je vezana za lose učitavanje enkodera
Er09	Greška - Slab pritisak vode
Er10	Greška - Visok pritisak vode
Er11	Greška - Sat realnog vremena, sistemska greška
Er12	Greška - Gašenjene zbog neuspele potpale
Er15	Greška - Nedostatak napona
Er17	Greška - na regulatoru senzora protoka vazduha
Er18	Greška - Nedostatak peleta
Er39	Greška - Pokvaren senzor regulatora protoka vazduha
Er41	Greška - Nije postignut minimalni protok vazduha
Er42	Greška - Maksimalni protok vazduha iznad predviđenog.

Svi mogući problemi i zastoji u radu ovog uređaja mogu se podeliti u dve velike grupe.

- **Grupa I.** Zastoj u radu prilikom potpale ili ponovnog kretanja u rad u toku dana.
- **Grupa II.** Zastoj koji se javlja kad je kotao već bio u radnom procesu, na displeju je postojalo obaveštenje (Run Mode), ali posle dostizanja zadate temperature i mirovanja gubi kontinuitet sagorevanja.

Grupa I

Najčešće signalizacije na displeju vezane za ovu grupu grešaka su **Er02, Er12, Er41**.

Prilikom prve potpale po ugradnji kotla na hidro instalaciju treba slediti uputstva iz odeljka "Start rada kotla".

Naročito obratiti pažnju na dimovod (prečnik, broj lukova, dihtovanje, ...), kao i na dimnjak (prečnik, visina, izolovanost, dihtovanje revizionih otvora, zaprljanost dimnjaka, itd.).

Greška Er02

Prilikom uključivanja kotla, u fazi provere sisteme kotla „**Check Up**”, ako nisu ispunjeni uslovi za rad, na displeju se javlja greška **Er02** (Visok napon 2. Sigurnosni presostat vazduha aktiviran), kotao ide u fazu gašenja (Extingushing). U ovom slučaju treba proveriti sledeće uzroke:

Moguć uzrok 1.

- **PROBLEM 1.** Nisu dobro zabravljena vrata kotla ili nije dobro dihtovanje na nekom od revizionih otvora za čišćenje kotla.
- Postupak za rešavanje **PROBLEMA 1.** Proveriti dihtovanje na nekom od revizionih otvora za čišćenje kotla, proveriti da li su pravilno zabravljena vrata kotla, posle zatvaranja vrata kotla, sačekati 30-ak sekundi pre ponovnog startovanja kotla.

Moguć uzrok 2.

- **PROBLEM 2.** U toku rada kotla otvarana su vrata kotla.
- Postupak za rešavanje **PROBLEMA 2.** Ne otvarati vrata kotla prilikom rada, smeju se otvarati samo kada kotao ne radi.(OFF)

Greška Er41

Prilikom uključivanja kotla, u fazi provere sisteme kotla „**Check Up**”, ako nisu ispunjeni uslovi za rad, na displeju se javlja greška **Er41** (Nije postignut minimalni protok vazduha), kotao ide u fazu gašenja (Extingushing). U ovom slučaju treba proveriti sledeće uzroke:

Moguć uzrok 1.

- **PROBLEM 1.** U silosu nema peleta.
- Postupak za rešavanje **PROBLEMA 1.** Sipati pelet u silos.

Moguć uzrok 2.

- **PROBLEM 2.** Nisu dobro zabravljena vrata kotla ili nije dobro dihtovanje na nekom od revizionih otvora za čišćenje kotla.

Postupak za rešavanje **PROBLEMA 2.** Proveriti dihtovanje na nekom od revizionih otvora za čišćenje kotla, proveriti da li su pravilno zabravljena vrata kotla, posle zatvaranja vrata kotla, sačekati 30-ak sekundi pre ponovnog startovanja kotla.

Moguć uzrok 3.

- **PROBLEM 3.** U šolji za sagorevanje se nakupilo previše naslaga ili je ostalo nesagorelog peleta, tokom prethodnog rada kotla.
- Postupak za rešavanje **PROBLEMA 3.** Očistiti šolju za sagorevanje peleta.

Moguć uzrok 4.

- **PROBLEM 4.** U dimovodnim kanalima se nakupilo previše naslaga, tokom prethodnog rada kotla.
- Postupak za rešavanje **PROBLEMA 4.** Očistiti dimovodne kanale kotla.

Moguć uzrok 5.

- **PROBLEM 5.** Zaprljan dimnjak, nakupilo se previše naslaga.
- Postupak za rešavanje **PROBLEMA 2.** Očistiti dimnjak.

Greška Er12

Ako posle prvog pokušaja paljenja nema značajne pojave plamena i ozbiljnijeg porasta temperature dimnih gasova, na displeju se javlja greška **Er12** (neuspela potpala), i kotao ide u fazu gašenja (Extingushing). U ovom slučaju treba proveriti sledeće uzroke:

Moguć uzrok 1.

- **PROBLEM 1.** Loš kvalitet peleta. Pelet male snage, povećane vlažnosti.
- Postupak za rešavanje **PROBLEMA 1.** Uzeti pelet proverenog kvaliteta i probati.

Moguć uzrok 2.

- **PROBLEM 2.** Temperatura vazduha (koji je doveden kotlu za sagorevanje i potpalu) je izuzetno niska (ispod nule).
- Postupak za rešavanje **PROBLEMA 2.** Podizanje vremena predgrevanja grejača za potpalu, t02, za 10 sekundi.

Moguć uzrok 3.

- **PROBLEM 3.** Mrežni napon na koji je priključen kotao je znatno manji od 220-230V, tako da je i snaga grejača manja.
- Postupak za rešavanje **PROBLEMA 3.** Podizanje vremena predgrevanja grejača za potpalu, t02, za 10 sekundi. Ako ova mera ne daje rezultate onda priključiti mrežni ispravljač napona.

Moguć uzrok 4.

- **PROBLEM 4.** Količina peleta u komori za sagorevanje je nedovoljna za kretanje kotla u rad.
- Postupak za rešavanje **PROBLEMA 4.** Povećati početno doziranje peleta t03 za 5 do 10 sek, ako opet ima nedovoljno peleta, mogući su mehanički problemi sa pelet transporterom. Proveriti ispravnost dozatora.

Moguć uzrok 5.

- **PROBLEM 5.** Posle faze fiksnog nalaganja (t03), u fazama t04 i t05 dođe do uspostavljanja plamena, ali za vreme trajanja potpale (Ignition), nije moguće preći u stabilizaciju (Stabilization), pa plamen postaje sve slabiji tako da dođe do pada temperature dimnih gasova i gašenja (Extinguishing). Do ovog problema dolazi zbog različitog kvaliteta peleta.
- Postupak za rešavanje **PROBLEMA 5.** Povećati vreme fiksnog nalaganja peleta t03 (za 5 do 10 sekundi), i po potrebi vreme nalaganja peleta u drugoj fazi potpale C10. Preporuka da se ovo vreme produžava oprezno, prvo za 0,1 ili 0,2 sekunde.

Moguć uzrok 6.

- **PROBLEM 6.** Postoje situacije u kojima kotao pređe fazu potpale (Ignition), ali se u fazi stabilizacije jasno vidi da nema dovoljno peleta. Proverom dimnih gasova kotao iz faze stabilizacije (Stabilization) neće da pređe u radni režim (Run mode). Do ovog problema dolazi zbog različitog kvaliteta peleta.
- Postupak za rešavanje **PROBLEMA 6.** Ovaj problem se otklanja produžavanjem vremena nalaganja u fazi stabilizacije C02. Preporuka da se ovo vreme produžava oprezno, prvo za 0,1 ili 0,2 sekunde, pa ako i to nije dovoljno onda za još 0,1 itd. Posle toga rešavanje problema kombinovati sa postupkom iz sledeće tačke.

Moguć uzrok 7.

- **PROBLEM 7.** Kotao je povezan sa sobnim termostatom. Povećanjem zadate temperature na sobnom termostatu ne dolazi do kretanja kotla u fazu potpale (Ignition) i ne dolazi do aktiviranja grejača za potpalu.
- Postupak za rešavanje **PROBLEMA 7.** Proveriti da li je temperatura u sobi zaista manja od zadate. Takođe proveriti vremensko programiranje sobnog termostata i na kraju proveriti ispravnost sobnog termostata.

Grupa II

Najčešće signalizacije na displeju vezana za ovu vrstu grešaka su **Er03, Er05**.

Greška Er03

Moguć uzrok 1.

- **PROBLEM 1.** Kotao je bio u radnom režimu (Run mode), ali je došlo do pada dimnih gasova tokom rada, kotao ide u fazu gašenja (Extingushing).
- Postupak za rešavanje **PROBLEMA 1.** U ovakvim slučajevima treba proveriti da li ima peleta u silosu, ili je nesto upalo u dozator peleta, pa nije mogao da ubacuje pelet u šolju za sagorevanje.

Moguć uzrok 2.

- **PROBLEM 2.** Kotao je u radnom režimu (Run mode), ali vremenom dolazi do sve većeg nagomilavanja šljake i pepela po dnu šolje za sagorevanje. Vremenom nesagoreli pelet popunjava šolju za sagorevanje i dolazi do smanjenja plamena i odlaska kotla u gašenje (Extingushing).
- Postupak za rešavanje **PROBLEMA 2.** Najbolje je povećati snage ventilatora u svim režimima i to preko funkcije kalibracije (Calibration- Fan Calibration) ili smanjivanja doziranja peleta i to preko funkcije kalibracije (Calibration- Auger Calibration). Ako i to nije pomoglo za manje nagomilavanje šljake i pepela po dnu šolje za sagorevanje, izaberite drugi recept za sagorevanje (brojno manju vrednost od trenutne) i to preko funkcije Recipe. (Postupak je objašnjen u odeljku - **8.2. Kratko uputstvo za korisnika automatike**)

Greška Er05

Moguć uzrok 1,

- **PROBLEM 1.** Kotao radi, ali u toku rada dolazi do zastoja i signalizacije na displeju Modulation, a zatim i sigurnosnog gašenja (Extingishing). Na kraju displej signalizira grešku **Er05**.
- Postupak za rešavanje **PROBLEMA 1.** Do ovoga dolazi jer su dimni gasovi prevelikih temperatura. Najčešći razlozi su zaprljanost kotla, prejak dimnjak, preveliko nalaganje peleta zbog karakteristike peleta, itd.

8.5. Održavanje i čišćenje *UNI 20* kotla

Kotao *UNI 20* zahteva svakodnevno i periodično čišćenje.

Svakodnevno čišćenje se odnosi na prostor samog ložišta, odnosno šolje za sagorevanje, gde stalnim izbacivanjem pepela omogućavamo bolji rad elektro grejača za potpalu i bolje sagorevanje tj. veću količinu vazduha kroz otvore na šolji. Pepee već u toku dana počinje da se taloži na podu, prostoru oko samog ložišta.

Takođe potrebno je svakodnevno očistiti cevi izmenjivača, korišćenjem ručice bravice vrata, kojom ćemo jednostavnim pomeranjem poluge napred-nazad pokretati mehanizam koji će pomerati turbulatore i čistiti cevi izmenjivača (**Slika 28**).

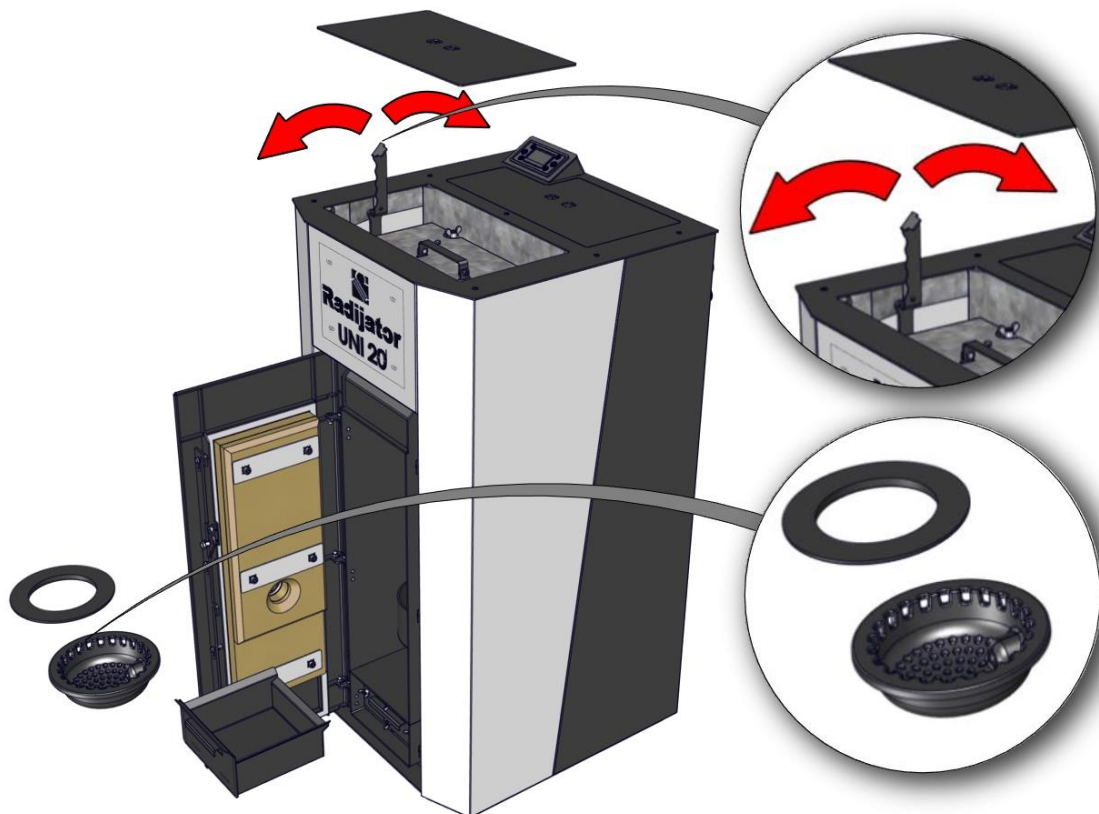

Slika 28. Čišćenje solje za sagorevanje i turbulatora

Na svaka 3 do 4 dana potrebno je isprazniti pepeljaru ložišta.

Jednom u dve nedelje potrebno je očistiti naslage na zidovima samog ložišta. Ovim dobijamo bolji stepen prenosa jer jedan milimetar naslaga katrana i čađi smanjuje provodnost za 5%.

Otvoriti gornji poklopac za čišćenje, i očistiti sva dostupna mesta iznad turbulatora.

Takođe treba otvoriti prednji revizionni poklopac dimovodnih kanala i očistiti ceo prostor dimovodnih kanala i kutije ventilatora od naslaga čađi i pepela (**Slika 29**).

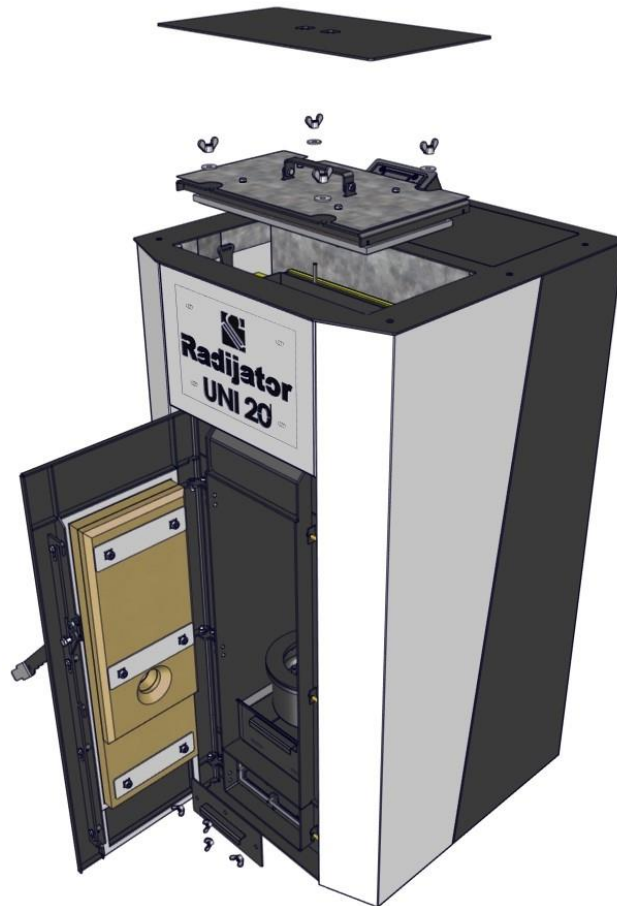

Slika 29. Prikaz elemenata koji se rasklapaju prilikom čišćenja

Ukoliko se u kotlu, tokom korišćenja javi kondenzacija, potrebno je pokupiti kondenz, a ceo kotao iznutra premazati baznim sredstvima za čišćenje ili barem vodenim rastvorom građevinskog kreča. Na taj način se vrši neutralizacija kiselina usled kondenzacije.

- ⚠ Pri održavanju i servisiranju kotla, obavezno isključiti kotao sa napajanja.**
- ⚠ Obavezno konzervirati kotao na kraju grejne sezone. U toj situaciji zatvoriti i sve otvore na kotlu da ne dođe do cirkulacije vazduha kroz kotao jer i tako može doći do pojave vlage u kotlu.**
- ⚠ Obavezno dobro priviti navrtke na poklopcima za čišćenje jer kotao neće moći da krene u rad (izbacivaće greške Er02 ili Er41).**
- ⚠ Održavanje kotla je jedan od najbitnih faktora za dužinu radnog veka kotla. Naročito je bitno da u periodu između dve sezone kotao bude očišćen i da se izvrši neutralizacija kiselina na već opisan način.**

8.6. Natpisna pločica

Natpisna pločica je nalepljena na dobro vidljivo mesto na kotlu i sadrži sledeće (videti sliku u tački NALEPNICE):

1. Tehnički podaci sa nalepnice:

- Proizvođač (Radijator inženjering)
- Serijski broj kotla (primer: N°:170616003)
- Godina proizvodnje (primer: 2020)
- Tip kotla (*UNI 20*)
- Stepen korisnosti (Nominalna - 93%, Redukovana - 94%)
- Radni pritisak (2,5bar)
- Električni napon (230V)
- Frekvencija (50Hz)
- Nominalna el. snaga (500W)
- Gorivo (Pelet - C1)

	<i>UNI 20 / UNI 20 PLUS</i>
Nominalna toplotna snaga	20 kW
Redukovana toplotna snaga	10.3 kW

2. Nalepnica uvoznika

3. OEEO

4. Ostale oznake na kotlu



9. Garancija

1. Radijator inženjering pokriva različite garancijske periode za različite delove (što je navedeno u daljem tekstu) samo ako su ispunjeni sledeći uslovi garancije:

- Kotao mora biti priključen po navedenim hidrauličkim šemama iz tehničkog uputstva, naročito obratiti pažnju na montažu kotla na dimnjak i njegovo pozicioniranje. **(videti tačku 3.)**
- Kotao mora biti priključen na dimnjak propisanog poprečnog preseka, karakteristika izolacije i visine. **(videti tačku 3.4)**
- Dimovod od kotla do dimnjaka mora biti izveden po tehničkom uputstvu.
- Kod kotla moraju biti izvršena i navedena elektro priključenja iz tehničkog uputstva, naročito se misli na karakteristike sobnog termostata, karakteristike mrežnog napona koji mora biti u određenim granicama.
- Korisnik mora da se pridržava navedenih uputstava o korišćenju i održavanju. **(videti tačku 8.)**

2. Garancijska izjava

Izjavljujemo:

- da proizvod ima propisana i deklarirana kvalitetna svojstva.
Obavezujemo se, da ćemo na zahtev kupca ako pravovremeno u garancijskom roku podnese zahtev za popravku, o svakom trošku izvršiti sve popravke kvarova, tako da će proizvod raditi u skladu sa deklariranim svojstvima,
- da će proizvod u garancijskom roku raditi besprekorno ako se budu poštovala uputstva za upotrebu, rad i montažu,
- da ćemo u garancijskom roku biti spremni da otklonimo sve kvarove na proizvodu i držati na zalihama sve potrebne rezervne delove,
- **garancijski rok počinje od DANA KUPOVINE I TRAJE 60 MESECI ILI 72 MESECA OD DATUMA PROIZVODNJE (datum proizvodnje nalazi se na nalepnici sa zadnje strane kotla),**
- **GARANCIJA OD 60 MESECI VAŽI SAMO AKO SE KOTAO REDOVNO SERVISIRA OD STRANE CENTRALNOG SERVISA RADIJATOR INŽINJERINGA u periodu naznačenom za isti (dalje u tekstu),**
- **garancija važi ako je garantni list overen od strane prodavca i ako je upisan datum kupovine i priložen račun. TAKOĐE BITNO JE IMATI I NALOG ZA PUŠTANJE U RAD. (overen od strane ovlašćenog servisa)**

3. Garancijski period od jedne godine važi za sledeće delove:

- za ležajeve,
- elektro grejač za potpalu.

4. Garancijski period od dve godine važi za sledeće delove:

- ventilator,
- displej, automatiku kotla sa sigurnosnim termostatom i ostalim elektro delovima (presostat vazduha),
- sondu dimovodnih gasova,
- sondu temperature kotlovske vode,
- motor reduktor,
- pužne spirale,
- šolja za sagorevanje,
- elektro konektore,
- izolacijske materijale na vratima i otvorima za čišćenje,
- turbulatore i mehanizam za čišćenje,
- ekspanziona posuda, ventil sigurnosti, odzračni ventil i ležaj (klizni ležaj).

5. Garancijski rok ne važi:

- ukoliko se posle svake grejne sezone ne odradi redovan servis,
- za zamenu delova kod redovnog godišnjeg održavanja u skladu sa uputstvima,
- kod kvarova koje je načinio kupac zbog nestručnog rukovanja proizvodom,
- kod mehaničkih kvarova načinjenih prilikom transporta i prilikom korišćenja (čvrsti predmeti),
- ako je proizvod instaliran nestručno, suprotno važećim propisima iz tog područja,
- ako je kupac koristio proizvod iznad deklariranih svojstava i u normalnim okolnostima,
- na staklo na vratima kotla;
- na ručicu za vrata kotla.

6. Garancijski rok prestaje da važi:

- ako se ustanovi da je kvarove otklanjala neovlašćena osoba ili neovlašćeni servis,
- ako kod popravke nisu bili upotrebljeni i ugrađeni originalni delovi,
- kad ističe garancijski rok.

7. Kod prijave kvarova obavezno je dati sledeće podatke:

- naziv i tip proizvoda,
- datum kupovine,
- fabrički ili radionički broj kotla,

- kratak opis kvara, odnosno nedostatka,
- tačnu adresu i kontakt telefon, mejl.

8. Redovan godišnji servis

Redovan servis se odrađuje na kraju svake grejne sezone u periodu od 15.4. do 31.8. i naplaćuje se utvrđenim cenovnikom firme “Radijator Inženjering”. Servisni postupak tehničkih lica koja obavljaju redovne godišnje servise, a koja su od strane proizvođača ovlašćena za to, obuhvataju sledeće operacije:

⚠ NAPOMENA: Serviser je dužan da pregleda sve navedene delove (sa liste) dozatora i izmenjivača, i ukoliko dođe do zamene bilo kojih delova na iste korisnik dobija gore navedenu garanciju kao i garanciju na još 12 meseci na telo kotla (izmenjivač). Garancija se može produžiti do 5 god. od datuma puštanja u rad. Servis i produženje servisa može da obavlja lice koje šalje centralni servis “Radijator inženjering”-a. Na nezamenjene delove posle odrađenog servisa garancija ne važi.

- Demontaža pelet transportera, provera ispravnosti istog i provera ispravnosti ležaja i podmazivanje;
- Ležaj ne sme da ima otežano okretanje. U suprotnom ležaj se menja. Ukoliko se utvrdi da je do oštećenja ležaja došlo zbog upadanja čvrstog predmeta u pelet transporter (zbog greške korisnika ili proizvođača peleta), Radijator inženjering naplaćuje vrednost ležaja.
- Demontaža šolje za sagorevanje od ložišta i čišćenje prostora ložišta ispod šolje. Provera stanja šolje;
- Izvaditi sondu dimnih gasova i očistiti je od naslaga;
- Provera ventilatora;
- Provera dihtovanja vrata;
- Provera održavanja kotlovske izmenjivača.
- Čišćenje dimovodnih kanala.

Contents:

1. Important warnings	41
1.1. The minimal distance from flammable materials	42
2. The description of the UNI 20 boiler	43
3. Installing	44
3.1 General warnings	44
3.2. Safety measures and safety devices of the UNI 20 water boiler	45
3.3. The operating space and position of the UNI 20 water boiler.....	48
3.4. Installing the <i>UNI 20</i> boiler to the chimney	49
4. The cross-section of the <i>UNI 20</i> water boiler with the description of elemets	53
5. The diagram on how to connect automatic controls	54
6. Technical information table	55
7. The hydraulic diagram	56
8. Starting the <i>UNI 20</i> water boiler and maintenance	58
8.1. Automatic controls display	59
8.2. Brief instruction for the automatic controls user	61
8.3. Starting the <i>UNI 20</i> boiler	67
8.4. Start-up and working errors of the <i>UNI 20</i> kotla.....	69
8.5. Maintenance and cleaning the <i>UNI 20</i> kotla	74
8.6. Nameplate.....	76
9. Warranty.....	77

1. Important warnings

General warnings

- Upon removing the package, make sure that the delivery is complete and, in case you are missing something, refer to the seller who sold you the boiler.
- The boiler must be used exclusively for the use intended by the seller. Every kind of responsibility won't be taken by the manufacturer for the damage caused to people, animals, or things in case of installation errors, regulation, maintenance, or improper use.
- In case of leakage, remove the device from the power supply unit, stop the water supply, and inform the licensed service department or the licensed fitter.
- This manual is an integral part of the device and has to be kept with care and has to come with the device in case of changing owner or user, or in case of being connected to another installation. In case of being damaged or lost, request a new copy from the licensed seller.

Boiler is a heat generator comprised of the mechanical part in which water is subjected to pressure, but there are many electrical components subjected to voltage. In these devices where the probability of contact between water and electrical components is high, the following general and special safety measures have to be followed:

- Children and persons with certain limitations without supervision mustn't use the boiler.
- Water boiler mustn't be used on installations with operating pressure higher than 2.5 bars and operating temperature higher than 90°C.
- This device is a thermal energy producer through water as well as directly, by emitting into the surrounding space. Therefore, there are surfaces so heated that touching them can cause serious injuries. While working with those surfaces, use protective equipment. Especially, pay attention to keep children away from directly coming into contact with the device.
- Every sort of intervention by a technician or cleaning by the user is forbidden until the device is removed from the mains power supply by removing the outlet from the wall.
- The replacement of safety components is forbidden. Replace these components in case of malfunction only with the consent of a licensed technician from the manufacturer, that is Radiator inženjering, or contact the manufacturer directly.
- The exposure of water boiler to natural disasters is forbidden. This device isn't designed to be installed externally (outside).
- Shutting down the device is forbidden if the outdoor temperature may drop below zero degrees Celsius (freezing hazard).
- Putting fingers and other items into the holes located on the outer parts of the device's plating. Under the plate, there are electrical components and conductors subjected to voltage as well as mechanically operated devices (the electric gear motor and the fan). Coming into contact with them can lead to electrocution and physical injuries.
- It is forbidden to install the device in the proximity of flammable materials, especially pay attention to the material which isolates the boiler from the floor. It has to be inflammable and possess specific dimensions. Refer to the section 'Installing'.
- The water boiler mustn't be covered, nor can it have any objects on or around it.

1.1. The minimal distance from flammable materials

- Ensure the appropriate distance from flammable materials, if necessary provide protection for them.
- The minimal distance from flammable materials is regulated by law – please seek information from the professionals whose profession is heating and chimneys.
- The minimal distance between the boiler and flue gas discharge pipes from the materials of low and average flammability should be at least 100mm.
- The minimal distance from the easily flammable materials is 200mm and the same applies to the materials of an unknown flammability rate.



Fire hazard!

- Storing flammable materials and liquids close to the boiler is forbidden.
- It is mandatory to inform users of the necessary minimal distance between flammable materials and the boiler.

Combustibility of Construction materials	
A ... inflammable	asbestos, stone, building stone, ceramic wall tiles, terracotta, stucco, glazed concrete (without organic additives)
B ... Not easily flammable	drywall, glass fibers, and isolation panels (AKUMIN, IZOMIN, RAJOLIT, LIGNOS, VELOKS, HERAKLIT)
C1 ... Slow burn rate	beech and oak wood, composite wood, felt, and isolation panels (HOBREKS, VERZALIT, UMAKARTA)
C2 ... Average burn rate	pine wood, larch wood, and fir wood, composite materials
C3 ... Easily flammable	asphalt, cardboard, cellulose materials, particleboard, cork, polyurethane, polystyrene, polypropylene, polyethylene, floor fibers

2. The description of the UNI 20 boiler

The **UNI 20** water boiler is designed to heat by heating water for radiator heating in the boiler section.

The boiler is comprised of assemblies whose basic components have to be delivered in a standard version:

- The boiler part with turbulators and smoke channels, the dosing silo, the external plating, the door with a glass-ceramics component.
- The display, the automatic controls panel, the electric gear motor of the pellets transporter, the flue gas fan, the safety pressure switch, the boiler water temperature sensor, the flue gas temperature sensor, the boiler airflow sensor, and other electric equipment.

The components of hydro installation installed to the boiler are: the circulating pump, the 10-liter expansion vessel, the safety pressure valve, the air vent, the tap for charging and discharging the exchanger.

Wood pellets are 100% made from cellulose. Subjected to pressure, wood remnants are compressed into pellets 6mm in diameter and 2-3cm in length. Pellets should be properly stored in a dry place in order to ensure efficient combustion. The **UNI 20** boiler uses pellets 6mm in diameter, 5-30mm in length, and 10% in terms of moisture according to the EN14962-2 standard.

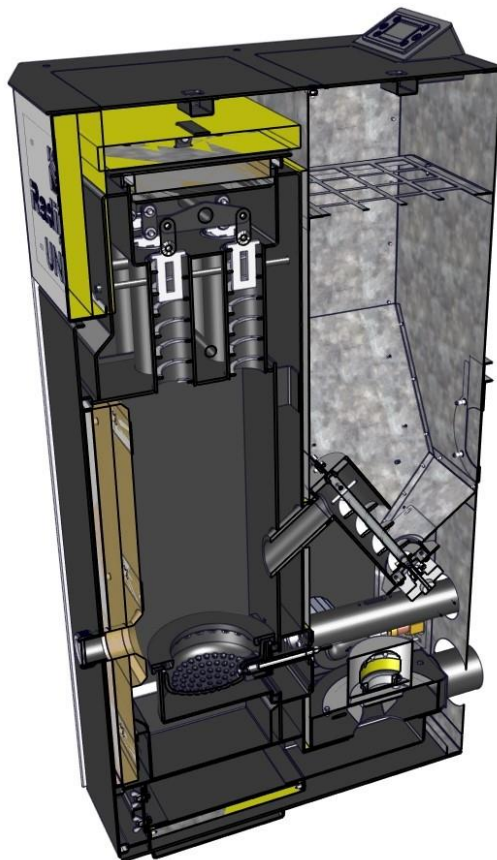

Picture 1. Cross-section of the UNI 20 boiler

3. Installing

3.1 General warnings

The boiler must be properly installed to work properly!

- ⚠ UNI 20 boiler is intended to work on central heating installations with an operating pressure of up to 2.5 bars and a maximum operating temperature of 85 degrees Celsius.**
- ⚠ The boiler door has to be closed during its operation..**
- ⚠ UNI 20 boiler comes with the fan, automatic controls, and the motor and all devices use the power supply of 230V, therefore installing improperly and handling carelessly may endanger human life with a possible electric shock.**
- ⚠ As a fuel, it uses only pellets.**
- ⚠ During the installation, please consider its weight..**
- ⚠ During the installation, stick to the law-regulated norms and regulations designed for the installation of a wood water boiler with the hot water generator, and which apply in the country where the device is installed. On the contrary, Radiator inženjering as the manufacturer doesn't take any responsibility for the consequences of such installing.**
- ⚠ In the case of certain construction changes, particularly on safety devices, lead to unwanted consequences that can impair a person's health and even endanger life Radiator inženjering doesn't take any responsibility.**
- ⚠ The device has to work with all completely functional safety devices listed and described in the following text. Glass-ceramic on the door and every smoke channel have to be in perfect condition. Perform the maintenance of safety devices exclusively upon consulting licensed persons by the manufacturer or contact the manufacturer directly.**

Radijator inženjering, as the boiler's manufacturer doesn't take any responsibility for damages caused by improper installing.

**** All national and local regulations and the European standard have to be met during the installation of the boiler.***

3.2. Safety measures and safety devices of the UNI 20 water boiler

For the safe operation of the UNI 20 boiler, the following elements are installed and it is necessary to keep them functional.:

- Air flow sensor
- The flue gas pressure switch;
- The safety thermostat of the water boiler

For the safe operation of the UNI 20 PLUS boiler, the following elements are installed and it is necessary to keep them functional.:

- Air flow sensor
- The flue gas pressure switch;
- The safety thermostat of the water boiler
- Safety pressure valve
- Automatic air vent

Air flow sensor (Picture 1): regulates the fuel combustion while the device is running.



Picture 1. Air flow sensor

The flue gas pressure switch (Picture 2): measures the pressure of gases in the furnace in case you didn't close well any of the lids (while cleaning, etc.) or didn't close the door well and, in that case, the device initiates boiler shutdown sequence and displays an error. That is the additional boiler safety protocol.



Picture 2. Flue gas pressure switch

- These conditions may lead to a worse discharge of the combustion products, especially carbon monoxide which can, in extreme cases, impair health and even lead to suffocation.

The safety thermostat of the water boiler (Picture 3):

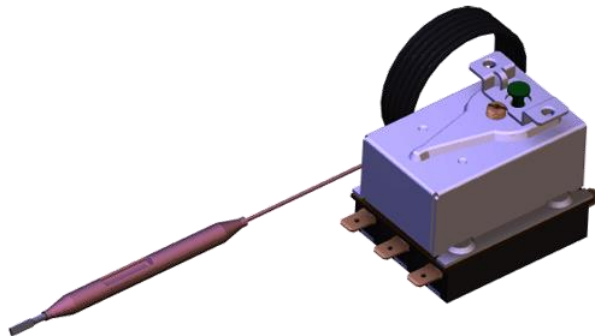

Picture 3. Safety thermostat

The safety thermostat has safety functions as a water temperature limiter in the boiler. This thermostat is so-called operational and serves to limit temperature to the user-wanted level. Safe temperature is limited to 103 degrees Celsius. This thermostat is physically installed at the back of the boiler and is electrically connected to the automatic controls.

For the safe operation of the **UNI 20** boiler, the following elements need to be installed and it is necessary to keep them functional (**they do NOT come with the boiler, only with the PLUS version**):

- The safety pressure valve;
- The automatic air vent;
- Manometar:



Picture 4. Safety pressure valve **Picture 5.** Automatic air vent **Picture 6.** Manometer

- The safety pressure valve (Picture 4) is already factory-installed to the water boiler and it has a nominal diameter of $\frac{1}{2}$ col, calibrated to the maximum value of 3 bars. Belonging to a group of pressure limiters, this safety element has to be constructed in such a way to endure short-term trespassing of both temperature and pressure, as well as to contain a certain amount of glycol in the liquid used for heating. Discharging or exhausting or part of the safety valve (if the user wants to install it) has to be made from the pipe which has a diameter at least equal to the nominal diameter of the exhausting part of the valve. It is also allowed to use no more than a single arch in the radius of $r > 3d$.

The safety valve has to have a label and the following information on it:

- the manufacturer's name;
- the safety valve's type tag /year of inspection tag;
- the nominal flow;
- information saying what thermal output the safety valve is set to;
- the highest relief pressure, that is 3 bars.

It is mandatory to inspect the operational functionality in certain periods and to have recalibration done by the certified companies. These obligations are conducted in accordance with the law of each country where the boiler is assembled. It is mandatory to keep the written document containing information on the last calibration of the safety valve.

- Install at least one other pressure relief valve on the return line.
- Along with the pressure relief valve, the breather valve belongs to the same safety group.

The automatic air vent (Picture 5) has to be installed on the highest point of the boiler and directly without any piping or any other elements between. For this purpose, there is a specially designed outlet. It is strictly forbidden to reduce this outlet's diameter in any way during the maintenance and installation of a new one.

Installing the **manometer** to the hydraulic installation (Picture 6) is also **mandatory. The one which is not factory-installed.**

⚠ The heating pump plays a vital safety function and it is factory-connected to an electric power supply through automatic controls due to safety reasons. When the water temperature in the boiler reaches the critical value of 86 degrees

Celsius, the fan stops working, but the pump necessarily turns on to exchange water through radiators.

- ⚠ **Installing a charging and discharging tap is done at the lowest point of the system. On the boiler itself, there is a charging and discharging port. Charge the installation slowly in order to irradiate the system. While the installation is being charged, check if there aren't any leaks in the central heating system.**

3.3. The operating space and position of the UNI 20 water boiler

While choosing a place where to position the boiler, you should pay attention to the following details:

- The boiler has to be as close to the chimney as possible, the supply of fresh air for combustion should also be as close as possible.
- If possible, the boiler needs to be in the biggest, central room of the heated object for the greatest effect of heating by radiating.
- The device mustn't ever be installed in the bedroom neither in the room inseparable from the bedroom by a door.
- In the room where the water boiler is installed, other furnaces or solid fuel and water pellet stoves mustn't be used. The necessary air circulation through one of these devices will probably cause difficulties in supplying air to the other device.
- The room with the boiler has to have the possibility of being ventilated and being in contact with fresh air or being connected to the room in contact with outdoor fresh air. This connection is established by using steel inflammable pipes.
- For the device's operation, a 230v and 50 Hz mains power supply is needed. Position the boiler as close to the port and, therefore, avoid extension cords.
- In the case of installing the boiler on flammable surfaces (parquet flooring, laminate flooring, wall-to-wall carpets, carpets, etc.), it is necessary to isolate the boiler from such surface by a panel made of inflammable materials (steel, ceramic, ceramic fiber isolation materials, etc.). Such panels' templates should be larger than the base of the boiler. (Picture 8)
- The boiler must be safely distanced from highly flammable materials such as wood and fabric furniture parts, curtains, plastic parts, etc. The distance has to be at least one meter from such materials.
- The boiler's distance from solid immovable objects (walls, pillars, etc.)
 - A - Front distance has to be at least 400mm.
 - B - Distance from both sides has to be at least 400mm,
 - C - Rear distance has to be at least 200mm,

These distances are necessary because of the access to the cleaning holes and because of access during maintenance interventions as well.

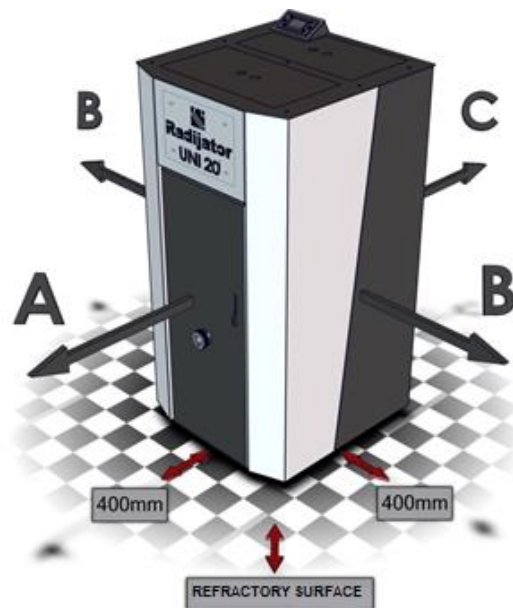

Picture 8. The representation of boiler distance from immovable objects

3.4. Installing the UNI 20 boiler to the chimney

While connecting the boiler to the chimney, there are two different installation phases:

- Installing smoke channels and supplying fresh air for combustion.
- Connecting to the chimney.

Installing smoke channels and supplying fresh air for combustion (Pictures 9 and 10):

- To connect the water boiler to the chimney, special smoke pipes certified for this purpose have to be used. Materials used to make these pipes are structural and stainless steel.
- The diameter of the smoke pipe has to correspond to the diameter of a chimney on the external end and that is 100mm. This diameter mustn't be reduced.
- The smoke pipe mustn't be used for more devices simultaneously.
- During the installation of the smoke pipe, no more than two turns at a 90-degree angle are allowed. The maximum length of horizontal sections is 2m.
- If the smoke pipe is in the proximity of flammable materials or goes through them (decorative wall layer), it is necessary to isolate it.
- Smoke pipes and elements intended to be connected to the water boiler usually have silicone O-rings on the connecting end. It is necessary to check this and, in case that there aren't any, use silicone or any other refractory kit to seal it.
- The smoke pipe has to be able to be disassembled to check how dirty it is or there has to be an inspection hole.
- If the smoke pipe doesn't go directly into a chimney but vertically up, it is necessary to install the condensation drain T-piece.

- The air for combustion has to be supplied from the outside and, for that purpose, use the pipe made of black or inox steel. The smallest allowed diameter of this pipe is 50mm.
- Unless it's possible to supply air directly from the outside, the supply from the room directly in contact with the environment must be provided. The connection of such space with the environment must be such that it isn't possible to accidentally stop the air supply (by closing doors, windows, etc.)

Connecting to the chimney (Pictures 9 i 10)

During the installation of the chimney, we differentiate two situations:

- **Situation 1:** The boiler is connected to the standard chimney (built or metal) which has its foundation and a full cross-section from the slab foundation to the top.
- **Situation 2:** The boiler is connected to the assembled metal chimney attached to the façade.

Situation 1:

- As the chimney, use ceramic or metal pipes of a circular-shaped cross-section of the minimal diameter of 130mm. The smoke pipe must be isolated by any means.
- If the chimney already exists and it has a square-shaped cross-section, the minimal dimension of that cross-section is 130x130mm.
- It isn't allowed to use the chimney to connect multiple devices.
- It isn't allowed to use ventilation holes as the chimney.
- Protect the top of the chimney with the chimney cap against the rain and winds. The distance from the cap to the chimney is 200mm.
- The chimney should come up in comparison to a roof according to suggestions in the picture (**Picture 11**). If some taller objects are close to a chimney, consider that and additionally increase the height.
- The chimney has to have a condensation drain port, as well as one inspection door. The door should always be sealed well during the operation.

Situation 2:

- In this situation, the smoke pipe has to go at least 1.5m vertically up in the room with the boiler and then burst through a wall and to be connected to the chimney.
- The smoke pipe has to have the condensation T-piece where it exits the boiler as well as the possibility to be disassembled in order to be cleaned.

⚠ WARNING: Not following the rules while setting up smoke channels and the chimney, may lead to improper operation of the boiler, and endanger human health and even their lives. The greatest danger is from poisonous gases which are the products of combustion. In these situations, where the smoke pipe and chimney, as well as the air supply, aren't executed according to the manual,

Radijator inženjering can't take any responsibility for the unwanted consequences.

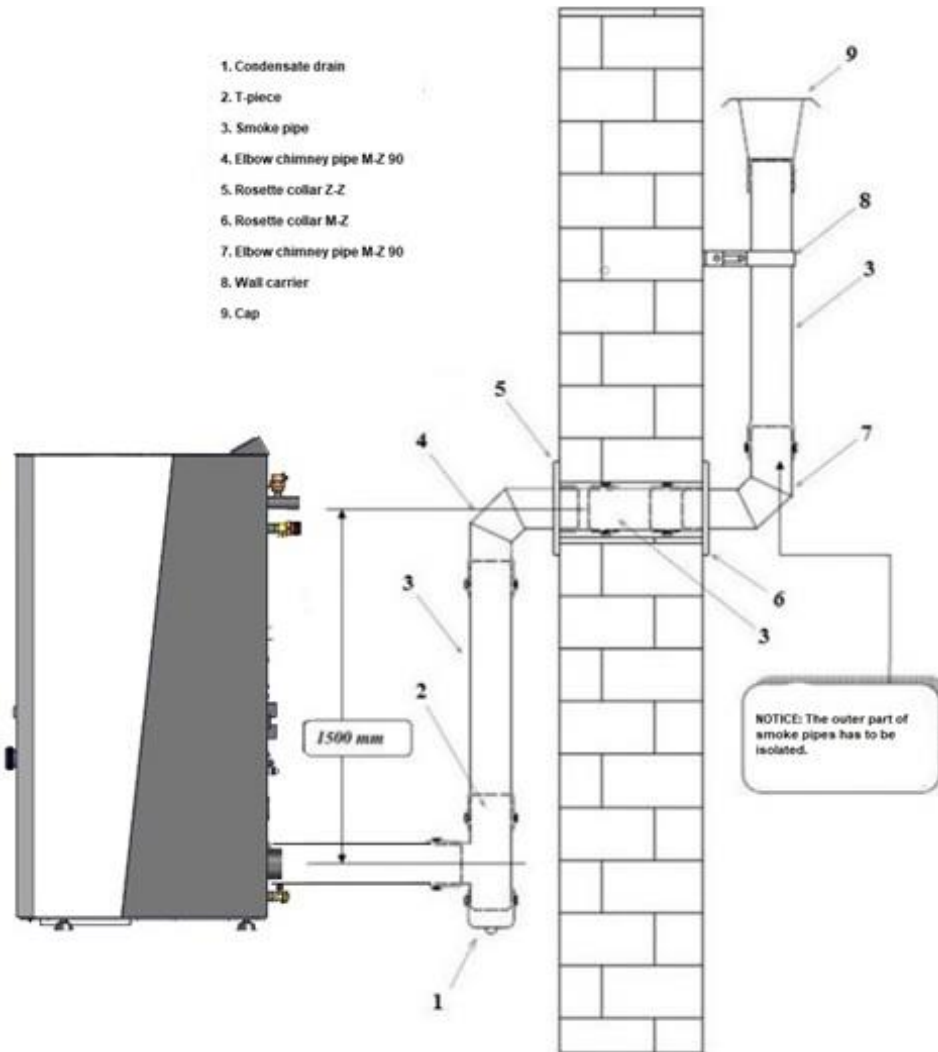

Picture 9. The representation on how to install smoke channels

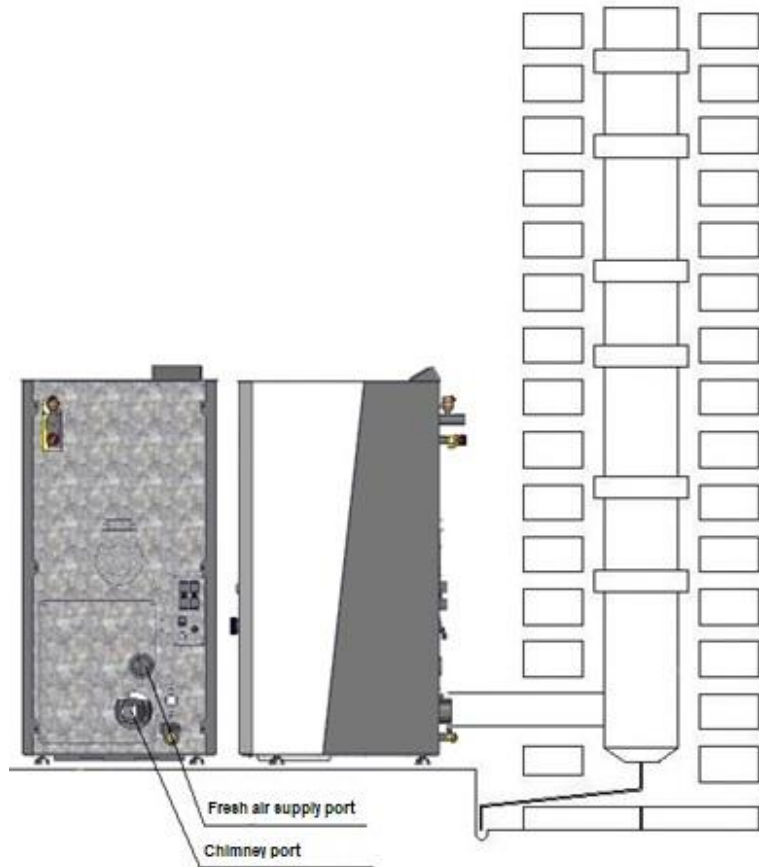

Picture 10. The representation on how to connect to a chimney

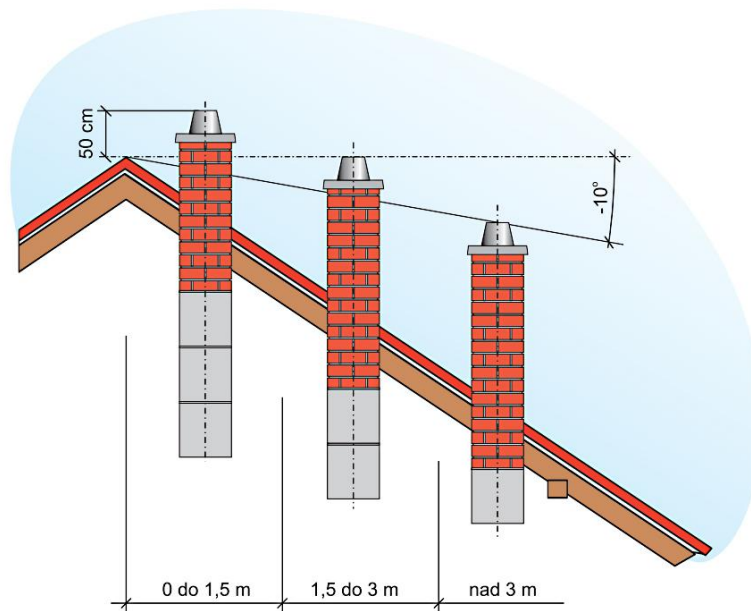

Picture 11. The representation – a suggested chimney construction method.

⚠ It is suggested to clean the chimney at least once per year to reduce the risk of fire inside. In case of fire, shut down the boiler and call the fire department.

4. The cross-section of the *UNI 20* water boiler with the description of elements

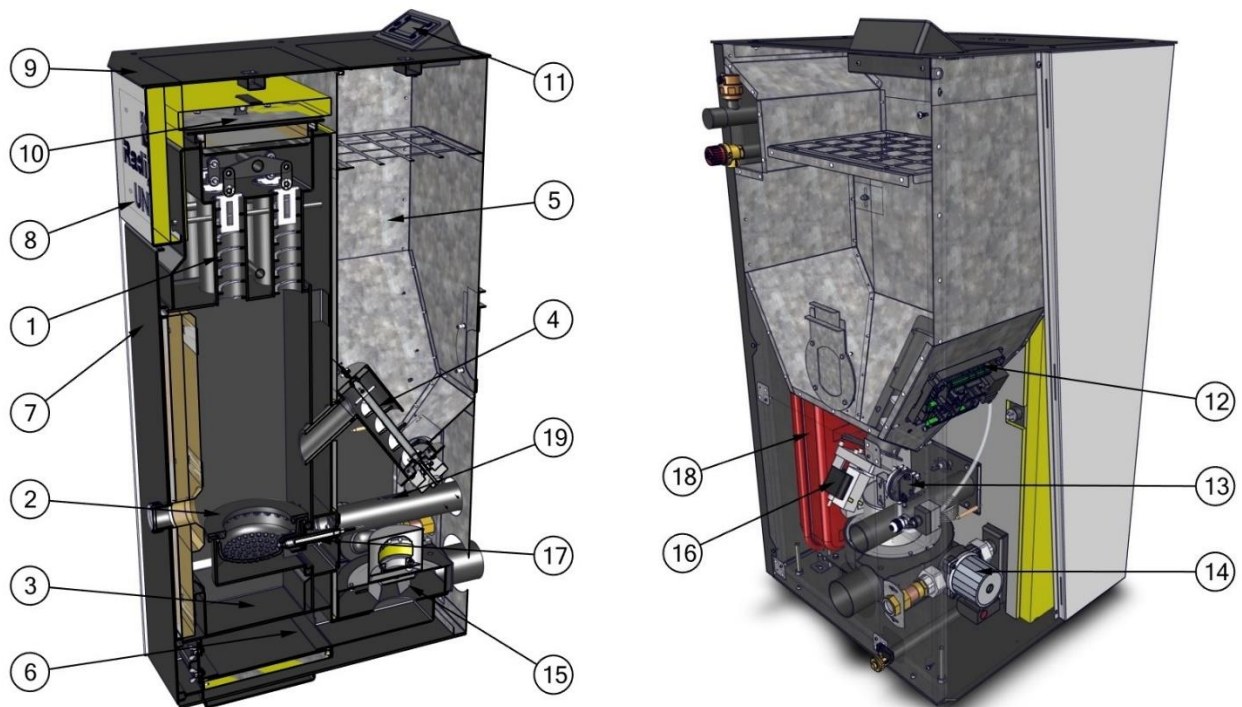

Picture 12. The cross-section of UNI 20 boiler with the description of the elements

1. Exchanger with turbulators;
2. Combustion cup;
3. Ashpan;
4. Doser;
5. Silo;
6. Smoke channels;
7. Door;
8. Plating;
9. Hob;
10. Cup of the exchanger;
11. Automatic controls display;
12. Automatic controls CPU;
13. Flue gas pressure switch;
14. Pump (only in PLUS version);
15. Fan;
16. Doser motor;
17. Heater;
18. Expansion vessel (only in PLUS version),
19. Airflow sensor.

5. The diagram on how to connect automatic controls

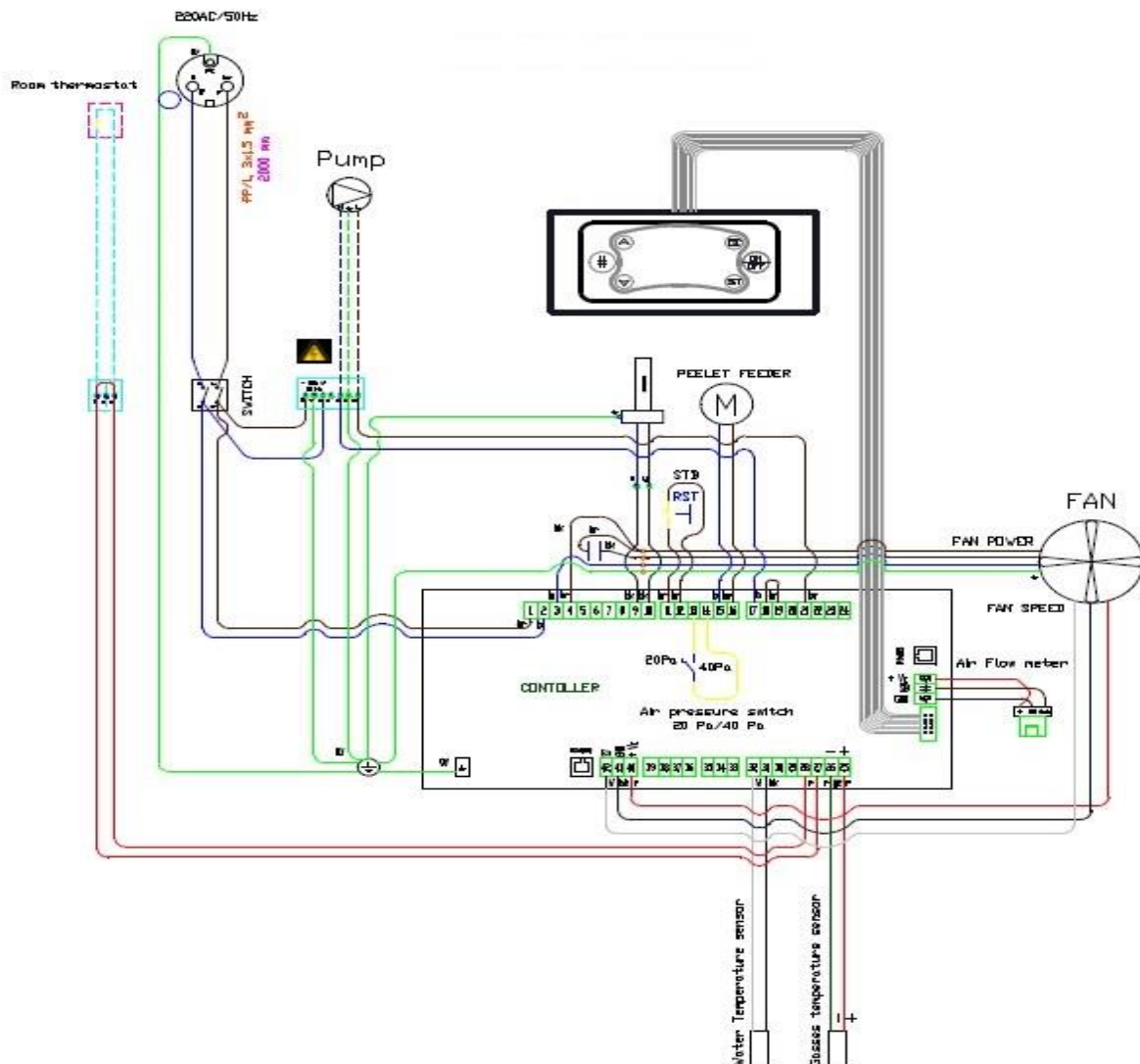

Picture 13. The scheme on how to connect automatic controls

All lines presented as dotted lines in the diagram of external connectors are conductors and need to be installed by the technician during the connecting process of external devices to the boiler's automatic controls. All connections of additional parts are done by a technician by using three-pole connectors located at the back of the boiler. The three-pole one is used to connect the room thermostat as it is displayed on the label of the connector.

- ⚠ **For room thermostats connected to the three-pole connector, it is important to utilize volt-free contact, that is without any type of 220V voltage supply. On the thermostat itself, use NC to connect (normally closed contactor without any type of voltage).**

6. Technical information table

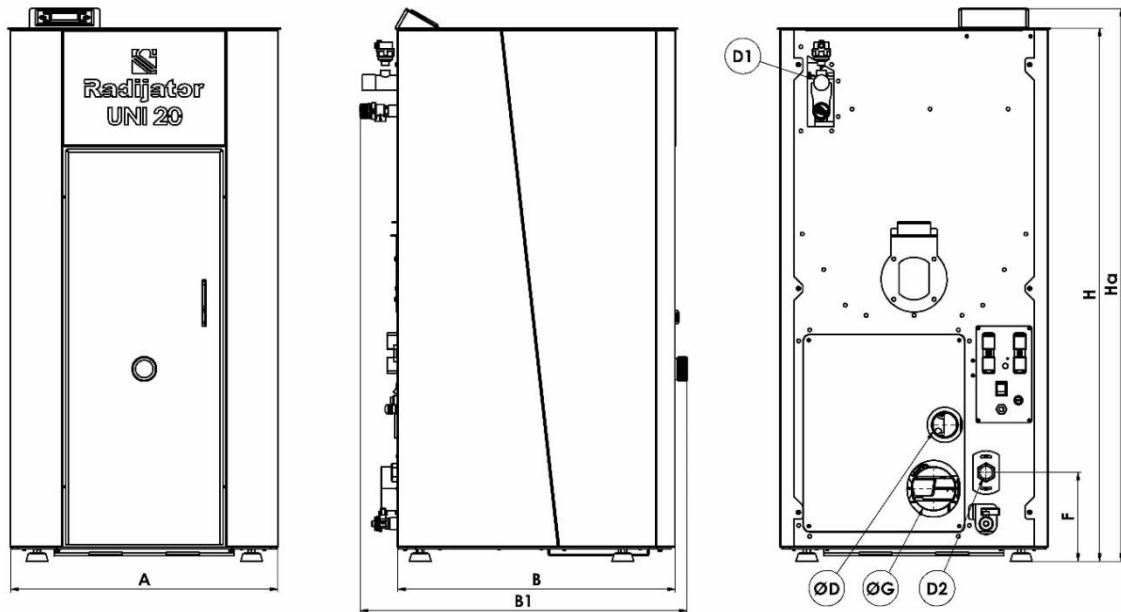

Boiler type			
	Mere	<i>UNI 20 / UNI 20 PLUS</i>	
Nominal heating power/output	kW	20	
Radiator power/output		10,3	
CO emission at nominal heating power/output	mg/Nm ³	174,9	
CO emission at reduced heating power/output		165,9	
Water volume in the boiler	L-cca	50	
Boiler weight	kg	220	
Necessary draft	Pa	10±2	
Max. operating pressure	bar	2,5	
Test pressure		4,5	
Max. temperature of hot watter	°C	85	
Min. temperatura of cold watter		60	
Degree of utilization	%	>93	
DIMENSIONS	A	mm	620
	B		630
	B1		740
	ØD		80
	E		1090
	F		205
	ØG		60,3 (2")
	H		1215
	Ha		1260
	D1		col
D2	1"		

NOTICE:

Connection D1 – hot water
Connection D2 – cold water
Connection ØG – combustion air supply

* The temperature of flue gases at nominal power for *UNI 20* (165 - 175°C).

7. The hydraulic diagram

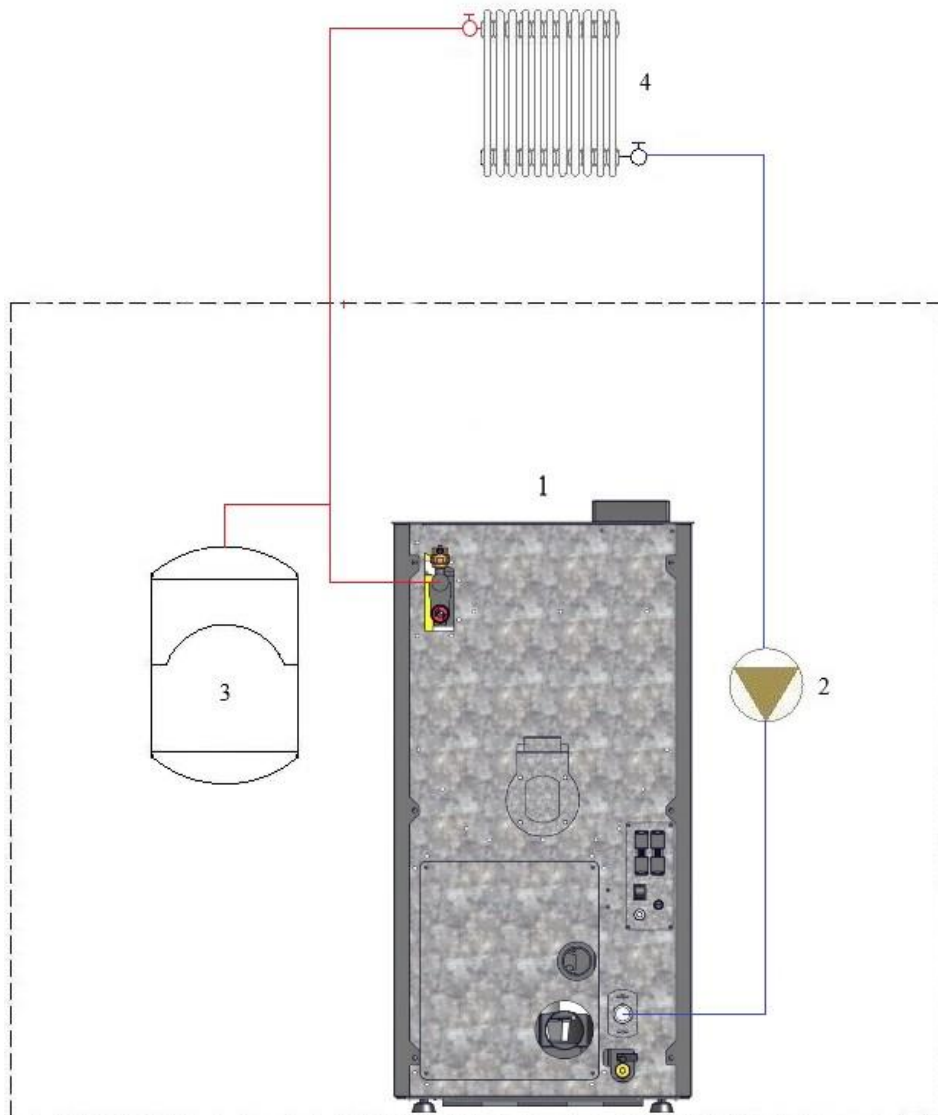

Picture 14. Connection diagram

1. Boiler;
2. Pump;
3. Expansion vessel;
4. Radiator (exchanger).

NOTICE: In a package with the boiler, the pump and 10-liter expansion vessel are not included.

- ⚠ While installing to the hydraulic installation, the boiler must be secured from exceeding maximum operating temperature and pressure in accordance in accordance with the regulated way.**
- ⚠ For the proper installation, a person who installs central heating is held responsible who connects the boiler to the hydraulic system.**
- ⚠ Radijator inženjering, as the boiler manufacturer doesn't take any responsibility for damages caused by improper boiler installing.**
- ⚠ Notice: While charging the hydraulic system, pay attention to safety elements rendered in picture 15.**

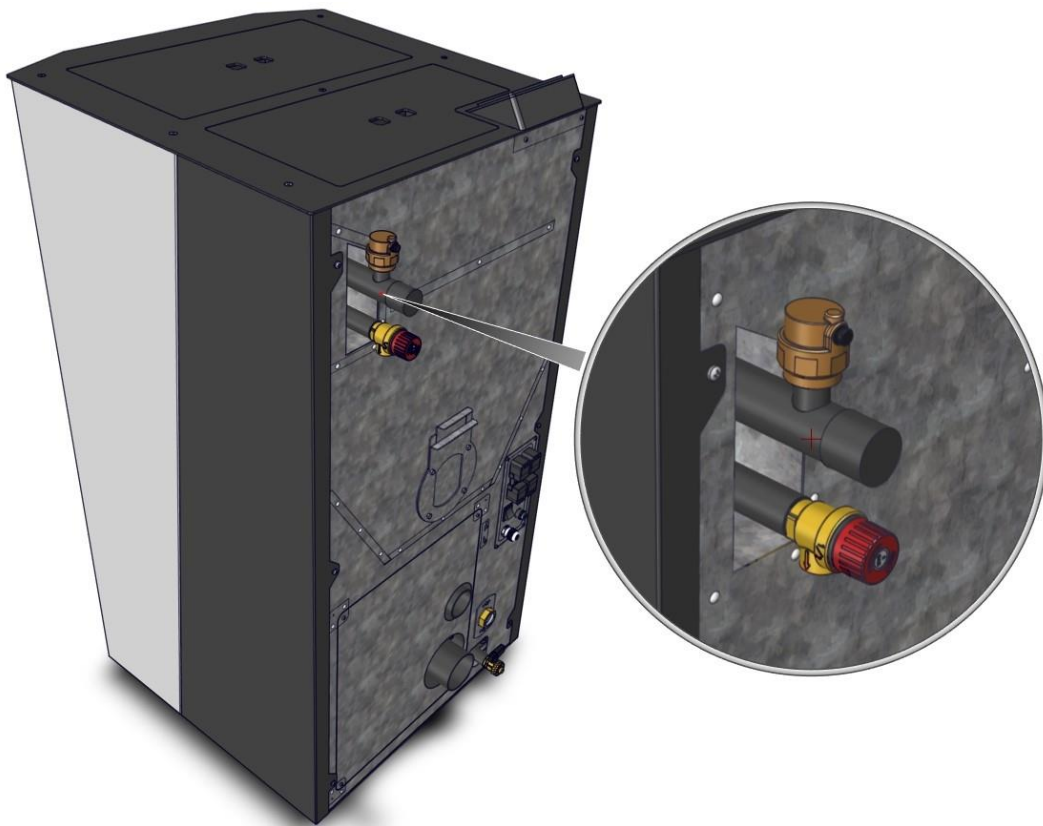

Picture 15. The representation of the air vent and safety valve at the back of the boiler

8. Starting the UNI 20 water boiler and maintenance

! The first initiation of the boiler is performed by the technician who has the certificate issued by Radiator inženjering. Training of the boiler's user is mandatory.

! In that way, that person is licensed to report the initiation time and the first initiation status of the boiler to the maintenance department in the factory, while keeping a copy of the initiation report. The warranty and user manual are given to the buyer. One copy of the warranty is sent to the manufacturer.

! If the warranty isn't followed, it isn't valid.

! Only boilers initiated by the licensed technician are subjected to the conditions of the complete 2-year warranty. If the boiler user forgets to shut the boiler down (e.g. cleaning), he/she will be able to initiate the boiler again on his/her own and the following serves as a reminder.

! Parameters for the boiler operation, available to the user, are located on the display. Other parameters in the so-called hidden menu shouldn't be changed without the consent of the technician who initiated the boiler or of the factory itself.

8.1. Automatic controls display

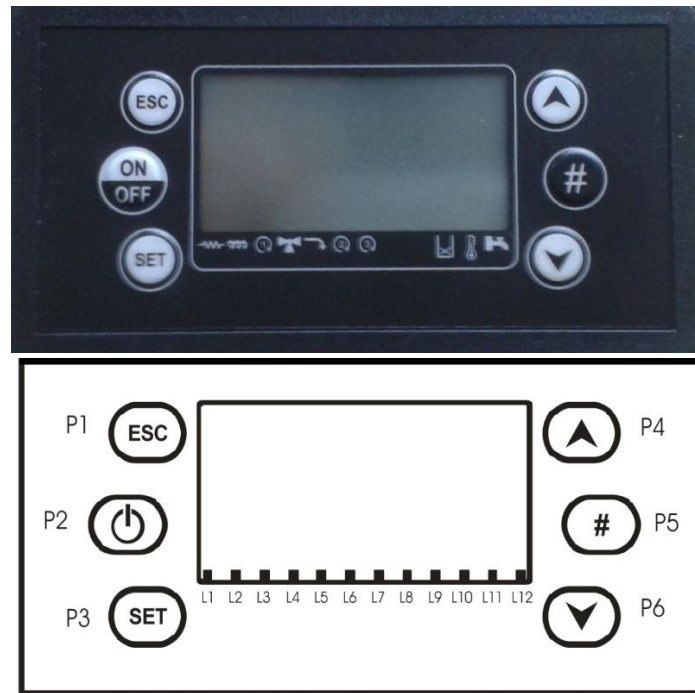

Picture 16. The Picture and representation diagram of the automatic controls display

Keys:

Function	Description	Key
Turn on/off	Turns on, turns off by pressing and holding the key for 3 seconds until the sound signal	P2
Unblock	Unblocks when the system is blocked by pressing and holding the key for 3 seconds until the sound signal.	
Change menu and sub-menu values	Changes values in the menu and sub-menu in the system.	P4 P6
Enter the menu and sub-menu	Starts the sub-menu and menu.	
Visualization	Enters and starts the visual menu.	
Esc.	Exits by pressing the key.	P1
Menu	Enters the menu or sub-menu	P3
Change	Enters the system changes in the menu.	
Confirm	Saves information in the menu.	
Reset 2-function maintenance system	Resets timer T67	P5

Diodes:

Functions	Description	Key
Heater	Diode on: Heater is functioning.	L1
Doser	Diode on: Doser is functioning.	L2
Pump	Diode on: Pump is functioning.	L3
Mixing valve	Diode on: Mixing valve is functioning.	L4
V2 port configured as the safety valve for pellets or pellets refill motor or cleaning motor	Diode on: V2 port is functioning.	L5
Combustion valve	Diode on: Combustion valve is functioning.	L6
Aux2 port configured as the safety valve for pellets or pellets refill motor or cleaning motor	Diode on: Aux2 port is functioning.	L7
Pellets level	Diode on: Insufficient pellet level.	L10
External thermostat	Diode on: External thermostat is functioning.	L11
Flow sensor*	Diode on: Request for sanitary water	L12

* only for hydro installations with flow sensor

⚠ NOTICE: Diodes L4, L5, L10 and L12 don't function in the UNI 20 boiler.

8.2. Brief instruction for the automatic controls user

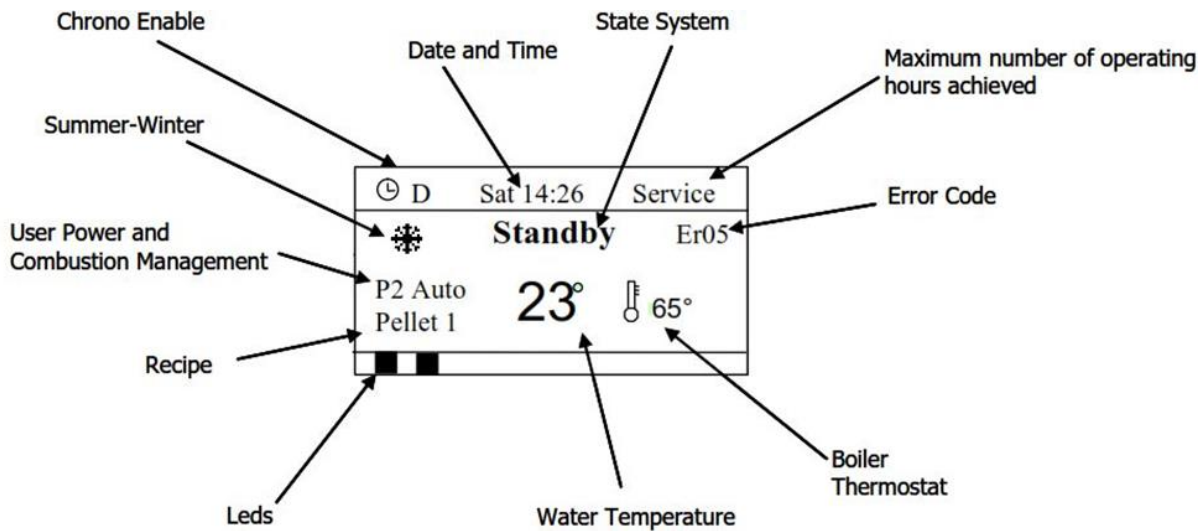

Picture 17. The representation of the LCD screen on the display

- **Reading the current status of the boiler.**

Procedure:

Press the P6 key , and after that, information appears (**Picture 18**).

Exhaust Temp	103	Izduvna temperatura [°C]
Boiler Temp	55	Temperatura vode u kotlu [°C]
Buffer Temp	55	Temperatura vode u akumulatoru* [°C]
Room Temp	35	Sobna temperatura* [°C]
Pressure	1548	Pritisak [mbar]
Air Flow	680	Protok vazduha [cm/s]
Auger	2.5	Vreme rada puža [s]
Product Code 395 – 0000		Kod proizvoda
FSYSD01000101.0.0		
FSYSF01000131.0.0		

Picture 18. The representation of the status of the boiler on the display

⚠ NOTICE: Information marked with star doesn't appear with UNI 20 boiler.

- **Entering the automatic controls MENU and the clarification of functions.**

Procedure:







Press the P3 key  , and after that, the drop-down list appears on the screen (**Picture 19**).

Menu		Description
Chombustion Power		This menu enables you to choose adjusted power for the boiler.
Boiler thermostat		This menu enables you to change the set power for the boiler.
Chrono	Modality	The menu for choosing mode: Daily, Weekly, Weekend, Disable.
	Program	
Recipe		The menu for choosing the recipe.
Time and Date		The menu for choosing time and date.
Remote control		The menu which enables the SYTX remote control
Calibration		The menu for adjusting the operating time of doser and fan speed.
Load		This menu enables the operation of the dosing system (initial and repeated charging at the boiler's initiation) provided that the system is OFF.
Summer-Winter		The menu for choosing winter or summer mode.
Language		The menu for choosing a language on the LCD panel.
Keyboard Menu		The menu for adjusting contrast and brightness on the LCD panel.
System Menu		The menu for entering the system menu.

Picture 19. Prikaz i objašnjenje MENI automatike

- **Changing the set power of the boiler.**

Procedure:

Press the P3 key  , and after that, the drop-down list appears on the screen with instantly marked first option Combustion Power. Reconfirm by pressing the P3 key.  , and after that, the representation on the screen appears again (**Picture 19**). Keys P4 or P6   adjust the set power and eventually reconfirm by the P3 key  . Return to the primary display representation (Picture 17) by pressing P1 .

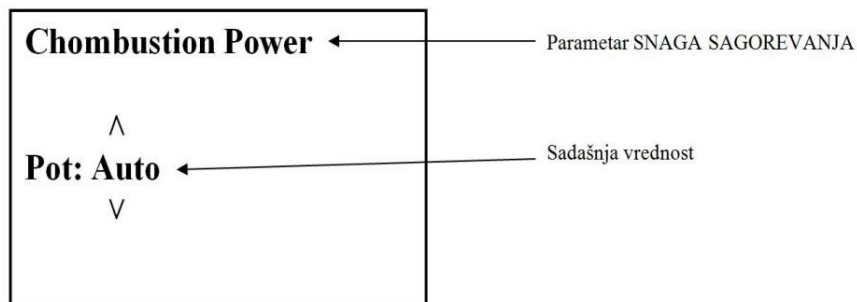









Picture 20. The representation and clarification of the display in option Combustion Power

⚠ NOTICE: The UNI 20 boiler has the maximum set power value of 3.



- **Changing the set water temperature in the boiler.**









Procedure:

Press the **P3** key , and after that, the drop-down list appears on the screen with the already marked first option Combustion Power. Keys **P4 or P6**  , bring you to the Boiler Thermostat option. Reconfirm by pressing **P3** , and then by pressing **P4 or P6**   you set the temperature and eventually reconfirm by pressing **P3** . Return to the primary representation of the display (**Picture 17**) by pressing **P1** .

- **Changing the exact time and date.**

Procedure:

Press the **P3** key , and after that, the drop-down list appears on the screen with the already marked first option Combustion Power. Keys **P4 or P6**  , bring you to the Time and Date option.

Reconfirm by pressing the **P3** key  and the setting time and precise date display shows up on the screen, in which, by using **P4 or P6** keys   you confirm the command and change its values again by using keys **P4 or P6**  you confirm the command and change its values again by using keys **P4 or P6**  . Upon choosing the desired value, it is confirmed by the **P3** key . To exit and return one step back, use the **P1** key .

Set time-programmed mode for initiating and shutting down the boiler.

(use this option ONLY IF YOU HAVE SET THE EXACT TIME AND DATE PREVIOUSLY).











In terms of time-programmed mode, in the option itself there are two sub-options and these are **Modality** and **Program**.

Modality option serves to choose programming method, whether you will use it on a daily level, each day separately (**Daily**) (e.g. Monday, Tuesday, Wednesday...Nedelja), on a weekly level (Weekly) (from Monday to Sunday), and on a weekend level (**Week-end**) (from Monday to Sunday - separately and from Saturday to Sunday - separately). Also, you can turn off the Chrono option completely (**Disable**).

Program option serves to program the aforementioned options Daily, Weekly and Weekend, more precisely to set precise time for the boiler to start and stop working..



Procedure:

Firstly, you should decide how to program the starting and stopping time, whether it will be a daily, weekly, or weekend option. If you choose one of the listed, the choice will be done the following way.

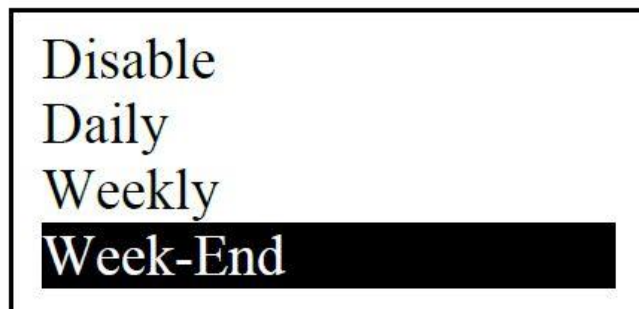



Press key **P3** , and after that, the drop-down list appears on the screen with the already marked first option Combustion Power. Keys **P4 or P6**  , bring you to the option Chrono. Reconfirm by pressing the **P3** key  (two options appear, **Modality** and **Program**), and then by **P4 or P6** keys   you reach the desired option **Modality** and confirm it by the **P3** key . After that, in the sub-menu you get to options **Daily, Weekly, Weekend** and **Disable** (shown on picture 21). By pressing **P4 or P6** keys   choose one of them and confirm by pressing the **P3** key .



Picture 21. The representation of the display upon choosing option MODALITY

Upon choosing the programming method, you automatically go back to the representation of the display Modality and Program. By pressing keys **P4 or P6**   you switch to the option **Program** and confirm it by the **P3** key .

In this option, you program the exact time to start and shut down the boiler previously chosen in the option **Modality**. The examples of programming are shown in (**Picture 22, 23, and 24**).

For further switching, use keys **P4 or P6**  , for confirmation use the **P3** key , for confirmation of the selected value use the **P5** key , and to return one step back the **P1** key .

Daily	Monday	Monday
Weekly	Tuesday	ON OFF
Week-End	Wednesday	09:30 11:15 ✓
	Thursday	00:00 00:00
	Friday	00:00 00:00

Picture 22. The representation of the display upon choosing option Daily

Daily	Mon-Sun
Weekly	ON OFF
Week-End	08:30 13:15 ✓
	20:00 22:00
	00:00 00:00



Picture 23. The representation of the display upon choosing the option Weekly





Daily	Mon-Fri	Mon-Fri
Weekly	Sat-Sun	ON OFF
Week-End		10:00 12:15
		14:00 16:00 ✓
		00:00 00:00

Picture 24. The representation of the display upon choosing option Weekend

- **Change Recipe.**



Procedure:





Press key **P3** , after that, a drop-down list appears on the screen, where the first option is immediately highlighted **Chombustion Power**. Keys **P4** ili **P6**  , gets you to option **Recipe**.

Press again key **P3** , after that the display appears with the marked number which is the current recipe. Keys **P4** ili **P6**   set the set recipe (lower setpoint number = lower doser loading times in operating modes, higher setpoint number = higher doser loading times in operating modes) and finally confirm again with the key **P3** . Return to the basic display by pressing **P1** .





- **Auger operating time and fan speed menu (Calibration).**

Procedure:





Press key **P3** , then a drop-down list appears on the screen, where the first **Chombustion Power** option is immediately highlighted. Buttons **P4** ili **P6**  , gets you you to the option **Calibration**.

Confirm by pressing **P3** , after that, the **Auger Calibration** or **Fan Calibration** selection display appears on the display. The display will be marked **Auger Calibration**, with the keys **P4** ili **P6**   select what you want to change and confirm with the key **P3** .

Changing the doser work time Auger Calibration

If you have chosen **Auger Calibration** the display will indicate the current calibration value (Set: 0, mostly 0), with the key **P4**  increase the value of the dosing time, and the key **P6**  you reduce the dosing time. Values are from -5 to 5, (lower calibration setpoint = lower doser loading times in operating modes, higher calibration setpoint = higher doser loading times in operating modes), when you select a numerical dosing value, confirm again with the key **P3** . Return to the basic display (Figure 17) by pressing the button **P1** .

Fan Calibration fan speed change

If you have chosen **Fan Calibration** the display will indicate the current calibration value (Set: 0, mostly 0), with the key **P4**  increase the value of the fan speed, and the button **P6**  you reduce the fan speed value. Values are from -5 to 5, (lower calibration setpoint = lower fan speed in operating modes, higher calibration setpoint = higher fan speed in operating modes), when you select the numerical fan speed value confirm with **P3** . Return to the basic display (Figure 17) by pressing the button **P1** .

8.3. Starting the *UNI 20* boiler

- **STEP 1:** The boiler is connected to the hydraulic system.
- **STEP 2:** Insert pellets into the silo.
- **STEP 3:** Inspect if all lids are tightly closed and if the boiler door is properly closed.
- **STEP 4:** Start the boiler, the switch is located at the back of the boiler.

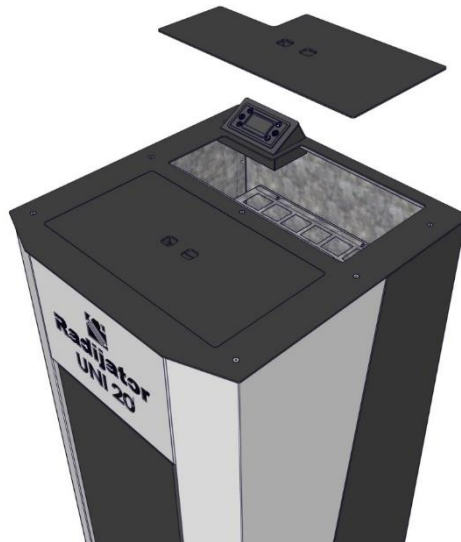



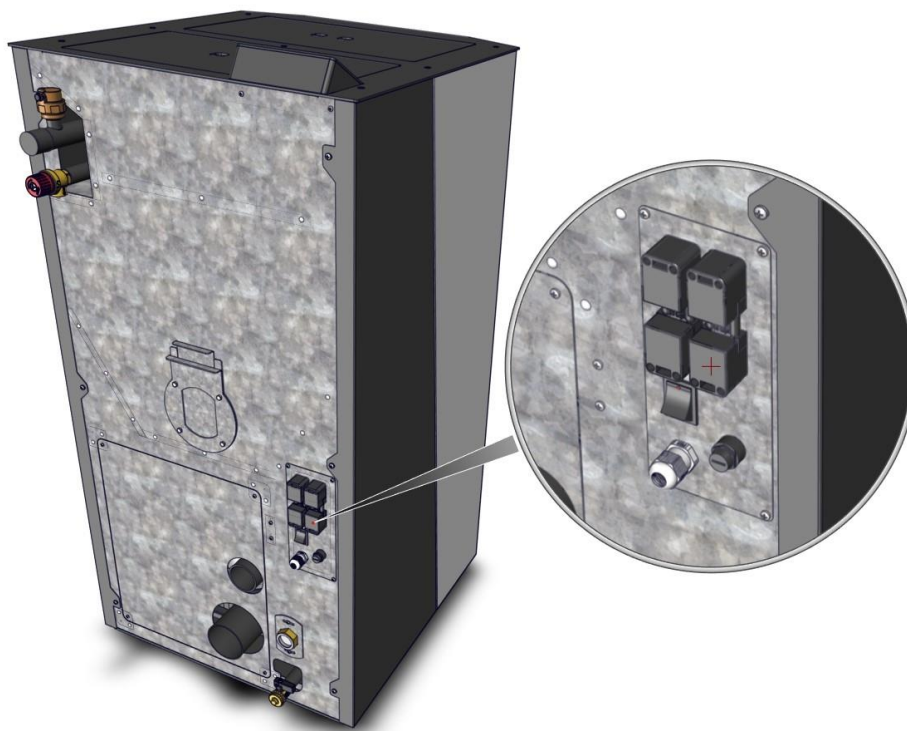







Picture 25. The representation of the pellets insertion opening



Picture 26. The positional representation of the cable grommet, main switch as well as the safety thermostat

STEP 5: Start the dosing system so that the first pellet grains can fall into the combustion cup. (This procedure can only be performed if the automatic controls are in OFF mode (picture 17 system status))

Procedure:

Press the **P3** key , and then, by pressing **P4** or **P6** keys   in the sub-menu, you get to the LOAD function, confirm by pressing the **P3** key , by pressing keys **P4** or **P6**   switch from OFF to ON, confirm with the **P3** key . By confirming with the key, the doser initiates until the first pellet grains don't start falling into the combustion cup. Subsequently, by pressing **P4** or **P6** keys   you are taken from ON to OFF, confirm by the **P3** key . At that moment, the doser stops working. By pressing the **P1** key  exit the sub-menu.

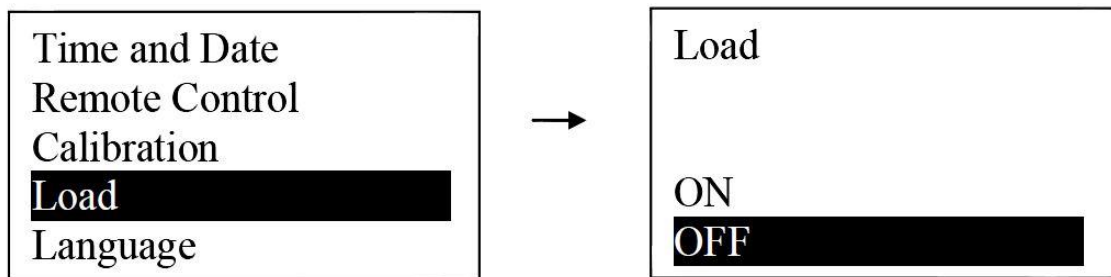

Picture 27. The representation of the display upon selecting the LOAD function

➤ **STEP 6:** Starting the boiler.

Procedures:

Press the **P2** key , hold it for 2-3 seconds until you hear the sound signal. Then, the 'Ignition' message appears on the display (picture 16 – system status). The boiler starts working.

In situations when pellets meet standards and all other chimney and airflow conditions are met, the combustion process starts in 5 to 10 minutes..

During the first ignition, somewhat excessive smoke and sharp smells are to be expected until factory anti-corrosion coatings aren't completely dry, more precisely combusted.

The identical procedure is used to shut down the boiler, that is by pressing the **P2** key  until the sound signal we are entering the shutdown phase.

➤ The room thermostat can be connected to automatic controls. In this case, it is important to set the room temperature which is the main parameter for the boiler to operate and for water in the boiler (70°C). When the room thermostat is activated, the

boiler requires to achieve the room temperature, being limited to the set temperature of water in it. The boiler can stop working before reaching the set temperature of the room thermostat and in this case, the set water temperature in the boiler should be raised to, for example, 70°C.

Warning: It is mandatory to analyze flue gases upon finishing the installation of the boiler. Measure the percentage of oxygen (O₂).

8.4. Start-up and working errors of the *UNI 20* kotla.

All possible errors in the initial working stage, more precisely during firing, even during its operation are reported on the display by the automatic controls. (**Picture 17**- error signaling ALARM).

Error tags and clarifications are given in the following table.

Er01	Error – High voltage 1. The safety thermostat is activated.
Er02	Error - High voltage 2. The safety air pressure switch is activated.
Er03	Error – Shutting down when the temperature of smoke channel gases is below anticipated.
Er04	Error - Shutting down when the temperature of water is above the set value.
Er05	Error - Shutting down when the temperature of the smoke channel gases exceeds the anticipated value.
Er07	Error - Encoder. This error occurs due to the shortage of the encoder signal.
Er08	Error - Encoder. This error is related to the bad encoder loading
Er09	Error – Low water pressure
Er10	Error – High water pressure
Er11	Error – Real time , sistemska greška
Er12	Error – Shutting down due to the failed ignition
Er15	Error – Lack of voltage
Er17	Error – on the regulator of the airflow sensor
Er18	Error – Shortage of pellets
Er39	Error - Malfunctioning regulator of the airflow sensor
Er41	Error – The minimum airflow isn't achieved
Er42	Error – The maximum airflow is above anticipated.

All possible operating problems and failures of this device can be divided into two large groups.

- **Group I.** The operating failure during the first ignition, more precisely during the very first ignition upon purchasing the boiler or the first initiation during a day.
- **Group II.** The failure which occurs if the boiler worked already and the display had a notification (Run Mode), but after reaching the set temperature and being in standby mode loses the combustion continuity.

Group I

The most frequent signalization on the display, related to this group of errors **are Er02, Er12, Er41.**

During the first ignition after the installation of the boiler on the hydro installation, the instructions from the section "Start of boiler operation" should be followed.

Especially, pay attention to the smoke channel (diameter, number of arches, sealing, ...) as well as to the chimney (diameter, height, isolation, sealing of the inspection holes, the amount of dirt in the chimney, etc.).

Error Er02

When switching on the boiler, in the phase of checking the boiler system "Check Up", if the operating conditions are not met, the display error Er02 (High voltage 2. Safety air pressure switch activated), the boiler goes into the phase of shutdown (Extinguishing). In this case, the following causes should be checked:

Possible cause 1.

- **PROBLEM 1.** The boiler door is not properly locked or the sealing openings in one of the boiler cleaning openings are not well sealed.
- The procedure of resolving **PROBLEM 1.** Check the seal on one of the boiler cleaning inspection openings, check that the boiler door is properly locked, after closing the boiler door, wait about 30 seconds before restarting the boiler.

Possible cause 2.

- **PROBLEM 2.** U toku rada kotla otvarana su vrata kotla.
- The procedure of resolving **PROBLEM 2.** Do not open the boiler door during operation, they may only be opened when the boiler is not running. (OFF)

Error Er41

When switching on the boiler, in the phase of checking the boiler system "Check Up", if the operating conditions are not met, the error **Er41** (Minimum air flow not reached) appears on the display, the boiler goes into the phase of shutdown (Extinguishing). In this case, the following causes should be checked:

Possible cause 1.

- **PROBLEM 1.** There are no pellets in the silo.
- The procedure of resolving **PROBLEM 1.** Pour the pellets into the silo.

Possible cause 2.

- **PROBLEM 2.** The boiler door is not properly locked or the sealing of the boiler cleaning openings is not well sealed.
- The procedure of resolving **PROBLEM 2.** Check the seal on one of the boiler cleaning inspection openings, check that the boiler door is properly locked, after closing the boiler door, wait about 30 seconds before restarting the boiler.

Possible cause 3.

- **PROBLEM 3.** Too many deposits or unburned pellets have accumulated in the combustion cup during the previous operation of the boiler.
- The procedure of resolving **PROBLEM 3.** Clean the pellet combustion cup.

Possible cause 4.

- **PROBLEM 4.** Too many deposits have accumulated in the flue ducts during the previous operation of the boiler.
- The procedure of resolving **PROBLEM 4.** Clean the boiler flue ducts.

Possible cause 5.

- **PROBLEM 5.** Dirty chimney, too much deposits have accumulated.
- The procedure of resolving **PROBLEM 5.** Clean chimney.

Error Er12

If after the first ignition attempt there is no significant flame and a more serious increase in flue gas temperature, an **Er12** error (failed ignition) appears on the display, and the boiler goes into the extinction phase. In this case, the following causes should be checked:

Possible cause 1.

- **PROBLEM 1.** Poor quality pellets. Low power pellet, increased humidity.
- The procedure of resolving **PROBLEM 1.** Take pellets of proven quality and try.

Possible cause 2.

- **PROBLEM 2.** The air temperature (which was brought to the boiler for combustion and ignition) is extremely low (below zero).
- The procedure of resolving **PROBLEM 2.** Raise the preheater heater preheating time, t02, by 10 seconds.

Possible **cause 3.**

- **PROBLEM 3.** The mains voltage to which the boiler is connected is significantly less than 220-230V, so the power of the heater is lower.
- The procedure of resolving **PROBLEM 3.** Raise the preheater heater preheating time, t02, by 10 seconds. If this measure does not give results then connect the mains voltage rectifier.

Possible **cause 4.**

- **PROBLEM 4.** The amount of pellets in the combustion chamber is insufficient to move the boiler to work.
- The procedure of resolving **PROBLEM 4.** Increase the initial dosing of pellets t03 by 5 to 10 seconds, if there are not enough pellets again, mechanical problems with the pellet conveyor are possible. Check the correctness of the dispenser.

Possible **cause 5.**

- **PROBLEM 5.** After the fixed loading phase (t03), in phases t04 and t05 the flame is established, but during the ignition it is not possible to switch to stabilization (Stabilization), so the flame becomes weaker and weaker so that the flue gas temperature drops and Extinguishing. This problem is due to the different quality of the pellets.
- The procedure of resolving **PROBLEM 5.** Increase the time of fixed loading of pellets t03 (by 5 to 10 seconds), and if necessary the time of loading pellets in the second phase of ignition C10. It is recommended to extend this time carefully, first by 0.1 or 0.2 seconds.

Possible **cause 6.**

- **PROBLEM 6.** There are situations in which the boiler passes the ignition phase, but in the stabilization phase it is clear that there are not enough pellets. By checking the flue gases, the boiler will not switch from the Stabilization phase to the Run mode. This problem is due to the different quality of the pellets.
- The procedure of resolving **PROBLEM 6.** This problem is eliminated by extending the loading time in the CO2 stabilization phase. It is recommended to extend this time carefully, first by 0.1 or 0.2 seconds, and if that is not enough, then by another 0.1, etc. After that, combine the problem solving with the procedure from the next point.

Possible **cause 7.**

- **PROBLEM 7.** The boiler is connected to a room thermostat. Increasing the set temperature on the room thermostat does not move the boiler to the ignition phase (Ignition) and does not activate the ignition heater.

- The procedure of resolving **PROBLEM 7**. Check that the room temperature is really lower than the set one. Also check the time programming of the room thermostat and finally check the correctness of the room thermostat.

Group II

The most common display signals related to this type of error are **Er03, Er05**.

Error Er03

Possible cause 1.

- **PROBLEM 1**. The boiler was in run mode, but there was a drop in flue gases during operation, the boiler goes into the phase of extinction (Extinguishing).
- The procedure of resolving **PROBLEM 1**. In such cases, it is necessary to check whether there are pellets in the silo, or something has fallen into the pellet dispenser, so he could not put the pellets in the combustion cup.

Possible cause 2.

- **PROBLEM 2**. The boiler is in run mode, but over time there is an increasing accumulation of slag and ash at the bottom of the combustion cup. Over time, unburned pellets fill the combustion cup and the flame is reduced and the boiler goes to extinction.
- The procedure of resolving **PROBLEM 2**. It is best to increase the fan power in all modes via the Calibration-Fan Calibration function or to reduce the pellet dosing via the Calibration-Auger Calibration function. If that didn't help to reduce the accumulation of slag and ash on the bottom of the combustion cup, choose another recipe for combustion (numerically lower than the current value) via the Recipe function. (The procedure is explained in section - 8.2. Short instructions for the user of automation)

Error Er05

Possible cause 1,

- **PROBLEM 1** the boiler is running, but during operation there is a standstill and signaling on the Modulation display, and then a safety shutdown (Extinguishing). Finally the display signals an Er05 error.
- The procedure of resolving **PROBLEM 1**. This is because the flue gases are too hot. The most common reasons are dirty boiler, too strong chimney, excessive loading of pellets due to the characteristics of pellets, etc.

8.5. Maintenance and cleaning the *UNI 20* kotla

The *UNI 20* boiler requires daily and periodic cleaning..

Everyday cleaning is related to the space of the furnace itself, more precisely the combustion cup, where we, by ejecting ashes constantly, enable more efficient work of electric heaters for igniting and more efficient combustion, that is more air through the slots on the cup. During the day, ash already starts building up on the floor, space around the furnace itself..

It is also necessary to clean the pipes of the exchanger every day by using the lock door handle and simply by moving the lever back and forth we control the mechanism which moves turbulators and cleans the pipes of the turbulator. (**Picture 28**).

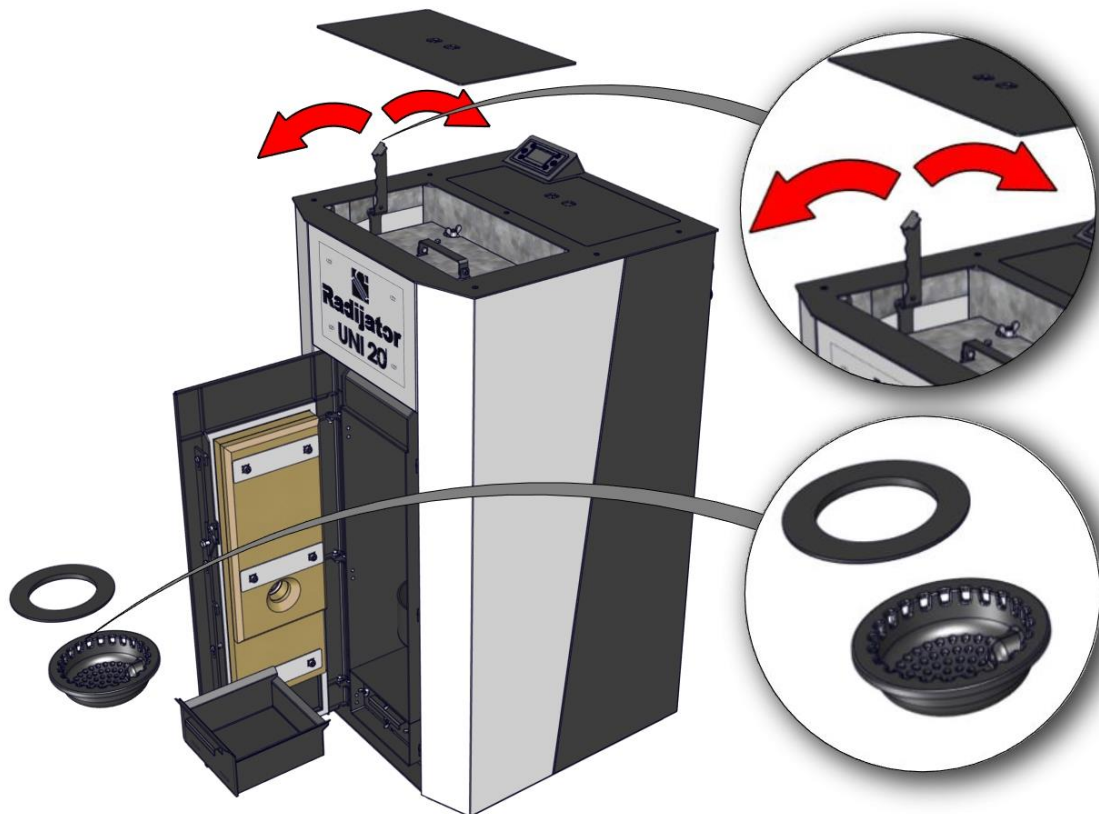

Picture 28. *Cleaning the combustion cup and turbulator*

It is necessary to empty the ash pan of the furnace every 3 to 4 days..

Once every two weeks, it is necessary to clean layers on the furnace walls. This provides a higher transmission rate because one millimeter of tar and soot layers reduces conductivity by 5%.

Open the upper cleaning lid and clean all reachable spots above the turbulator. The frontal inspection lid of smoke channels should also be opened, remove the M profile from the smoke channels and clean the entire interior space of the smoke channels and the fan box from layers of soot and ash (**Picture 29**).

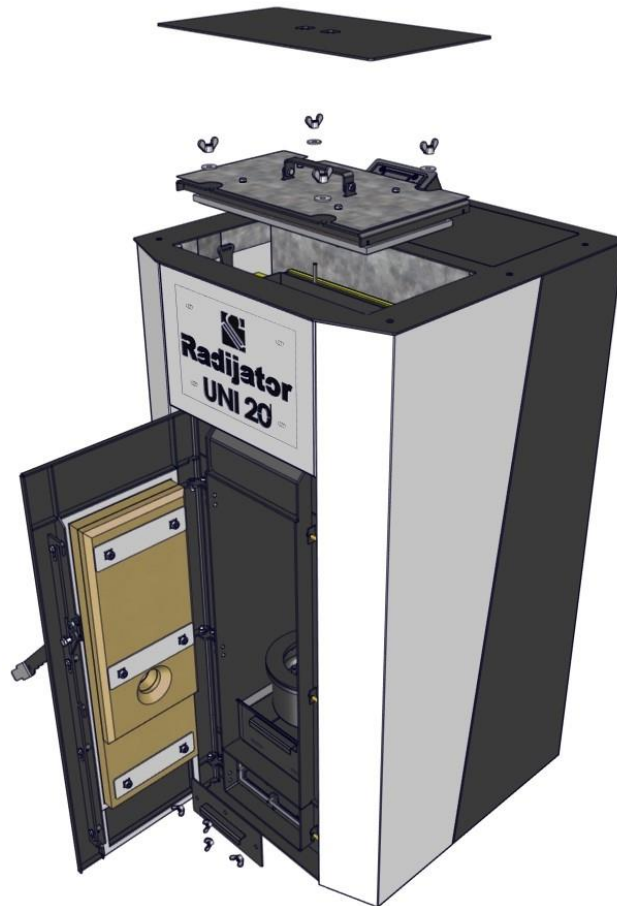

Picture 29. The representation of elements being disassembled during cleaning

If condensation appears inside while using the boiler, it is necessary to remove it and the entire boiler should be coated from inside with basic cleaners or at least with the aqueous solution of builders' lime. That way, the neutralization of acid due to condensation is done.

- ⚠ During service and maintenance of the boiler, remove it from the power supply.***
- ⚠ Return the M profile inside the smoke channels, for the purpose of stable boiler operation.***
- ⚠ This way, conserve the boiler imperatively at the end of the heating season. In that situation, close all holes on the boiler to avoid air circulation through the boiler because that can result in the appearance of moisture inside.***
- ⚠ Servicing the boiler is one of the most important factors for its long working life. Between two seasons, it is particularly important to clean the boiler and neutralize the acid as described.***

8.6. Nameplate

The nameplate is located on an easily visible spot on the boiler and contains the following (see the picture in the section LABELS) Technical data from the label:

- Manufacturer (Radijator inzenjering)
- Serial number of the boiler (example: N°:170616003)
- Year of manufacture (example: 2020)
- Boiler type (UNI 20 15 or UNI 20 20)
- Degree of efficiency (Nominal - 93%, Reduced - 94%)
- Operating pressure (2,5bar)
- Electrical voltage (230V)
- Frequency (50Hz)
- Nominal electric power (500W)
- Fuel (Pellets - C1)

	<i>UNI 20</i>
Nominal heating power	20 kW
Reduced heating power	10.3 kW

5. The importer label
6. OEEO
7. Other tags on the boiler



9. Warranty

9. Radiator inženjering covers different warranty periods for various parts (as listed in the following text) only if the following warranty conditions are met:

- The boiler has to be connected according to the listed hydraulic schemes from the technical manual, especially pay attention to the installation of the boiler to a chimney and its positioning. (refer to point 3)
- The boiler has to be connected to the chimney of the regulated cross-section, proper isolation, and height. (refer to point 3.4)
- The smoke channel from the boiler to the chimney has to be done according to the technical manual.
- The boiler has to have listed electrical connections installed from the technical manual, especially the characteristics of the room thermostat, the characteristics of the mains voltage which must be within certain limits.
- The user must follow the listed instructions on how to use and do maintenance. (refer to point 8)

10. Warranty statement

We state:

- that the product has regulated and declared quality properties.
We oblige to, on the request of the buyer if he/she timely within warranty period submits the repair request, cover all repair costs so that the product will operate according to its declared properties,
- that the product will work flawlessly within the warranty period provided that the use, operation, and installation instructions are followed,
- that we will be ready to remove all product malfunctions and have all necessary spare parts in stock within the warranty period,
- **the warranty period starts from the DAY OF PURCHASE AND LASTS 60 MONTHS OR 72 MONTHS FROM THE PRODUCTION DATE (the production date is located on the label at the back of the boiler),**
- **THE 60-MONTH WARRANTY APPLIES ONLY IF THE BOILER IS REGULARLY SERVICED BY THE RADIJATOR INZENJERING CENTRAL MAINTENANCE in the period listed for it (hereinafter),**
- **the warranty applies if the warranty paper is certified by the seller and if the purchase date is written and if the receipt is attached. IT IS ALSO IMPORTANT TO HAVE INITIATION WARRANT (certified by the licensed maintenance department)**

11. The 1-year warranty period applies to the following parts:

- bearings,
- electrical heater for ignition.

12. The 2-year warranty period applies to the following parts:

- fan,
- display, automatic controls of the boiler with safety thermostat and other electrical parts (air pressure switch),
- probe for smoke channel gases,
- probe for boiler water temperature,
- gear motor,
- worm coil,
- combustion cup,
- electric connectors,
- isolation materials on doors and cleaning holes,
- turbulators and cleaning mechanism,
- expansion vessel, safety valve, vent valve, and bearing (slide bearing).

13. Warranty period doesn't apply:

- unless the regular maintenance is done after each heating season,
- in case of the replacement of parts on the annual maintenance in accordance with the instructions,
- in case of malfunctions caused during transport and during use (solid objects),
- if the product was installed unprofessionally, contrary to the valid regulations in that aspect,
- if the buyer used the product above the declared properties in normal circumstances,
- to the boiler's door glass,
- to the boiler's door handle;

14. Warranty period isn't valid:

- if it is found out that malfunctions were removed by an unauthorized person or an unauthorized maintenance department,
- if during the repair the original parts weren't used and installed,
- upon the expiration of the warranty period.

15. When reporting malfunctions, it is mandatory to provide the following information:

- name and type of the product,
- date of purchase,
- factory or workshop number of the boiler,
- brief malfunction description, that is the description of a defect,
- exact address and contact number, mail.

16. Regular yearly maintenance

Regular maintenance is done at the end of each heating season from April 15th to August 31st and is charged according to the set price list of Radijator inženjering company. The maintenance procedure, performed by technicians performing regular yearly maintenances authorized by the company, include the following operations:

⚠ NOTE: The servicing technician is obliged to inspect all listed parts (from the list) of the dozer and exchanger and if it comes to the replacement of any parts the user receives the aforementioned warranty and the additional 12-month warranty for the boiler body (exchanger) as well. The warranty can be extended up to 5 years from the initiation date. The warranty and extension can be done by the person sent by the central maintenance department of Radiator inženjering. The warranty isn't valid to unchanged parts upon completing maintenance.

- Disassembling the pellets transporter, inspecting its validity, and inspecting the validity of bearings and lubrication;
- The bearing mustn't have hindered rotation. On the contrary, the bearing gets replaced. Should it be discovered that the bearing was damaged because of dropping a solid object into the pellets transporter (mistake of the user or pellets manufacturer), Radiator inženjering charges the value of the bearing.
- Disassembling the combustion cap of the furnace and cleaning furnace space beneath the cup. The inspection of the cup;
- Remove the probe of smoke gases and clean it from the layers;
- Inspecting the fan;
- Inspecting the door sealing;
- Inspecting the maintenance of the boiler's exchanger.
- Cleaning smoke channels.

GARANTNI LIST / GUARANTEE LIST

Tip kotla / Boiler type

Fabrički broj / Factory No.

Garantni rok / Guarantee period

60 MESECI/ 60 MONTHS

Datum proizvodnje /
Date of manufacture

Potpis ovlašćenog lica /
Signature of Authorized person

pečat / stamp

Prodato u firmi / Company of Sale

Adresa / Address

Telefon / Phone

Datum prodaje / Date of Sale

Potpis / Signature

pečat / stamp

*Potrošač ima sva prava na osnovu Zakona o zaštiti potrošača ("Sl. glasnik RS", br. erbia62/2014). Garancija ne isključuje niti utiče na prava potrošača koja proizilaze iz zakonske odgovornosti prodavca za nesaobzirnost robe u ugovoru./ The consumer shall exercise all rights under the Consumer Protection Law ("OJ of RS" No 62/2014). The guarantee does not exclude nor affect the consumer's rights derived from the legal liability of the seller for any lack of conformity of the goods under a Contract.

*Gore navedeno važi za kupce na prostoru Republike Srbije./ The aforementioned applies to purchasers of the Republic of Serbia.

*Gore navedeno važi za kupce na prostoru Republike Srbije./ The aforementioned applies to purchasers of the Republic of Serbia.