

For more detailed PDF instructions scan the QR code.

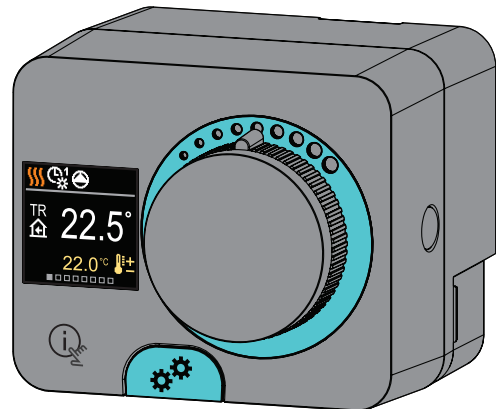

Compact weather compensated controller

AHD20



The AHD20 is a compact, weather-compensated heating controller built into the actuator housing. It allows direct mounting on more than 20 mixing valves from various manufacturers. The controller can also be used in systems without an outdoor sensor, but then the use of a room unit is mandatory.

### Appearance of the controller

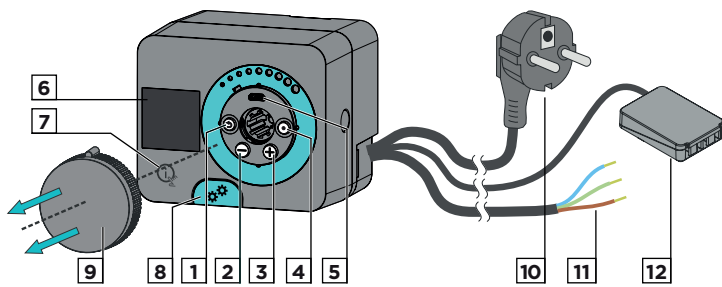

1. Button . Return back.
2. Button . Move to the left, decreasing.
3. Button . Move to the right, increasing.
4. Button . Menu entry, confirmation of selection.
5. USB port for software updates and connection to a personal computer.
6. Graphic display.
7. Button . Help.
8. Manual operation clutch.
9. Manual movement button.
10. Pre-wired power cord with plug.
11. Pre-wired cable for circulation pump.
12. Pre-wired connection box for sensors and communication.

### Controller installation

In a warm interior, the controller can be mounted directly on the mixing valve with the help of the accessories provided. Avoid close proximity to any strong electromagnetic fields.

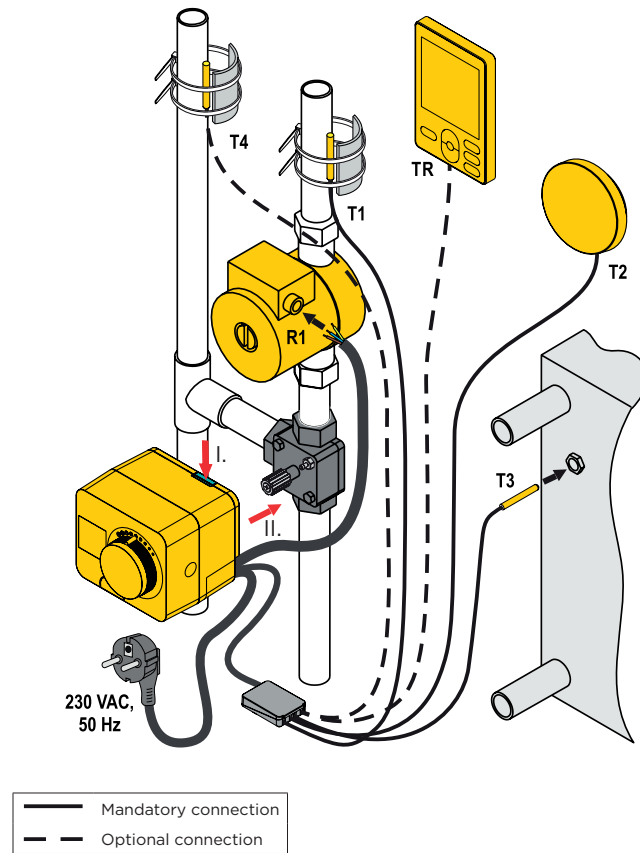

### Hydraulic schemes

#### Schema 360 - heating circuit

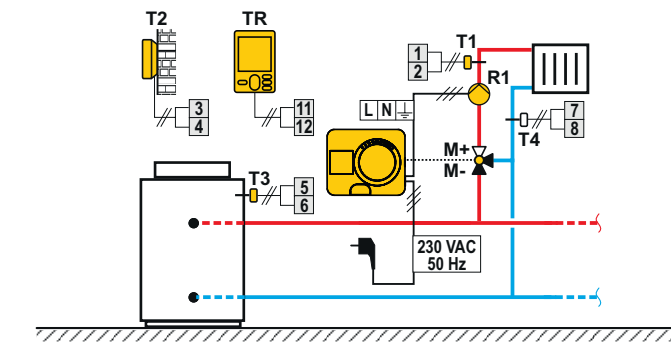

#### Schema 360b - additional heating circuit

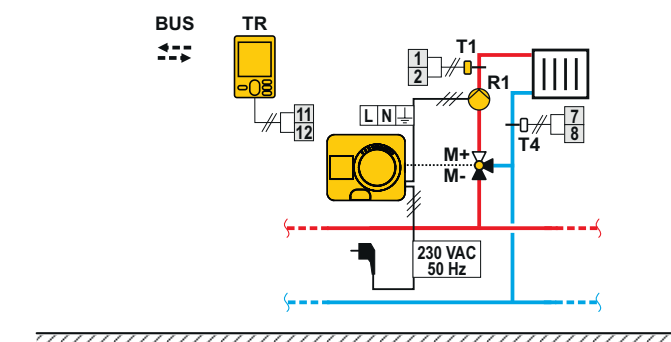

- Mandatory sensor
- Optional sensor

### Controller power connection

#### Connection of temperature sensors

The controller allows the connection of four Pt1000 temperature sensors (connection terminals 1 to 8). The sensor function depends on the hydraulic diagram and setup of parameters S1.6 and S1.7. One room unit can be connected to one controller.

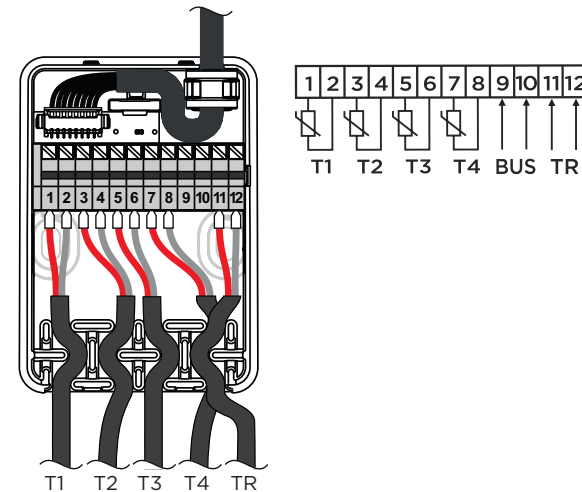

### Initial controller setup

The controller is equipped with an innovative "Easy start" function, which allows the initial setting of the controller in just four steps. Upon the first connection of the controller to the power supply network, the first step of the controller setup is displayed after the program version and logo. The manual movement button must be removed for the setup. The Easy start function is activated by pressing the buttons and and holding them both down together for 5 seconds.



#### Step 1 - language setup

Use the buttons and to select the requested language. Confirm the selected language by pressing . If you've mistakenly selected the wrong language, you can return to the language selection with the button.

Later, you can change the language in the „Display“ menu.

#### Step 2 - hydraulic scheme setup

You can select the hydraulic scheme for the controller operation. Use the buttons and to navigate between schemes. Confirm the selected scheme with the button. If you have mistakenly selected the wrong scheme, you can return to the diagram selection with the button.

Later, you can change the selected hydraulic scheme with the service parameter S1.1.

#### Step 3 - setup of heating curve steepness

You can set the heating curve steepness. The steepness can be set with the buttons and . Confirm the set steepness with the button . If you have accidentally set the wrong steepness, return to re-selecting the steepness with the button .

Later, you can change the steepness of the heating curve with the user parameter P2.1.

### Step 4 - selecting the opening direction of the mixing valve



You can select the opening direction of the mixing valve. Use the buttons and to navigate between directions. Confirm the selected direction with the button. If you have mistakenly selected the wrong direction, you can return to the direction selection with the button.

Later, you can change the opening direction of the mixing valve with the service parameter S1.4.

### Basic screens

All important data on the operation of the controller can be seen in the eight basic screens. Use the buttons and to navigate between the basic screens.

#### Status bar

Operation mode, notifications and alerts appear in the top third of the screen.

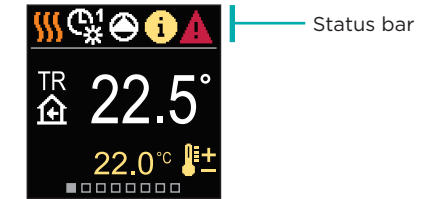

Symbol	Description
	Room heating.
	Room cooling.
	Operation according to program timer 1 - day temp.*
	Operation according to program timer 1 - night temp.*
	Requested day temperature operation mode.
	Requested night temperature operation mode.
	Switch off.
	Manual operation mode.
	Circulation pump is running.
	Turn the valve to the left.
	Turn the valve to the right.
	Manual intervention - the clutch is activated.
	PARTY operation mode.
	ECO operation mode.
	Holiday operation mode.
	Automatic heating switch off.
	Floor drying.
	Operation with constant stand-pipe temperature.
	Boost heating.
	AUX function at input T4.

**Message**  
In the event that the maximum temperature is exceeded or the safety function is activated, the controller notifies you with a yellow symbol on the display. When the maximum temperature is no longer exceeded or when a protection function has switched off, a gray symbol will turn on to note the recent event. The list of alerts can be viewed in the "Information" menu.

**Warning**  
In the event of a sensor or communication connection failure, the controller informs you of the error with a red symbol on the display. If the error is corrected or is no longer present, a gray symbol indicates a recent event. The list of errors can be viewed in the "Information" menu.

\* The number indicates the selected program timer

## Temperatures

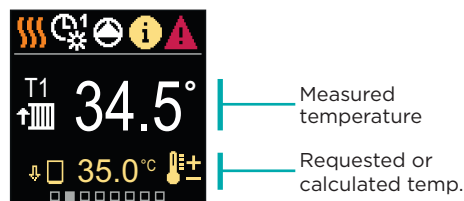

Measured temperature  
Requested or calculated temp.

Symbol	Description
	Calculated or requested temperature.
	Room temperature.
	Stand-pipe temperature.
	Outdoor temperature.
	Return-pipe temperature.
	Source temperature.
T1, T2, T3, T4	Temperature measured by sensors T1, T2, T3 and T4.
TR	Temperature measured by a room sensor or room unit.
TA	Outdoor temperature, obtained through the bus connection.
TQ	Heat source temp., obtained through the bus connection.
Error	Temperature sensor error.
- - -	Temperature sensor not connected.
	Limitation of heating circuit temperature due to the unsurpassed heat source temperature.
	Limitation of the heating circuit temperature due to exceeding the maximum difference between the stand-pipe and return-pipe or exceeding the maximum power of the heating circuit.
	Limitation of heating circuit temperature due to the ED regulation.
	Heating circuit is switched off due to priority of d. h. w. warming.
	Rise of heating circuit temperature due to the exceeded protection temperature of the heat source.

## Protective functions

The screen shows the selected hydraulic scheme with the display of measured temperatures. When the protection function is active, the corresponding symbol turns yellow. The notification symbol in the status bar also turns yellow.

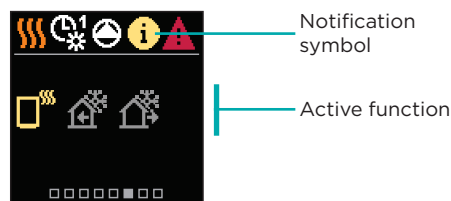

Notification symbol  
Active function

Symbol	Description
	Heat source overheating protection.
	Frost protection due to low room temperature.
	Frost protection due to low outdoor temperature.

## Hydraulic scheme

The screen shows the selected hydraulic scheme with the display of measured temperatures.

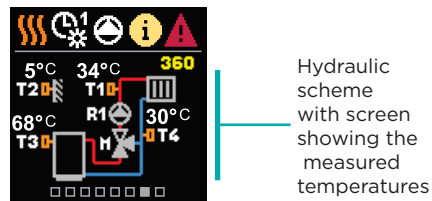

Hydraulic scheme with screen showing the measured temperatures

## Time and date

The screen shows the day of the week, the current time and date.

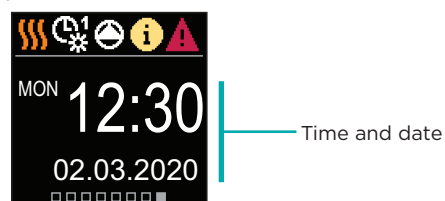

Time and date

## Help

By pressing the button we can start the display animation, which leads us to the additional settings menu.

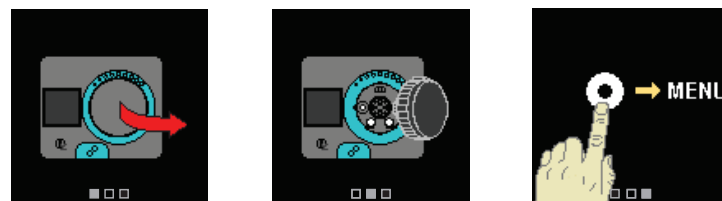

## Entering and navigating through the menu

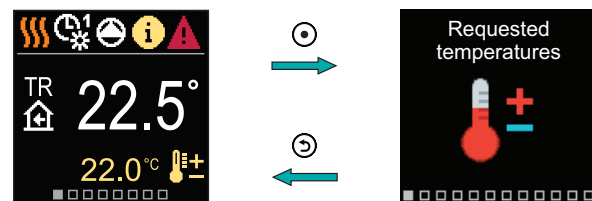

Press the button to enter the menu. Navigate through the menu with the and buttons and use the button to confirm your selection. Press the button to return to the previous screen.

## Requested temperatures

In the menu, you can change the setting of the requested temperatures.

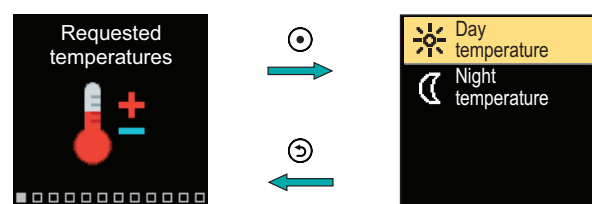

Navigate through the menu with the and buttons and use the button to confirm your selection. A new screen with temperatures will open.

## Requested day temperature

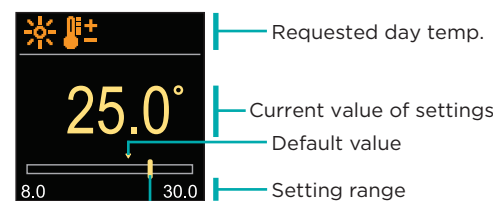

Requested day temp.  
Current value of settings  
Default value  
Setting range  
Current value of the requested temperature

Use the and buttons to select the requested temperature and confirm it with the button. Exit the setting with the button.

## User functions

User functions enable additional comfort and benefits of using the controller.

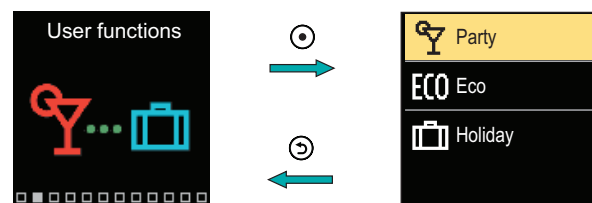

Navigate through the menu with the and buttons and use the button to confirm your selection. The screen for turning on and setting the user function opens.

## Party user function

The PARTY function activates the operation according to the requested comfort temperature until the set end time.

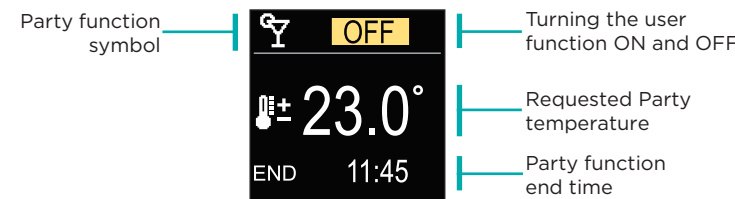

Party function symbol  
Turning the user function ON and OFF  
Requested Party temperature  
Party function end time

With the buttons and you can change the setting value and with the button you can move on to the next setting.

## Operation mode

In the menu, you can select the requested operation mode and other operation options.

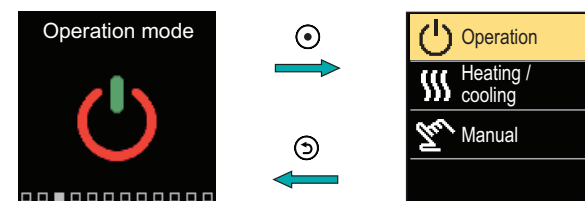

Navigate through the menu with the and buttons and use the button to confirm your selection.

## Operation selection

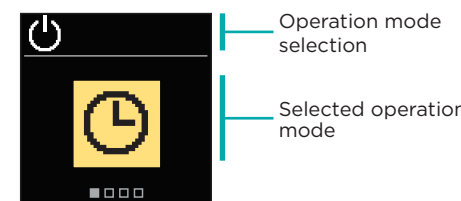

Operation mode selection  
Selected operation mode

Use the buttons and to select the requested operation. Exit the setting by pressing or .

Symbol	Description
	Operation according to the selected time program with day and night temperature which is set on the controller.
	Requested day temperature operation mode.
	Requested night temperature operation mode.
	Switch-off. Frost protection remains active, if operation mode heating is selected. The overheating protection remains active, if operation mode cooling is selected.

## Time programs

Weekly time programs enable automatic switchover between day and night temperature. There are two time programs available. A check mark next to the time program tells which time program is selected for operation.

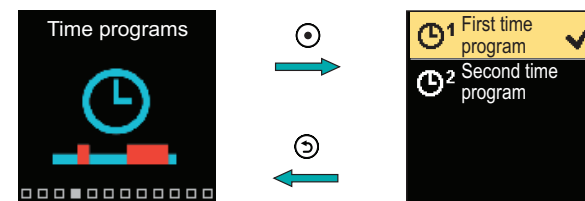

Navigate through the menu with the and buttons. With the button you can select the time program for operation and with the button you can enter the setting of the selected time program.

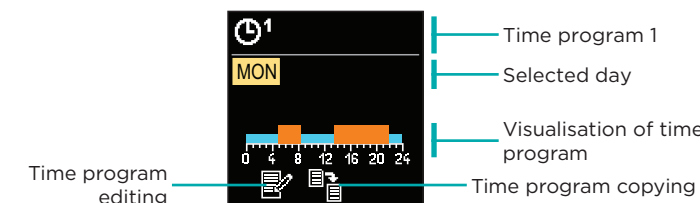

Time program 1  
Selected day  
Visualisation of time program  
Time program copying

With the buttons and you can select the day for which you want to edit or copy the time program and confirm it with the button . Now, with the buttons and select the icon to edit or copy the time program and confirm it with the button .

Default settings of time programs:

	Mon - Fri	05:00 - 07:30 and 13:30 - 22:00
	Sat - Sun	07:00 - 22:00
	Mon - Fri	06:00 - 22:00
	Sat - Sun	07:00 - 23:00

## Time program editing

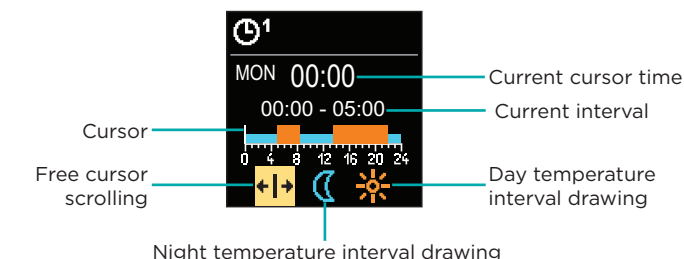

Current cursor time  
Current interval  
Day temperature interval drawing  
Night temperature interval drawing  
With the button select the requested icon to scroll or draw the interval, using the buttons and you can draw the requested course of the time interval. Exit the time program editing by pressing the button .

## Time program copying

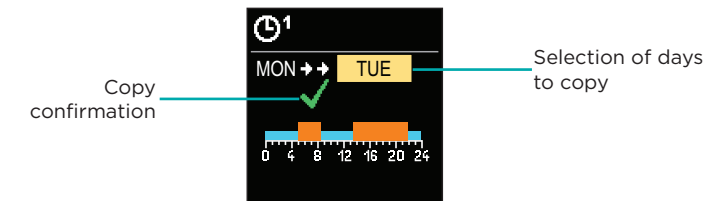

Selection of days to copy  
Copy confirmation  
With the buttons and you can select the day for which you want to edit or copy the time program of the displayed day. Confirm the time program copying by pressing the button . Exit the time program copying by pressing the button .

## Clutch and manual valve displacement

Pressing the clutch I. activates the manual valve displacement. You can now move the mixing valve by turning the button II. To return to automatic operation, press the clutch I. again. When the clutch is activated, the clutch symbol appears on the display.

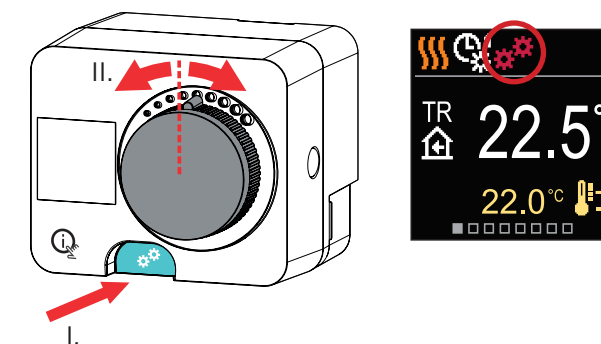

Copyright © 2020 Seltron

This user manual is protected by copyright laws. No part of this document may be reprinted, reproduced, translated or copied to a system used for storage and retrieval of data by electronic or mechanical means, photocopying, recording or storing without the written permission of Seltron. We reserve the right to make changes or errors.

Seltron d.o.o.  
Tržaška cesta 85 A  
SI-2000 Maribor  
Slovenia

T: +386 (0)2 671 96 00  
F: +386 (0)2 671 96 66  
sales@seltron.eu  
www.seltron.eu



01MC060606

N7060008 v1.0  
Program v1.0r0