



Three speed pumps | export model*

WITA U 55

Product specials

- Warranty
- Cataphoresis coated pump housing



Technical Data

Max. pump lift	6 m
Max. flow rate	3.700 l/h
Power consumption	39 - 80 W
Supply voltage	1 x 230V, 50 Hz
Ip rating	IP 42
Ambient temperature	0 °C to +40 °C
Media temperature	+5 °C to +110 °C
Temperature class	TF 110 as per CEN 335-2-51
Max. system pressure	10 bar
Connection size	DN 15, DN 20, DN, 25, DN 32
Installation lengths	110 mm, 130 mm, 180 mm
Pump housing material	variant in grey cast iron, cataphoresis coated, Brass
Weight incl. insulation	2.5 kg

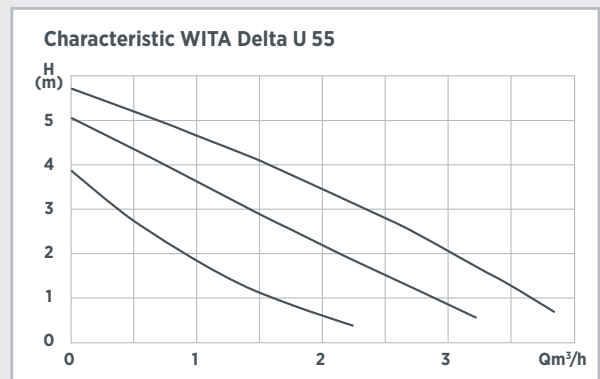
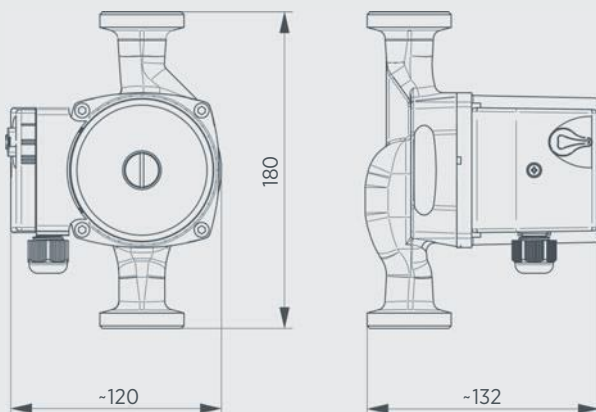

* available only outside the EU